

TECHNICAL PROPOSAL

GLX Constructors is one team with one goal – to design, build, and commission the Green Line Extension. Our team has working relationships from past projects, and also offers the strongest combination of local and national transit-oriented contractors with proven experience in Design Build delivery of transit systems; integration of new and existing rail systems; start-up, testing, and commissioning; and extensive community outreach.

On the following pages, you will find a summary of our technical proposal submission.

Conceptual Draft
For Discussion
Purposes Only

Conceptual Draft
For Discussion
Purposes Only

Conceptual Draft
For Discussion
Purposes Only

Conceptual Draft
For Discussion
Purposes Only

MANAGEMENT APPROACH



During the preparation of our Statement of Qualifications and as part of our proposal development, GLX Constructors has built an experienced Project Team based on the needs of the Project. Our team was assembled with the expressed goal of developing a Management Approach to incorporate the initial design of the Project with how the Project will be constructed and commissioned. Our construction-driven approach drives our collaborative team integration, providing the MBTA with a fully integrated Project Team to deliver cost and schedule certainty.

Our construction-driven approach to Project Management begins during the Design Phase of the Project and integrates safety, quality, construction, and commissioning into the heart of the Project.

Our Management Approach demonstrates:

- ▶ A clear understanding of the Project with a proven approach to managing quality; safety, security, and emergency management; risks; and schedule.
- ▶ Our approach to construction while minimizing impacts to the traveling public, the MBTA, and rail operations.
- ▶ Our approach to controlling costs and minimizing claims and delays, as well as resolving disputes.



A construction-driven approach will minimize interruptions and impact on the community, optimize schedule, maximize quality and efficiency. Schedule and cost certainty are a product of a construction-driven approach.

DESIGN MANAGEMENT



Construction-driven approach drives cost and schedule efficiencies in a collaborative environment.

GLX Constructors' Lead Designer, STV, brings local and national expertise in Design Build project delivery, including the successful completion of some of the most complex, large-scale transportation projects in Massachusetts and the United States.

Mark Pelletier, PE, Design Manager, will lead the Design Team. He brings his valuable experience working with the MBTA and other GLX Constructors' team members to the Project. He has designated experienced personnel and design subconsultants to efficiently complete the Project from design through safety certifications, revenue operations, and closeout.

To ensure overall project integration and schedule certainty, GLX Constructors has appointed an additional team member to serve in a critical role to oversee and collaborate with the Design Team. Michael Hoytink, our Design Build Coordinator, brings more than 15 years of experience on similar DB projects. This role provides the team with a designated individual for all activities between the design and construction team.

As part of our construction-driven approach, Mark Pelletier has built a team of Design Discipline Leads that will work alongside the Construction Discipline Project Engineers and Superintendents to develop a comprehensive design solution that will be implemented through construction, testing, and commissioning.

To effectively and efficiently manage the design phase, we have divided the design submission into 10 categories and will dedicate a Discipline Design and Construction lead to each package. Each package will be managed through our Technical Work Groups (TWG). TWGs will be composed of the Design Discipline Leads, Construction Discipline Leads, the MBTA, and the appropriate third-party stakeholders. The 10 TWGs will interact both formally through regularly scheduled meetings, and informally on a daily basis at the co-located office. By embedding the Construction Team, the MBTA, and third-party stakeholders into the TWGs, we advance our design and Technical Solutions in a cohesive manner, and we immediately address any potential issues surrounding constructability and work phasing during design development.

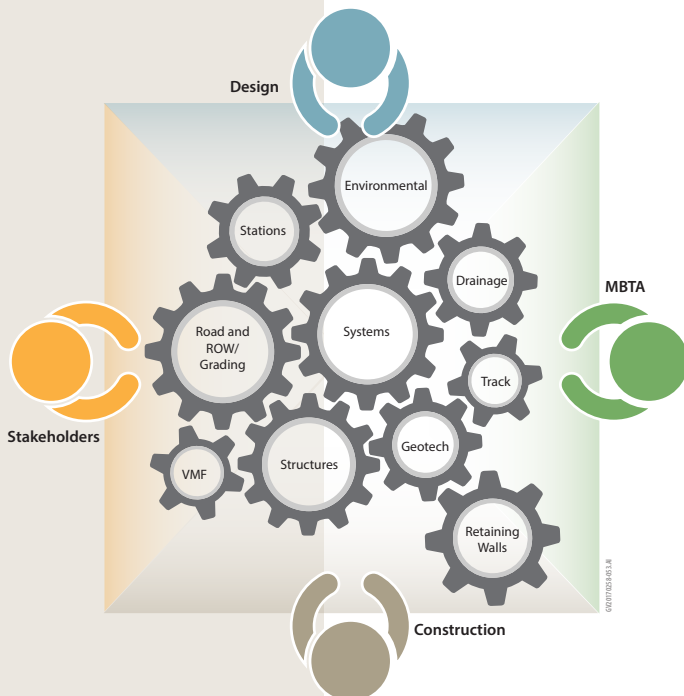

CONSTRUCTION MANAGEMENT

Experience is so important when it comes to construction, but proper teamwork is essential to drive the Project to success and exceed expectations. As such, GLX Constructors' team members have been working together since late 2016 to meet the goals and objectives of the Project. In addition, two members of our team competed for the Project in the initial 2012 CM/GC procurement. We are pleased to have the opportunity to build this project.

The execution of the Green Line Extension DB Project is led by our Project Manager, John West, and Construction Manager, Jamie Doyle. Combined, these gentlemen bring decades of DB experience to the Project.

In addition, we have formed a team that has the added benefit of having prior working relationships, including the successful completion of the Greenbush Line Rail Restoration Design Build Project for the MBTA. This experience of working together on prior projects provides the MBTA and the Project with an already-established communication and coordination system, and eliminates a learning curve that is typically in place at the start of a project.



Design Manager, Mark Pelletier, and Construction Manager, Jamie Doyle bring their past experience working together on the Greenbush Line Rail Restoration to the Green Line Extension.



GLX Constructors' team members have formed an integrated team that has the added benefit of having a prior working relationship to successfully complete the Greenbush Line Rail Restoration Design Build Project for the MBTA.



Conceptual Draft
For Discussion
Purposes Only

Conceptual Draft
For Discussion
Purposes Only



GLX Constructors’ team members have been actively involved in many transit Safety and Security efforts for successful transit system projects nationwide, including Dallas Area Rapid Transit, Houston Metro Rail, Denver Regional Transport District, LAMTA, UTA, and WMATA (Dulles Phase 2), along with task order work for agencies such as Amtrak, BART, and Hampton Roads Transit.

QUALITY MANAGEMENT

We have specifically developed our Quality Management Plan to complement the MBTA’s Quality Management Plan, which is well known and understood by our team members. We have an owner-operator approach to quality management. GLX Constructors has an ISO 9001-compliant Quality Management Plan that is aligned with our Project Management Plan and incorporates our staff members’ NETTCP and ASQ quality management certifications.

Our Quality Team is independent from the Construction Team. The Quality Team reports directly to the Project Executive, the Executive Committee, and the MBTA on the same reporting level as the Project Manager. In this manner, the MBTA has immediate confirmation of quality concerns and approvals, providing confidence in the integrity of the Quality Management System and a close oversight of our quality performance.

SAFETY, SECURITY, AND EMERGENCY MANAGEMENT

GLX Constructors will further assess the Project’s requirements and develop a Safety, Security, and Emergency Management Plan. We will provide the MBTA with a fully compliant program that comprises safety, security, and emergency elements for protecting both the MBTA’s operations, workforce, and the commuting public during day-to-day public use once the Project is successfully completed. Our Team has extensive startup, commissioning, testing, and systems certification experience, and we apply our best practices during the Design and Construction Phases for systems testing and commissioning, facilitating an effective Project start up and reduced costs along the way.

RISK MANAGEMENT

Supporting the MBTA's Project goals surrounding cost and schedule certainty, GLX Constructors offers the MBTA a risk management process that will minimize and manage risks that may threaten the Project's success. Our team will identify, assess, monitor, mitigate, and manage Project-specific risks during each Project phase and activity. As a result, the MBTA can rest assured that we will live up to our goal of "no surprises" for the MBTA; maintaining cost and schedule certainty from Design through the Construction, Testing, Commissioning, and Startup Phases of the Project.

GLX Constructors will engage local agencies and stakeholders through our TWGs and regularly scheduled meetings during the planning stages of both design and construction, so we may address concerns early and proactively.

Through our extensive experience in DB project delivery, GLX Constructors has defined a systematic approach that enables us to effectively identify risks, assign management of those risks, and mitigate any potential risks of impacting the Project. These risks incorporate the MBTA risks as well. We have established a Risk Management Plan to minimize and manage risk. This plan is a project-specific implementation of GLX Constructors' managing partner, Fluor's Business Risk Management Framework (BRMF). This process has been effectively used on previous DB projects performed by GLX Constructors' team members, and will help to ensure the project is delivered on schedule and under budget.

SCHEDULE CERTAINTY

Since our SOQ submittal in early 2017, GLX Constructors has invested tremendous resources in the Green Line Extension DB Project. We have performed an in-depth schedule analysis to fully assess the design and construction challenges of the Project. While performing these activities, we focused on the MBTA's milestones, objectives, and activity restrictions. In establishing our Initial Baseline Schedule, we have coordinated the scope of all Project-related activities to ensure schedule certainty, identify potential risks, and implement appropriate mitigation measures to address any concerns from the MBTA and local municipalities.

COST CERTAINTY

The MBTA has delivered a clear message that the Green Line Extension DB Project will be financially successful. The system has many capital needs and priorities competing for these precious project funds. Cost certainty is a clear Project goal, and one that we embrace as we partner with the MBTA to support and work to bring the best value to the Commonwealth and transit ridership.

TECHNICAL SOLUTIONS



SYSTEMS

GLX Constructors has developed an efficient and innovative design and construction solution which demonstrates our understanding of the overall Project requirements. Details of our approach to each of the Technical Solutions and the benefits of our approach are more fully explained in our Technical Proposal.

- ▶ GLX Constructors' Lead Designer has more than 35 years of experience with the MBTA and understands the current systems in place as well as the proposed system to allow for seamless integration.
 - ◆ STV has one of the largest systems groups in the Boston area and in the country with many professionals that have worked for and with the MBTA for 30+ years.
- ▶ GLX Constructors has a dedicated group of local systems and integration professionals to bring their lessons learned from prior relevant projects to this Project to ensure cost and schedule certainty.

ELEVATED GUIDEWAY AND STRUCTURES



- ▶ To reduce cost and improve aesthetics, we have lowered the elevation of the guideway.
- ▶ For a more efficient foundation design, we will use driven piles, which will also limit the impacts associated with excavating contaminated soils.
- ▶ In order to increase design optimization, we have avoided the need for concrete counter weighting in curved superstructures supporting single track.
- ▶ Through our approved ATC No. 36, the underpass at Walnut Street has been completely eliminated which will bring cost savings to the Project.
- ▶ We provide a more reliable and standardized approach by replacing the underpass structures with back spans at Medford Street and School Street Bridges.
- ▶ Our approach provides a shorter duration to replace one span.
- ▶ We maximized the use of precast concrete elements for retaining walls, which are cost effective and have a 75-year design life.



STATIONS

- ▶ GLX Constructors developed a unique approach at Gilman Square Station which provides better connectivity to the Community Path, provides improved access to both School Street and Medford Street to the station, and eliminates the need for an elevated walkway between the tracks.
- ▶ ATC No. 36 raises the elevation of the Community Path at Gilman Square Station which will improve public access to the station.

LANDSCAPING AND STATION SIGNAGE

- ▶ GLX Constructors' design provides opportunities for branding at each station and will utilize the MBTA's well-established standards for signage.
- ▶ Our approach offers clear wayfinding for separating the riders from the Community Path.
- ▶ GLX Constructors understands the existing vegetation along the Project alignment and our design incorporates low maintenance and drought-tolerant landscaping components.



VMF

- ▶ Our design and construction approach to the VMF maximizes function and productivity.
 - ◆ We have removed the longitudinal column line between Tracks 1 and 2, which optimizes the space, provides flexibility for positioning equipment, and increases working envelopes for personnel.
 - ◆ Three lateral column lines have been removed to allow us to reposition the remaining column lines to eliminate potential interference with personnel and equipment to move throughout the area, especially between Tracks 3 and 4 and the maintenance and storage areas.
- ▶ Our design includes a lowered and simplified roof line, which reduces construction and maintenance costs.
- ▶ The floor elevation was raised to eliminate flood plain issues and maximize reuse of the excavated soils from the Project, thereby minimizing costly soil disposal.

CIVIL & GUIDEWAY

- ▶ GLX Constructors optimized the track both vertically and horizontally to simplify its construction which minimizes excavation and reduces exposure to risk from hazardous materials and trucking.
- ▶ We optimized the Community Path design to maximize its width and provide better accessibility for the public.
- ▶ Through the approved ATC No. 36, our approach increases the number of opportunities to access the Community Path at street levels from the surrounding communities.
- ▶ The horizontal and vertical track realignments have reduced the degree of curvature, thereby allowing increased train speeds.
- ▶ In our design approach, we shifted the tracks at the Washington Street Bridge to eliminate stacking of the Community Path which improves safety and security for the path users.

DRAINAGE

- ▶ GLX Constructors has optimized the drainage design to shift the drain lines to minimize impacts to the active commuter rail line.
- ▶ Through our past experience with the MBTA, our team has a thorough understanding of the site-wide drainage system and the permitting requirements.



We have optimized the track both vertically and horizontally, reducing the amount of soil to be removed from the ROW, thus resulting in reduced exposure to risk from hazardous materials and trucking.



ALTERNATIVE TECHNICAL CONCEPTS

We expended significant time and effort looking for Project innovations and optimizations to improve cost and schedule certainty while maintaining quality. These efforts resulted in the following formal ATCs that have been incorporated into our proposal, providing additional benefits to the MBTA.

ATC NO. **12**

PROJECT AREA
STRUCTURES

DESCRIPTION

Use of OCS Poles on the outside of the tracks on new viaduct structure

VALUE TO THE PROJECT

- ▶ Reduction of viaduct deck width
- ▶ Decreased deep foundation dead loads
- ▶ Improved maintenance access
- ▶ Elimination of walkway obstructions

ATC NO. **35**

PROJECT AREA
CIVIL

DESCRIPTION

Replacement of three sections of elevated track with MSE walls south of Washington Street

VALUE TO THE PROJECT

- ▶ Elimination of deep foundations and associated risks with unforeseen conditions
- ▶ Reduction of maintenance for elevated structure and associated bridge deck area
- ▶ Increased service life of MSE wall sections

ATC NO. **36**

PROJECT AREA
CIVIL

DESCRIPTION

Improved Community Path, accessibility, and public safety

VALUE TO THE PROJECT

- ▶ Increased safety and security of Community Path users
- ▶ Elimination of Walnut Street pedestrian underpass
- ▶ Elimination of underpass Fire and Life Safety features
- ▶ Reduction of Medford Street underpass width
- ▶ Elimination of underpass lighting at Walnut Street and Medford Street
- ▶ Improved accessibility for emergency and maintenance vehicles operating on the Community Path
- ▶ Eliminates relocation of 48" MWRA waterline at Walnut Street

ATC NO. **43**

PROJECT AREA
TRACK

DESCRIPTION

Reduction of subballast sections through use of a filter fabric and geogrid reinforcement

VALUE TO THE PROJECT

- ▶ Limits ballast settlement and lateral creep
- ▶ Reduces excavation and export of potentially contaminated soils
- ▶ Reduces trucking impacts to local streets; expedite installation
- ▶ Increases service life
- ▶ Reduces ballast maintenance

KEY PERSONNEL

GLX Constructors has developed a strong project organization that possesses the expertise, leadership, and depth of experience to successfully deliver the Project to the MBTA and stakeholders. Our proposed team is comprised of leaders in the rail industry who have prior successful experience working together.

The majority of this team, including John West, Jamie Doyle, Clyde Joseph, Mark Pelletier, Aaron Neeley, and Lloyd Lovell have been working on the pursuit of this Project since shortly after submission of our Letter of Interest, with several having been dedicated full-time since shortlisting. They have developed the necessary project knowledge, synergy, and inter-personal relationships necessary in all successful teams, and will undoubtedly provide the MBTA with an outstanding combination of dedication, professional knowledge, experience, and the partnering approach needed to make this project a success for all.



Clyde Joseph
Project Executive



John West
Project Manager



Jamie Doyle
Construction Manager



Mark Pelletier, PE
Design Manager



Bob Horn
Project Controls Manager



Sandro Plutino
Quality Manager



Hannah Brockhaus
Title VI Program Lead



Hannah Carmical
EEO Compliance Lead



Lloyd Lovell
DBE Compliance Lead



Michael Hoitink
Design Build
Coordinator



Chris Poe
Project Safety and
Security Manager



Aaron Neeley
Systems Integration
Manager and Testing and
Commissioning Manager

CIVIL RIGHTS

While the Project is a large-scale, heavy-civil construction project, it is also a deeply rooted community project, constructed through a densely populated urban environment. GLX Constructors is committed to exceeding the MBTA's expectation by integrating local vendors, subcontractors, and service providers into our team and communicating effectively to the surrounding communities to minimize disruption, inform them of our progress, and contribute to the overall Project's success.

DBE PLAN

GLX Constructors is dedicated to creating meaningful and growth-oriented opportunities for disadvantaged and minority-owned businesses. We commit to staffing the project with a diverse and highly-qualified workforce in order to create a level playing field on which small and disadvantaged businesses will compete fairly. To drive this, we have appointed Lloyd Lovell as the DBE Compliance Lead. Lloyd develops, implements, and manages Small, Minority, Women, and Disadvantaged Business Enterprise Programs.

WORKFORCE/EQUAL EMPLOYMENT OPPORTUNITIES

GLX Constructors shares the MBTA's value of promoting diversity in the workplace and on its projects. Our team is committed to achieving a diverse workforce and providing an environment where all employees are treated fairly and with respect.

TITLE VI PROGRAM COMPLIANCE

GLX Constructors will tailor our outreach to engage the entire community, including minorities and non-English speakers. To strengthen our team's efforts, we have engaged Hannah Brockhaus with Howard Stein Hudson (HSH) as the Title VI Program Lead. HSH routinely provides Title VI Program development, implementation, and management services to the MBTA and MassDOT on a wide variety of construction projects, including the recent Chelsea Viaduct Rehabilitation Project. Using these lessons learned, Hannah will work with community members to go beyond the traditional public information meeting to ensure that all members of the community are equally well informed about the advancing construction and how it will affect their daily lives, and how they can participate and benefit from this Project.



GLX Constructors will bring lessons learned from managing diverse workforces on many comparable DB and rail projects, including:

- ▶ **Eagle P3 Commuter Rail Line, Denver, Colorado, \$3 billion**
- ▶ **Greenbush Line Rail Restoration Design Build, Massachusetts, \$334 million**
- ▶ **West Rail Line, Denver, Colorado, \$438 million**
- ▶ **495 Express Lanes, Northern Virginia, \$1.4 billion**

WHY GLX CONSTRUCTORS?



GLX Constructors delivers local knowledge, MBTA working relationships, and demonstrated rail and Design Build (DB) expertise. We offer the experience necessary to meet the primary goals for the Project listed in the RFP, including:

LOCAL EXPERIENCE WITH MBTA

GLX Constructors' team members, Middlesex and STV, have an established local presence in Boston, and have partnered with the MBTA for more than 35 years.

DESIGN BUILD EXPERTISE

GLX Constructors has delivered more than \$30 billion in complex DB projects, including STV and Balfour Beatty's experience on the Greenbush Line Rail Restoration DB Project, the first large-scale DB project for the MBTA.

EXPERIENCE WORKING TOGETHER

Our team members and proposed key personnel have experience working together on large, complex transportation projects and with the MBTA.

COMPLEX RAIL EXPERIENCE

GLX Constructors' team members have individually and collectively delivered rail projects in dense urban environments including active rail and integration with new and existing systems; and extensive experience with start-up, testing, commissioning, and FTA safety certification.

EXTENSIVE COMMUNITY INVOLVEMENT

GLX Constructors is committed to exceeding the MBTA's expectation. We have experienced and dedicated resources to make a positive long-term impact on the local communities.

Conceptual Draft
For Discussion
Purposes Only

Conceptual Draft
For Discussion
Purposes Only

Conceptual Draft
For Discussion
Purposes Only

Response to the Request for Proposal for the Green Line Extension Design Build Project

Submitted to
**Massachusetts Department of Transportation and
The Massachusetts Bay Transportation Authority**

Part 2 – Financial Pass/Fail Evaluation Criteria Information



Conceptual Draft
For Discussion
Purposes Only

Conceptual Draft
For Discussion
Purposes Only



Response to the Request for Proposal
for the Green Line Extension Design Build Project

Submitted to
Massachusetts Department of Transportation and
The Massachusetts Bay Transportation Authority

Part 3 – Management Approach Qualitative Evaluation Criteria Information



TABLE OF CONTENTS



PART 3 →

- Section 3.1 Project Management Plan
- Section 3.2 Quality Management Plan
- Section 3.3 Safety, Security, and Emergency Management
- Section 3.4 Risk Management Approach
- Section 3.5 Initial Baseline Schedule

3. MANAGEMENT APPROACH QUALITATIVE EVALUATION CRITERIA INFORMATION



Construction-driven execution of Project Management delivers a safe, quality, and economical Design Build Project providing the best investment value for the MBTA.

During the Proposal Phase, Fluor, Middlesex, Herzog, and Balfour Beatty, along with STV, have revisited our past, successful projects that are similar in complexity, scope, and nature to generate efficiency for this Project.

3.1 PROJECT MANAGEMENT PLAN

GLX Constructors is a versatile team that offers the MBTA the essential knowledge, capability, and systems to maintain both cost and schedule certainty on the Green Line Extension Design Build (DB) Project. From managing third parties, integrating our Design and Construction Teams, and implementing critical project controls, GLX Constructors' local experience will give the MBTA an aggressive price and the best value for its investment. In working with GLX Constructors, the MBTA can expect value in the form of a reliable work plan, transparent communication, quick and seasoned problem solving, and a fully resource-loaded critical path schedule that will maintain existing rider capacity throughout construction.

GLX Constructors will deliver a collaborative approach with the MBTA and Project Stakeholders to successfully execute this transformative infrastructure project. Key members of our Project Team have been involved in the delivery of this Project beginning with the SOQ and Proposal Phases, and we remain committed to continue through the Execution Phase. This transition of our integrated Key Personnel from the Proposal Phase into the Execution Phase, along with our project management procedures, processes, systems, and structures will enable our Team from day one to be fully focused on the MBTA's Design Build (DB) objectives, the Green Line's specific challenges, key result areas, and our successful partnership with the MBTA.

GLX Constructors applies a construction-driven approach to project management, beginning with integrating our health, safety, and environmental (HSE), quality, and construction standards into each phase of the Project, including the Design Phase. Safety for our workforce, Management Team, Design Team, the MBTA, and the traveling public is the first and most critical aspect of our project management approach.





To enhance time and cost savings for the MBTA, we will include a senior-level DB Coordinator as a liaison on our team. By doing so, we will smooth the interfaces between design and construction activities and seamlessly integrate a construction-driven execution across design disciplines.

To provide for the most economical design and facilitate efficient construction execution done right the first time, our quality systems, discussed in detail in Section 3.2, are implemented at the onset of project execution in cohesion with our Construction Management Team, project engineers, and superintendents within the Technical Work Groups (TWGs), discussed in further detail in Section 3.1.B. This integrated process allows for an efficient transition from the Design Phase into the Construction Phase, minimizing learning curves for the construction execution personnel. Because our Construction Team Leadership has been heavily involved in developing our Technical Solutions, our Team is ready and capable to construct the proposed and approved plans for the Project. Our commitment of these resources during the front end of the Project (approximately 15 percent) provides invaluable benefit to the primary Construction Phase (approximately 85 percent) and delivers a safe, quality, and economical solution for the MBTA, which allows for greater schedule certainty in completing the Project under the required timeline.

After project award, we will finalize the following site-specific plans that are compliant with the Technical and Contractual Provisions:

- ▶ Project Management Plan
- ▶ Project Execution Plan
- ▶ Quality Management Plan
- ▶ Safety, Security, and Emergency Management Plan

The following section details our Initial Project Management Plan.

3.1.A GLX CONSTRUCTORS' ORGANIZATION CHARTS

Proposed Design Organization

GLX Constructors' Design Team, led by STV, is experienced in rail transit design and remains committed to the Project goals. Figure 3.1-1 illustrates the relationships among our Design Team, including their direct interfaces with our Construction Team. For the resumes of the Design personnel to the level of Design Discipline Leads listed in the Proposed Design Organization Chart, we have included summary resumes within this section. For further reference, we have included detailed two page resumes in Appendix 1 - Design Discipline Lead Resumes at the end of Section 3.1.

Members on our Proposed Design Organization Chart will be 100 percent committed to the Green Line Extension DB Project throughout the Design Phase, until we have transitioned out of the Design Phase and into the Construction Phase, during which time the Design Team members will take on a supporting role to the Construction Team. When in their supporting role, the Design Team's commitment to the project will remain, but their time commitments will decrease, reducing the resource costs over the Project life.

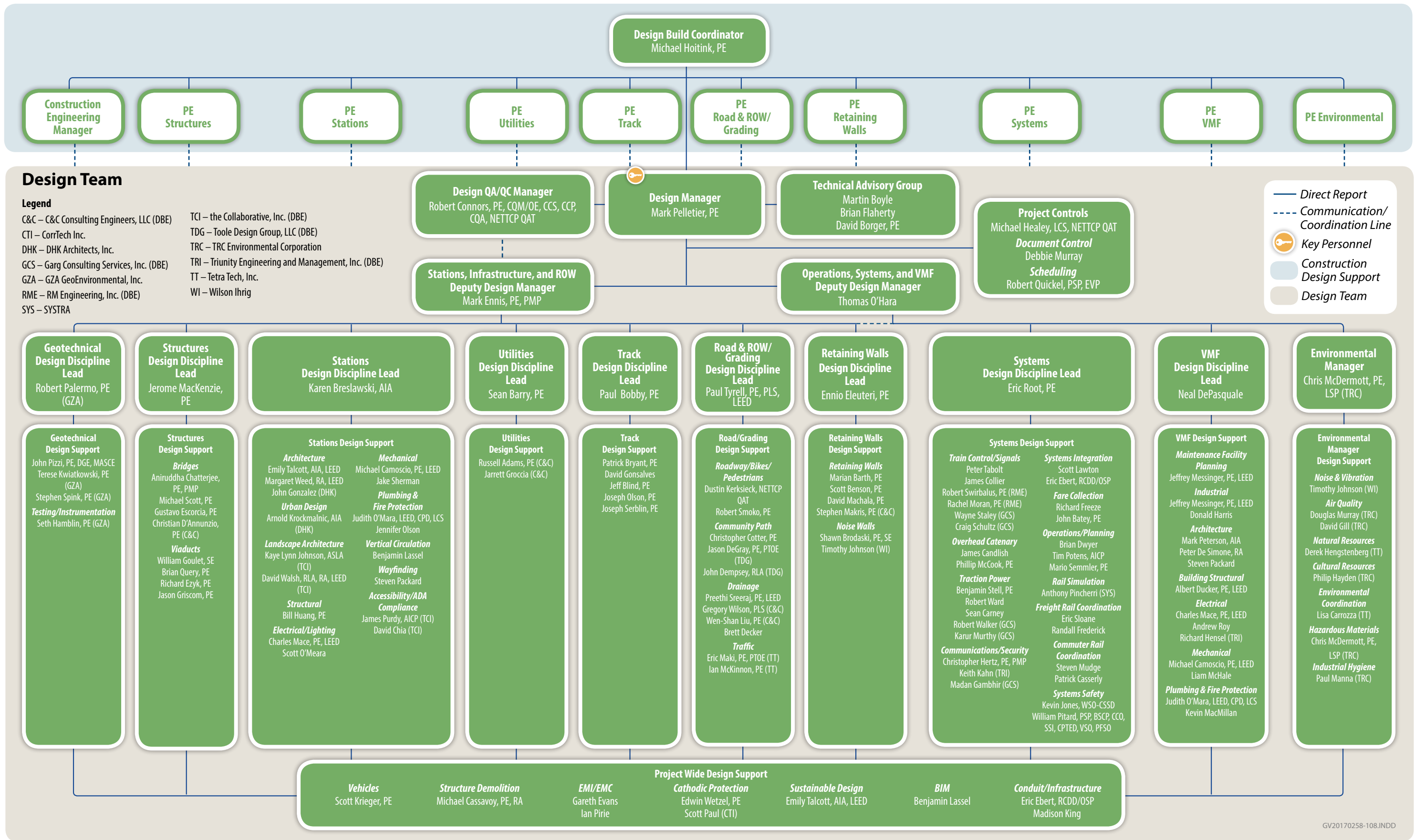

Figure 3.1-1. Proposed Design Organization. Our Proposed Design Organization chart illustrates our proposed design organization, indicating the responsibilities and structure of the design staff and independent design check staff, down to and including discipline leads and the staff positions proposed in each discipline.

Integrated Design and Construction Organization

Michael Hoytink, our Design Build (DB) Coordinator, will be a dedicated key lead for GLX Constructors, with the primary responsibility for fully integrating our Design Organization and execution with our Construction Team. Our Design Manager, Mark Pelletier, will report directly to Michael and retain responsibility for STV, our Lead Designer, and their subconsultants. Two Deputy Design Managers will support Mark:

- ▶ Mark Ennis, Deputy Design Manager, Stations, Infrastructure, and ROW
- ▶ Tom O'Hara, Deputy Design Manager, Operations, Systems, and VMF

Each Deputy Design Manager will lead multiple Design Discipline Leads who will initiate our TWGs. These TWGs are composed of:

- ▶ Design Discipline Lead, supporting the discipline designers
- ▶ Construction discipline Project Engineers and Superintendents
- ▶ The MBTA's discipline Technical Design Reviewers and appropriate third-party representatives

GLX Constructors' Safety, Quality, Environmental, Scheduling, and Cost Control Leads, as well as appropriate interdisciplinary design and construction personnel, will complete our TWG makeup.

This cross-pollination of all parties into the design effort secures the most cost-effective and efficient design solution with a focus on constructability. Early and active engagement – and focused collaboration of the construction, design, and interagency teams – is at the core of our construction-driven approach to design and construction execution.

Summary Resumes for Design Personnel

Sean Barry, PE, Utilities Design Discipline Lead

Education: B.S., Civil Engineering, University of Massachusetts, Amherst

Professional License/ Professional Engineer, MA #41802

Certification:

Sean has more than 20 years of experience in the design and construction phases of civil engineering projects. He has provided engineering services for numerous utility and roadway projects that have involved the installation of water, sewer, drainage, gas, power, and telecommunications improvements.

City of Somerville, Central Broadway/Winter Hill Roadway and Streetscape Improvements Study and Design, Somerville, Massachusetts, Project Manager. Sean oversaw the design of roadway and streetscape improvements to a 1-mile corridor. He coordinated efforts with STV traffic engineers and survey, landscaping, and public outreach subconsultants.

MBTA, Greenbush Line Rail Restoration Design Build, Braintree, Weymouth, Hingham, Cohasset, and Scituate, Massachusetts, Project Engineer. Sean prepared site layout grading and drainage designs, as well design packages for various at-grade roadway crossings and seven rail stations, for the restoration of this commuter rail line.



Communication and integration are crucial for successful execution.

MBTA, Wellington Carhouse Expansion and Improvements, Medford, Massachusetts, Lead Civil Engineer. Sean managed the development of civil plans and specifications for the MBTA's planned expansion and renovation of the Wellington Carhouse. His work involved coordinating with other design disciplines, including track, structural, electrical, traction power, plumbing, fire protection, and architectural professionals.

Town of Barnstable, Lincoln Road Reconstruction, Hyannis, Massachusetts, Project Manager. Sean is managing the development of plans for the \$1.5 million reconstruction of 0.75 mile of roadway between Route 28 and West Main Street.

Paul Bobby, PE, Track Design Discipline Lead

Education: B.S., Civil Engineering, University of Wisconsin/Platteville

Professional License/ Certification: Professional Engineer, Georgia # PE034469

Paul is a track designer with more than 15 years of experience in the design and construction of rail improvements.

City of Ottawa, O-Train Expansion, Ottawa, Ontario, Lead Track Engineer. Paul oversaw the design of track and acceptance inspection activities during the service expansion of the O-Train light rail transit system in Ottawa, Ontario.

IDOT, Granite City to St. Louis Corridor Phase I Environmental Studies, Granite City, Illinois and St. Louis, Missouri, Project Manager/Project Engineer. Paul is supervising preliminary engineering efforts for all work associated with the preparation of the Environmental Impact Study for the expansion of rail service between Granite City and St. Louis.

St. Louis Metro, East Riverfront Interlocking, St. Louis, Missouri, Project Engineer. Paul oversaw the track design for a new diamond interlocking located between St. Louis Metro's existing East Riverfront light-rail station and the Eads Bridge spanning the Mississippi River.

David Borger, PE, Technical Advisor

Education: M.S., Civil Engineering, New Jersey Institute of Technology
B.S., Civil Engineering, Newark College of Engineering

Professional License/ Certification: Registered Professional Civil Engineer, NJ # 24GE02673700
Professional Planner (PP), NJ# 33LI00402800

David has more than 40 years of experience in the supervision of complex systems and facility design including trackwork, communications, traction power, and signals.

NJ TRANSIT, Hudson-Bergen Light Rail Transit DBOM, Hudson and Bergen Counties, New Jersey, Systems Design Manager. David managed the industrial engineering design for the 10-mile-long initial operating segment of this \$1 billion, 20-mile light rail system.

Metro Pasadena, Metro Blue Line (Gold Line) Light Rail, Los Angeles to East Pasadena, California, Principal-in-Charge. David held overall responsibility for the construction management of this light rail system. He was responsible for performing design and constructability reviews, resident engineering and inspection, QA/QC, systemwide and facilities engineering support, and systems integration.

RCTC, Perris Valley Line, Riverside to Perris, California, Principal-in-Charge. David is responsible for executive oversight of planning, design, and construction services for the 24-mile Riverside County Transportation Commission (RCTC) extension of the Metrolink commuter rail system.

SMART, Initial Operating Segment Design-Build, San Rafael to San Rose, California, Principal-in-Charge. David is providing executive oversight of design services for all civil, track, and structural improvements for the initial operating segment of Sonoma-Marín Area Rail Transit District (SMART) implementation of passenger rail service along the Northwestern Pacific Railroad corridor.

Martin Boyle, Technical Advisor

Education: A.S., Business Administration, Fisher College

Martin, the MBTA's former Superintendent of Transmission and Distribution, has 50 years of experience managing the design, construction, and maintenance of electrified transit systems and vehicles.

City of Ottawa, Confederation Line LRT, Ottawa, Canada, Senior Advisor. Martin is serving as Senior Advisor responsible for providing supervisory support for development of preliminary engineering necessary for the transition of Ottawa's exclusive, fully built-out bus rapid transit system to an LRT network.

CATS, LYNX Blue Line Extension, Charlotte, North Carolina, Principal-in-Charge. As Principal-in-Charge, Martin has overall responsibility for transportation planning, environmental investigations and documentation, and preliminary engineering services to 65% design for a 9.3-mile extension of the Charlotte Area Transit System (CATS) Blue Line.

MBTA, Boston, Massachusetts, Former Superintendent of Transmission and Distribution. Martin directed and coordinated all operating activities for the Transmission and Distribution Division. He was responsible for the maintenance of 100 miles of catenary, 13 miles of trolley bus, 1,300 miles of DC cable, and 300 miles of AC cable.

Karen Breslawski, AIA, Stations Design Discipline Lead

Education: M.S., Architecture, State University of New York, Buffalo
B.A., Professional Studies in Architecture, State University of New York, Buffalo

Professional License/Certification: Registered Architect, Massachusetts
National Council of Architectural Registration Boards

Karen is a Senior Architect with more than 30 years of experience in the planning, design, and development of transportation facilities for public agencies throughout Massachusetts.

NB Development Group, Boston Landing Station, Brighton, Massachusetts, Senior Architect. Karen oversaw the development of final architectural plans and provided construction administration for the new \$26 million commuter rail station located adjacent to the New Balance headquarters in Brighton.

MassDOT, Longfellow Bridge Rehabilitation Design Build, Boston and Cambridge, Massachusetts, Architect. Karen was responsible for providing technical support for architectural aspects of the rehabilitation of the Longfellow Bridge. Karen led the review of the architectural design drawings and performed QC checking for the architectural portions of the project.

MBTA, Wellington Carhouse Expansion and Improvements, Medford, Massachusetts, Project Manager. Karen was responsible for coordinating a team of architects and engineers that developed final plans for a 12,000-sf single-bay addition to the east side of the 40-year-old building. Karen provided bid-phase support and assisted the MBTA with selecting a general contractor.

MBTA, Hingham Intermodal Center, Hingham, Massachusetts, Technical Advisor. Karen conducted QA/QC reviews for the design of the intermodal transportation facility to determine whether it met applicable codes, including ADA and Massachusetts Architectural Access Board standards.

MassDOT, Central Artery DO11A, Boston, Massachusetts, Project Manager. Karen oversaw the structural, civil, mechanical, and electrical elements along with the architectural pieces of the tunnel finishes for this portion of the Central Artery/Tunnel Project.

**Robert Connors, PE, CQM/OE, CQA, CCS, CCP NETTCP QAT,
Design Quality Assurance/Quality Control Manager**

Education: M.S., Finance; Suffolk University
M.S., Business Administration, Suffolk University
B.S., Civil Engineering; University of Rhode Island

**Professional License/
Certification:** Professional Engineer, MA Civil #39185
Professional Engineer, MA Structural #38924
Certified Manager of Quality/Organizational Excellence, ASQ #13209
Certified Quality Auditor, ASQ #41100
Certified Quality Assurance Technologist, NETTCP

Robert is a Senior Quality Manager with more than 30 years of experience in engineering and project oversight for clients including the MBTA and MassDOT.

MassDOT, Longfellow Bridge Rehabilitation Design Build, Boston and Cambridge, Massachusetts, Quality Administrator. Robert is directing the QC team in the preparation and administration of the design and construction quality plans for the design build rehabilitation of the Longfellow Bridge. Robert prepared quality management plans, trained project personnel on the plans, implemented the plans, audited performance, and implemented quality improvements for design and construction.

City of Ottawa, Confederation Line LRT, Ottawa, Ontario, Canada, Quality Control/Procurement Manager. Robert performed QC and prepared bridging documents as part of the procurement team for this \$2.1 billion public-private partnership. Robert reviewed all components of the proposed project, including 13 stations, four of which are in a tunnel under downtown Ottawa between Bronson Avenue and the University of Ottawa.

WRTA, Bus Maintenance, Operations, and Storage Facility, Worcester, Massachusetts, QC Manager. Robert prepared the quality plan, trained to the plan, managed quality audits, and provided QC oversight for the design of a new vehicle maintenance, operations, and storage facility for the Worcester Regional Transit Authority (WRTA).

Metropolitan Washington Airport Authority, Dulles Corridor Metro Rail Phase 2 Project, Fairfax County, Virginia, External Quality Auditor. Robert performed FTA based quality auditing and related quality work for the Dulles Metrorail Project Management Procedures.

LIRR/MTA, East Side Access, New York, New York, External Quality Auditor. Robert performed quality auditing and related quality work for an FTA based audit of the General Engineering Consultant for this \$10.8 billion project.

Neal Depasquale, VMF Design Discipline Lead

Education: B.S., Architectural Engineering; Wentworth College of Technology

**Professional License/
Certification:** Massachusetts Certified Public Purchasing Official (MCPPO)

Neal is a Senior Project Manager with more than 35 years of experience supervising the study, design, and construction of various transportation and industrial projects for clients including the MBTA and MassDOT.

Amtrak, ARRA CM Services Southampton Yard, Boston, Massachusetts, On-Site Quality Control Engineer/Closeout Documentation. Neal provided QC services for \$22 million in rail yard and maintenance facility improvements for this design build project at Southampton Yard. Neal's role included daily inspections of the work to ensure that the work adhered to safety requirements and design documents, specifications, and approved shop drawings.

Amtrak, Northeast Corridor Acela High-Speed Rail Maintenance Facilities Design-Build, Boston, Massachusetts and Queens, New York, Assistant Project Manager. Neal was responsible for overseeing the civil/site and utility design at the Southampton Yard in Boston and Sunnyside Yard in Queens.

WRTA, Vehicle Maintenance, Operations, and Storage Facility, Worcester, Massachusetts, Project Manager. Neal oversaw design services for a new, \$75 million vehicle maintenance, operations, and storage facility for the Worcester Regional Transit Authority (WRTA).

MBTA, Green Line Copley Station Accessibility Improvements, Boston, Massachusetts, Project Manager. Neal oversaw the design and administrative duties for \$20 million accessibility improvements and general renovation of historic underground Copley Station. Neal worked closely with these agencies to develop elaborate construction zones and traffic management plans in coordination with city officials and abutters.

Ennio Eleuteri, PE, Retaining Walls Design Discipline Lead

Education: M.S., Civil Engineering, Northeastern University
B.S., Civil Engineering, Northeastern University

**Professional License/
Certification:** Professional Structural Engineer:
MA, # EN41284-ST

Ennio is a structural engineer with more than 20 years of experience in design of various structural elements of roadways, bridges, and transit facilities for clients including the MBTA and MassDOT.

MBTA, Greenbush Line Rail Restoration Design-Build, Boston, Massachusetts, Lead Structures Engineer. Ennio performed and reviewed superstructure and substructure design calculations for 10 railroad and 8 highway bridge rehabilitations. He assessed six prestressed concrete box beam bridges, designed or reviewed designs for substructure abutments, and performed construction phase services for the construction of steel and concrete bridges.

NB Development Group, Boston Landing Station, Boston, Massachusetts, QA/QC Reviewer. Ennio conducted a QA/QC review of structural designs for this new MBTA commuter rail station under construction adjacent to the New Balance corporate headquarters.

MassDOT, Belden Bly Bridge, Lynn and Saugus, Massachusetts, Project Manager. Ennio is overseeing the replacement of the Belden Bly Bridge. He has also served as the point of contact for MassDOT's project manager for all technical and contractual issues.

MassDOT, Fore River Bridge Replacement, Quincy and Weymouth, Massachusetts, Lead Structural Engineer. Ennio is providing construction-phase support for a new \$245 million vertical lift bridge. Ennio coordinated architectural, mechanical, and electrical disciplines and reviewed the final design developed by the design-build team.

South Shore Tri-Town Development Corporation, East-West Parkway Design-Build, Abington, Weymouth, and Rockland, Massachusetts, Senior Structural Engineer. Ennio performed design

reviews of bridges and retaining walls built along the eastern portion of the East-West Parkway. He also verified that the designs met contract requirements, MassDOT Bridge Manual standards, and AASHTO criteria.

J. Mark Ennis, PE, PMP, Deputy Design Manager Stations, Infrastructure, ROW

Education: M.S., Civil Engineering; Old Dominion University
B.S., Civil Engineering; University College of Dublin

**Professional License/
Certification:** Registered Professional Civil Engineer, Massachusetts

Mark has more than 25 years of varied experience involving new and rehabilitated bridge design, bridge confirmatory inspection and capacity ratings, retaining walls, and building design.

MBTA, Greenbush Line Rail Restoration Design Build, Braintree, Weymouth, Hingham, Cohasset, and Scituate, Massachusetts, Deputy Project Manager/Technical Coordinator. Mark oversaw the layout and design of 7 rail stations, 18 rail and highway bridges, 28 grade crossings, roadway intersections, 18 miles of track, and 2 railroad underpasses for the design-build project.

MassDOT, Longfellow Bridge Rehabilitation Design Build, Boston and Cambridge, Massachusetts, Design Lead. Mark provided design oversight and obtained design approval from regulatory and public agencies, including MassDOT, FHWA, MBTA, Massachusetts Department of Conservation and Recreation, U.S. Coast Guard, the City of Boston, the City of Cambridge, MassDEP, and the Historic Review Board (Section 106).

MassDOT, Fore River Bridge Replacement, Quincy and Weymouth, Massachusetts, Project Manager. Mark managed the preparation of estimates, type study reports, and sketch plans, as well as environmental permitting. He also oversaw construction support services.

Brian Flaherty, Technical Advisor

Education: Coursework, Civil Engineering, Hofstra University

Brian, STV's Design Build National Practice Leader, has more than 40 years of experience in the engineering and construction industry.

MBTA, Greenbush Line Rail Restoration Design Build, Braintree, Weymouth, Hingham, Cohasset, and Scituate, Massachusetts, Constructibility Coordinator. Brian served as Constructibility Coordinator responsible for coordinating all design efforts and developing constructibility reports for the 18-mile railroad rehabilitation project.

MassDOT, Longfellow Bridge Rehabilitation Design Build, Boston and Cambridge, Massachusetts, Constructibility Coordinator. Brian is serving as Constructibility Coordinator responsible for coordinating all design efforts and developing constructibility reports.

MTA, Capital Construction/LIRR East Side Access, Queens, New York, Constructibility Coordinator. Brian is serving as Constructibility Coordinator responsible for coordinating all design efforts and preparing constructibility reports for this \$10 billion project.

NJ TRANSIT, Meadowlands Maintenance Complex, Kearny, New Jersey, Project Director. Brian directed the construction management of this major rail vehicle maintenance facility and yard. He was responsible for establishing the project procedures manuals, a QA/QC program, the project schedule, and a work breakdown structure to administer the budget for the duration of the project.

Michael Healey, LCS, NETTCP QAT, Project Controls Manager

Education: B.S., Administration, University of Massachusetts at Amherst
Professional License/ Certification: Licensed Construction Supervisor (LCS), Massachusetts # CS- 063675
Certified Quality Assurance Technologist, NETTCP Massachusetts Certified Public Purchasing Official (MCPPO)

Michael is a project controls expert and licensed construction supervisor with 38 years of experience providing contractor oversight, document control, requests for information responses, change-order management, and QA/QC to the MBTA.

MBTA, Greenbush Line Rail Restoration Design-Build, Braintree, Weymouth, Hingham, Cohasset, and Scituate, Massachusetts, Director of Project Controls and QA/QC. Michael was responsible for all document control functions related to the submittal of more than 100 individual design packages, from preliminary to final design.

MassDOT, Longfellow Bridge Rehabilitation Design-Build, Boston and Cambridge, Massachusetts, Project Controls Manager/Assistant QC Manager. Michael tracked change orders and reviewed civil, structural, and traffic control designs for the project. Michael tracked all project documentation, including cost and schedule records.

MBTA, Green Line Copley Station Accessibility Improvements, Boston, Massachusetts, Deputy Project Manager. Michael oversaw the day-to-day design and administrative duties for this project.

MBTA, Commuter Rail Maintenance Facility, Somerville, Massachusetts, Inspector. Michael conducted construction phase service site visits for coordination of disciplines.

Amtrak, ARRA CM Services Southampton Yard, Boston, Massachusetts, Senior Resident Engineer. Michael reviewed design-build submissions and performed QC inspection of all contractors' work to verify compliance with the approved plans and specifications.

Jerome Mackenzie, PE, Structures Design Discipline Lead

Education: B.S., Civil Engineering, Northeastern University
Professional License/ Certification: Professional Structural Engineer: MA #34740-ST

Jerome has more than 30 years of experience as a structural engineer, possessing a strong management background for the design of fixed and movable bridge rehabilitation and replacement projects for clients including the MBTA and MassDOT.

MBTA, Greenbush Line Rail Restoration Design-Build, Braintree, Weymouth, Hingham, Cohasset, and Scituate, Massachusetts, Senior Structural Engineer. Jerome reviewed the structural design for several rail bridges on this project.

MassDOT, Longfellow Bridge Rehabilitation Design-Build, Boston and Cambridge, Massachusetts, Lead Structural Design Engineer. Jerome oversaw teams of designers focused on the superstructure elements.

DART, LRT Extensions Phase I & Phase II, Dallas, Texas, Lead Bridge Engineer. Jerome oversaw preliminary through final design for three light rail and three heavy rail bridges for the project.

Metro-North, PECK Drawbridge and Bridgeport Railroad Viaduct Rehabilitation, Bridgeport, Connecticut, Structural Design Engineer/Inspector. Jerome performed a bridge inspection for the rehabilitation of the PECK Railroad Bridge.

MassDOT, University Avenue Bridge Improvements, Lowell, Massachusetts, Project Manager. Jerome managed the design and construction phases for the replacement of this historic steel deck truss bridge over the Merrimack River.

Christopher R. McDermott, PE, LSP, Environmental Manager

Education: B.S., Engineering Sciences, Washington University, St. Louis, MO
B.S., Applied Math and Physics, Providence College

Professional License/ Licensed Site Professional, MA # 1955

Certification: Professional Engineer, MA # 48272

Christopher has more than 20 years of experience providing environmental engineering and Licensed Site Professional (LSP) services to large infrastructure and transportation projects in Massachusetts.

MassDOT, Longfellow Bridge Rehabilitation Design-Build, Boston and Cambridge, Massachusetts, LSP. Christopher managed the characterization of contaminated soil and all hazardous materials on the bridge, the MBTA Red Line right-of-way, the piers, towers and abutments, the Storrow Drive pedestrian walkway, and associated subsurface soil in the area.

WRTA, Vehicle Maintenance, Operations, and Storage Facility, Worcester, Massachusetts, LSP. Christopher directed extensive pre-construction characterization, developed plans, specifications, and cost estimates for soil remediation and a vapor barrier for the Worcester Regional Transit Authority (WRTA)'s new vehicle maintenance facility.

Bosfuel Corporation, MCP Compliance and Environmental Management during Pipeline Construction at Logan Airport, Boston, Massachusetts, LSP-of-Record/Project Manager. Christopher provided environmental investigation, remediation design, construction oversight and MCP compliance in support of Bosfuel's replacement of a portion of Logan's Fuel Delivery System (FDS).

MBTA, On-Call Environmental Services Contract, Boston, Massachusetts, Project Manager/LSP. Christopher provided environmental engineering and LSP services on several task orders, including the Durante Wetlands Mitigation remedial cost estimation and evaluation of groundwater remediation at Cabot Yard.

MBTA, Wellington Carhouse Expansion and Improvements, Medford, Massachusetts, LSP/Senior Engineer. Christopher performed the assessment of contaminated soil and hazardous building materials during the carhouse renovation.

MBTA, 12 Bridges Replacement Project, Boston, Massachusetts, Senior Engineer/LSP. Christopher directed the due diligence hazardous materials assessment of multiple bridges, as well as the evaluation of hazardous materials, including asbestos and lead-based paint, in existing bridge structures.

Thomas O'Hara, Deputy Design Manager Operations, Systems, and VMF

Education: Coursework, Business Management; Quincy Junior College
Professional License/ Certification: Journeyman Electrician, Massachusetts
Right-of-Way Training, Massachusetts Bay Transportation Authority

Thomas is an expert in transit operations and rail power systems who led the MBTA's Power Division for almost eight years. He has 34 years of experience in commissioning of new traction power substations, installation of OCS for the Silver Line, the AC cable replacement program, SCADA systems, and mobile substations, and is intimately familiar with MBTA operations, having directed and supervised the maintenance of local power systems, equipment, and transmission and distribution areas.

MBTA, Wellington Carhouse Expansion and Improvements, Medford, Massachusetts, Traction Power Specialist. Thomas coordinated with multiple disciplines to design the stinger trolley system for the expansion and renovation of the 120,000-sf Wellington Carhouse maintenance facility.

MassDOT, Longfellow Bridge Rehabilitation Design Build, Boston and Cambridge, Massachusetts, Systems Lead. Thomas coordinated with all the different disciplines to design the rail systems for MassDOT's rehabilitation of the Project. Thomas has also introduced a vital serial link for the signal system, which the MBTA approved.

MBTA, Orange Line Traction Power Upgrades, Boston, Massachusetts, Project Manager. Thomas has provided design, QA/QC, scheduling, and budget services for the project.

HMLP, Stray Current Testing and Evaluation, Boston, Massachusetts, Project Manager. Thomas oversaw the monitoring and evaluation of stray current within an area of the MBTA's Greenbush Line on behalf of Hingham Municipal Light & Power (HMLP).

MBTA, Operations Support GEC, Massachusetts, Project Manager. Thomas managed an on-call team of professional consultants that assisted with the maintenance of tracks, stations, vehicles, and maintenance facilities.

Robert J. Palermo, PE, Geotechnical Design Discipline Lead

Education: B.S., Civil Engineering, Northeastern University
M.S. Studies, Massachusetts Institute of Technology
Professional License/ Certification: Professional Engineer, MA No. 32053

Robert has more than 40 years of experience in all aspects of geotechnical engineering and underground construction on bridge and transit projects in the U.S. and Canada, including: soil and rock mechanics, shallow and deep foundation engineering, seismic design, underpinning, instrumentation and monitoring, ground improvement, construction dewatering, and lateral support systems.

NY State Freeway Authority, Tappan Zee Hudson River Crossing Design-Build, Tarrytown/South Nyack, New York, Lead Geotechnical Engineer. Robert was responsible for the foundation design performed during the Tender Design phase, as well as the subsurface explorations, pile load testing program, and engineering analyses performed during the final design phase.

MassDOT/MBTA, Multiple Bridges, Various Locations, Massachusetts, Lead Geotechnical Engineer/Senior Technical Reviewer. Robert has served as the Lead Geotechnical Engineer/Senior Technical Reviewer on more than 100 replacement or rehabilitation bridge projects, some of which included use of accelerated bridge construction methods.

Amtrak, Hartford Line, Various locations, Connecticut and Massachusetts, Lead Geotechnical Engineer. Robert was responsible for the redesign of more than 8,000 lf of retaining wall to support Cooper E80 train loads as value engineering for the contractor, Middlesex Corporation. The redesign resulted in significant schedule and cost savings to the owner and the contractor.

MBTA/Delaware North, TD Garden, Boston, Massachusetts, Lead Geotechnical Engineer. Robert designed rock socketed caissons, load bearing elements, and lateral support walls for a new facility with 5 levels of below grade parking.

Mark W. Pelletier, PE, Design Manager

See Proposal Part 5 – Key Personnel and Experience Qualitative Evaluation Criteria for resume.

Eric Root, PE, Systems Design Discipline Lead

Education: B.S., Electrical Engineering; Virginia Polytechnic Institute and State University

Professional License/Certification: Professional Engineer, VT Electrical #018.0107605

Eric is an electrical engineer with more than 27 years of experience involving transportation, utility, and power generation projects. His expertise includes systems project management, electric power systems, system start-up, interfaces for light rail transit and commuter systems, and controller design for clients including MassDOT.

City of Ottawa, Confederation Line LRT, Ottawa, Ontario, Canada, Traction Power Engineer.

Eric completed the initial traction power design and analysis for the project to transform an exclusive, fully built-out bus rapid transit system into a light rail transit network – the first such conversion in North America.

Region of Waterloo, Rapid Transit Division ION LRT System, Ontario, Canada, Systems Manager. Eric is providing engineering services for the ION LRT system for the Region of Waterloo Rapid Transit Division. The 11.8-mile (19-km) network will operate 14 light rail vehicles across 22 stations.

MassDOT, Longfellow Bridge Rehabilitation Design Build, Boston and Cambridge, Massachusetts, Traction Power Engineer. Eric was responsible for both train control and traction power for this design build rehabilitation project

Metro East, San Fernando Valley Transit Corridor, Los Angeles, California, Systems/Traction Power Design Lead. Eric led rail systems and traction power design for proposed improvements to transit service and regional connections through the heart of Los Angeles's San Fernando Valley along Van Nuys Boulevard and San Fernando Road.

CATS, LYNX Blue Line Extension Light Rail Project, Charlotte, North Carolina, Systems Manager/Traction Power Engineer. Eric was responsible for performing systems management for preliminary and final engineering services for the 9.3-mile Blue Line Extension for the Charlotte Area Transit System (CATS).

He was responsible for the sizing and location of traction power substations, and developed traction power technical reports and design criteria.

MassDOT, Red/Blue Line Connector, Boston, Massachusetts, Lead Systems Engineer. Eric performed load flow simulation for a proposed MassDOT project to extend the MBTA Blue Line 1,500 feet on the Bowdoin end while eliminating the existing Bowdoin Station and adding a new Charles/MGH Station. Eric's simulation also included installation of a new traction power substation and removal of an existing feeder from North Substation. The load flow simulation verified that the design met the operation criteria of 6-car trains running at 4-minute headways at crush load.

Paul Tyrell, PE, PLS, LEED AP BD+C, Road & Right-of-Way/Grading Design Discipline Lead

Education:	B.S., Civil Engineering; Wentworth Institute of Technology
Professional License/ Certification:	Registered Professional Civil Engineer, Massachusetts Professional Land Surveyor, Massachusetts LEED Accredited Professional

Paul is an accomplished professional engineer and land surveyor with 31 years of technical expertise in boundary and subdivision control law, easements and property rights issues, environmental permitting, hydraulics and hydrology, and trenchless technologies.

MBTA, Greenbush Line Rail Restoration Design-Build, Braintree, Weymouth, Hingham, Cohasset, and Scituate, Massachusetts, Senior Civil Engineer. Paul designed all required project utilities and utility relocations for the 18-mile-long reconstruction of the out-of-service railroad ROW. Paul oversaw preparation of more than 130 design packages with multiple submissions. He managed all utility design; was responsible for inventory, evaluation, relocation, and protection of more than 250 different utilities along the proposed alignment; and coordinated with the design-build contractor and numerous public and private agencies.

MassDOT, Longfellow Bridge Rehabilitation Design-Build, Boston and Cambridge, Massachusetts, Deputy Project Manager. Paul is responsible for coordinating design and construction for the design-build rehabilitation of the Longfellow Bridge. During the design phase, Paul coordinated design efforts for the entire design team including numerous subconsultants. He managed document control, design schedule, project submissions, and monitored QA/QC and permit compliance.

MBTA, Wellington Carhouse Expansion and Improvements, Medford, Massachusetts, Civil QA/QC Reviewer. Paul conducted a quality review and endorsed the final design submission for all civil components of the planned expansion and renovation of the Wellington Carhouse. Paul reviewed final designs and specifications for track alignment modifications within the carhouse and yard.

Amtrak, ARRA CM Services Southampton Yard, Boston, Massachusetts, Owner's Representative. Paul provided design review services for improvements to the Southampton Rail Yard. Paul provided construction management (CM) services, including review of all design-build submissions and QC inspections of all contractors' works to verify compliance with the approved plans and specifications.

Proposed Construction Organization

Our well-seasoned construction execution team has worked together extensively on past projects. Communication and integration are crucial for successful execution. In preparing for the Green Line Extension DB Project, we have revisited our previously established coordination plans for projects that are similar in size, complexity, and nature, and we have customized our plans to be Project-specific. Derived from multiple best practice construction management plans from our respective corporations, the MBTA can have full confidence that GLX Constructors has a solid construction approach that is fully tailored to achieve the MBTA's Project goals, cost, and schedule objectives.

Figure 3.1-2 illustrates the required relationships among the Construction Team. Our Construction Organization will be 100 percent dedicated to the Green Line Extension DB Project during the time in which their respective construction phases are ongoing. Our key personnel have been 100 percent dedicated to the Project since the Proposal Phase, and they will continue to be completely dedicated until completion of their scope of work.

Our Construction Team will be fully committed to the efficient execution and collaboration with the MBTA and Project stakeholders to mitigate risks, respond quickly to issues as they arise, and achieve the MBTA's goals to deliver the Project in a cost-effective, timely manner.

John West will lead GLX Constructors' Construction Team. Jamie Doyle, Aaron Neeley, Michael Hoitink, Sam Choy, and Robert Horn will support John and lead individual Construction Project Engineers and Superintendents managing the following disciplines:

- ▶ Stations
- ▶ Utilities
- ▶ Road and ROW/grading
- ▶ Systems
- ▶ Track
- ▶ Vehicle Maintenance Facility (VMF)
- ▶ Structures
- ▶ Retaining walls
- ▶ Environmental
- ▶ Geotechnical

We will mobilize these same construction discipline Project Engineers and Superintendents during the Design Phase of the Project to begin developing work plans and providing schedule input, engaging with third parties, performing constructability reviews, and refining the budget as the design progresses.

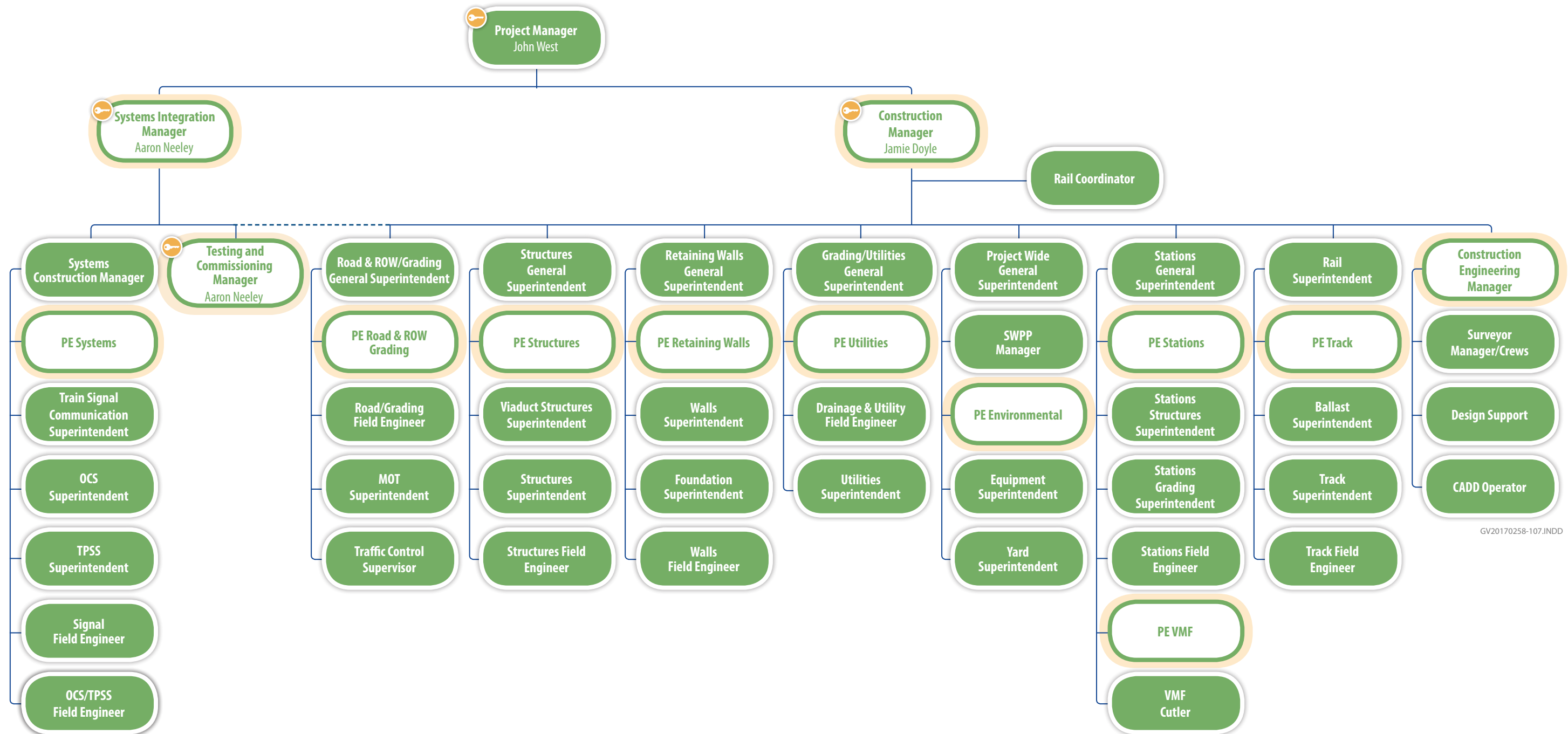

GV20170258-107.INDD

Figure 3.1-2. Proposed Construction Execution Organization. Our Proposed Construction Execution Organization chart illustrates our proposed construction organization, indicating the responsibilities and structure of the construction staff, down to and including field superintendents and the staff positions proposed under each field superintendent for all shifts, and including systems integration and testing and commissioning functions.

Proposed Project Organization

The firms that comprise GLX Constructors closely possess the skills and resources necessary to make the Green Line Extension DB Project a success, including extensive DB experience, applicable technical and construction expertise, and long-term working relationships with the MBTA and local major stakeholders. Using a fully integrated joint venture model and a best-person-for-the-job approach, we have carefully selected our project Personnel from our combined pool of resources.

Figure 3.1-3 represents GLX Constructors' integrated Project Organization chart, which illustrates how the Design Team and Construction Team will work together over the duration of the Project. Together they will provide a successful handoff for Testing and Commissioning and Closeout Phases.

Our Project Executive, Clyde Joseph, and Project Manager, John West, will lead the overall Project Management efforts through the Design and Construction Phases of the Project and through full Testing and Commissioning. Clyde and John will be jointly responsible for integrating the Safety, Quality, Design, Construction, and Business Teams to form a single, cohesive DB Management Team and will report directly to the MBTA Program Manager, John Dalton, for Contract Execution and to the JV Executive Committee for internal management decisions.

To provide an efficient and cost-effective DB Management Team organization, we engage Project Directors and their respective primary leaders at the onset of the Proposal Phase and throughout the Project Execution Phase. At the start of the Project Execution Phase, our DB Management Team will publish a refined and compliant Project Management Plan; Quality Management Plan (including a Design Quality Management Plan); Safety, Security, and Emergency Management Plan; and the project HSE Plan.

The DB Coordinator, Design Manager, and multiple Technical Design Discipline Leads manage our Design Team, completing and developing our Technical Solutions, in accordance with the Technical Provisions. Concurrently with the Design Team's efforts, the Construction Manager will mobilize our Construction Team, including the construction discipline Project Engineers and Superintendents. This critical group of Construction Team Lead personnel will directly integrate with the Design Discipline Leads and our TWGs.

Our Business Services Team will manage the construction scheduling, cost, document control, procurement, and finance functions of the Project.

Construction Discipline
Project Engineers and
Superintendents from our
Construction Team will
work directly with
the Design Discipline
Leads in our TWGs to
seamlessly integrate
the Project's Design and
Construction Phases.

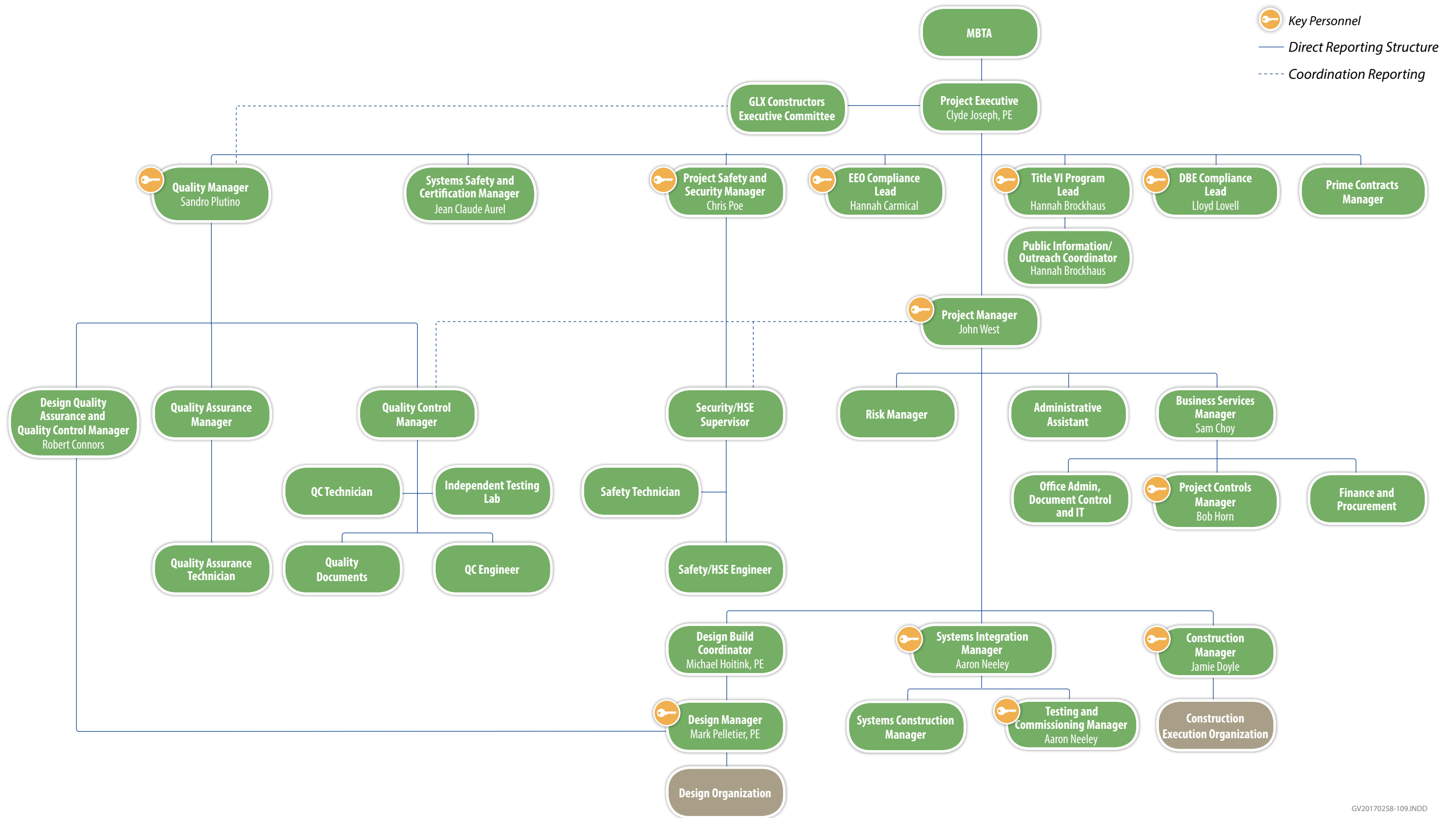

GV20170258-109.INDD

Figure 3.1-3. Proposed Project Management Organization. Our Proposed Project Management Organization chart illustrates how the Design Organization and Construction Organization will work together over the duration of the Project.

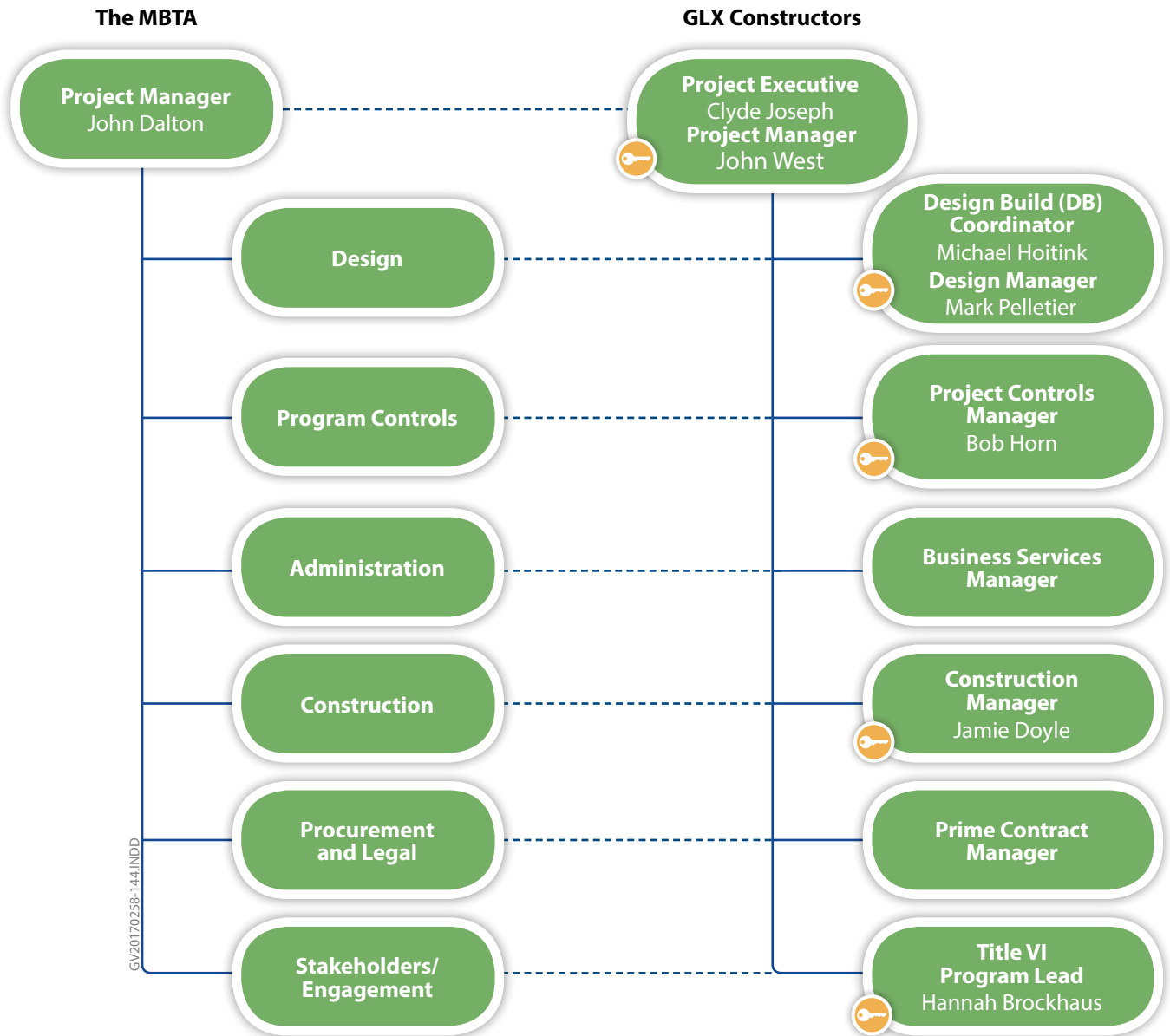

Figure 3.1-4. Interfaces between the MBTA and GLX Constructors. *GLX Constructors’ collaborative approach to Project execution with the MBTA will facilitate direct lines of communication and transparency to get the job done right the first time.*

Important direct interfaces between GLX Constructors’ team members with the MBTA’s key team members are illustrated in Figure 3.1-4.

We have assembled GLX Constructors to provide transparent, effective, and efficient Project Management collaboratively with the MBTA and third-party stakeholders. Our Key Personnel are fully dedicated and committed to executing the Project, providing schedule and cost certainty for the MBTA.

3.1.B DESIGN MANAGEMENT CONCEPT

GLX Constructors' Lead Designer, STV, brings local and national expertise in DB project delivery, including the successful completion of some of the most complex, large-scale transportation projects in Massachusetts and across the United States.

STV has designated experienced and capable personnel to the Project. As residents of Boston, STV understands this Project is one of the most desired and needed transportation projects in the Commonwealth, and the allocation of their most highly qualified personnel to the GLX Constructors team is a direct reflection of this understanding. Through our commitment to providing excellent design staff to the MBTA, STV and GLX Constructors' design concept will provide the MBTA with the resources necessary to efficiently complete the Project from design through safety certifications, revenue operations, and closeout.

Mark Pelletier, PE
Design Manager

Michael Hoitink
Design Build Coordinator

Structure of GLX Constructors' Design Organization

Our DB Coordinator, Michael Hoitink, and Design Manager, Mark Pelletier, PE, will provide overall Design Project leadership during the Design Phase. Michael reports directly to Project Manager, John West, and he has the primary responsibility for fully integrating the design into construction. Our Design Manager, Mark, is responsible for delivering the fully approved design. Mark has an extensive record of successfully completing significant transit DB projects in Massachusetts and a long history of excellent work performed for the MBTA.

Mark Ennis
Deputy Design Manager
Stations, Infrastructure, and ROW

Thomas O'Hara
Deputy Design Manager
*Operations, Systems, and Vehicle
Maintenance Facility (VMF)*

As our Design Manager on the Green Line Extension DB Project, Mark will:

- ▶ Provide direction to the Design Team and its subconsultants
- ▶ Interface with the MBTA and MassDOT through our DB Coordinator
- ▶ Collaborate with regulatory agencies that hold jurisdiction over the Project

Because of the magnitude and influence of the Green Line Extension DB Project, STV has assigned two Deputy Design Managers, Mark Ennis, PE, PMP, and Thomas O’Hara to our team to support the Project.

In our organization, the Deputy Design Managers will report directly to Mark Pelletier, our Design Manager leading the advancement of the Project. To this end, all deliverables will be consistently prepared with the program requirements, focused on meeting schedule, cost, and Contract requirements.

Design Discipline Leads

The next level of the design organization comprises the Design Discipline Leads. These leads facilitate the Project’s overall technical design coordination effort. We have divided the Project into 10 major categories with their identified Design Discipline Leads.

Category	Design Discipline Lead
Stations	Karen Breslawski, AIA
Utilities	Sean Barry, PE
Road and ROW/grading	Paul Tyrell, PE, PLS, LEED
Systems	Eric Root, PE
Track	Paul Bobby, PE
VMF	Neal DePasquale
Structures	Jerome MacKenzie, PE
Retaining walls	Ennio Eleuteri, PE
Environmental	Chris McDermott, PE, LSP
Geotechnical	Robert Palermo, PE

Technical Working Groups (TWGs)

The TWGs will be composed of the Design Discipline Lead, Construction Discipline Project Engineers and Superintendents, the MBTA’s discipline Technical Reviewers, and the appropriate third-party stakeholders as shown in Figure 3.1-5. The 10 TWGs will interact both formally through regularly scheduled meetings, and informally on a daily basis at the co-located office. For more information about the benefits of our co-located office, see Section 3.1.B.3.

By embedding the Construction Team, the MBTA, and third-party stakeholders into the TWGs, we advance our design and Technical Solutions in a cohesive manner, and we immediately address any potential issues surrounding constructability and work phasing during design development.

The Construction discipline’s Project Engineers and Superintendents will oversee the Design Packages’ transition from design into construction through the development of Construction Work Plans. To maintain

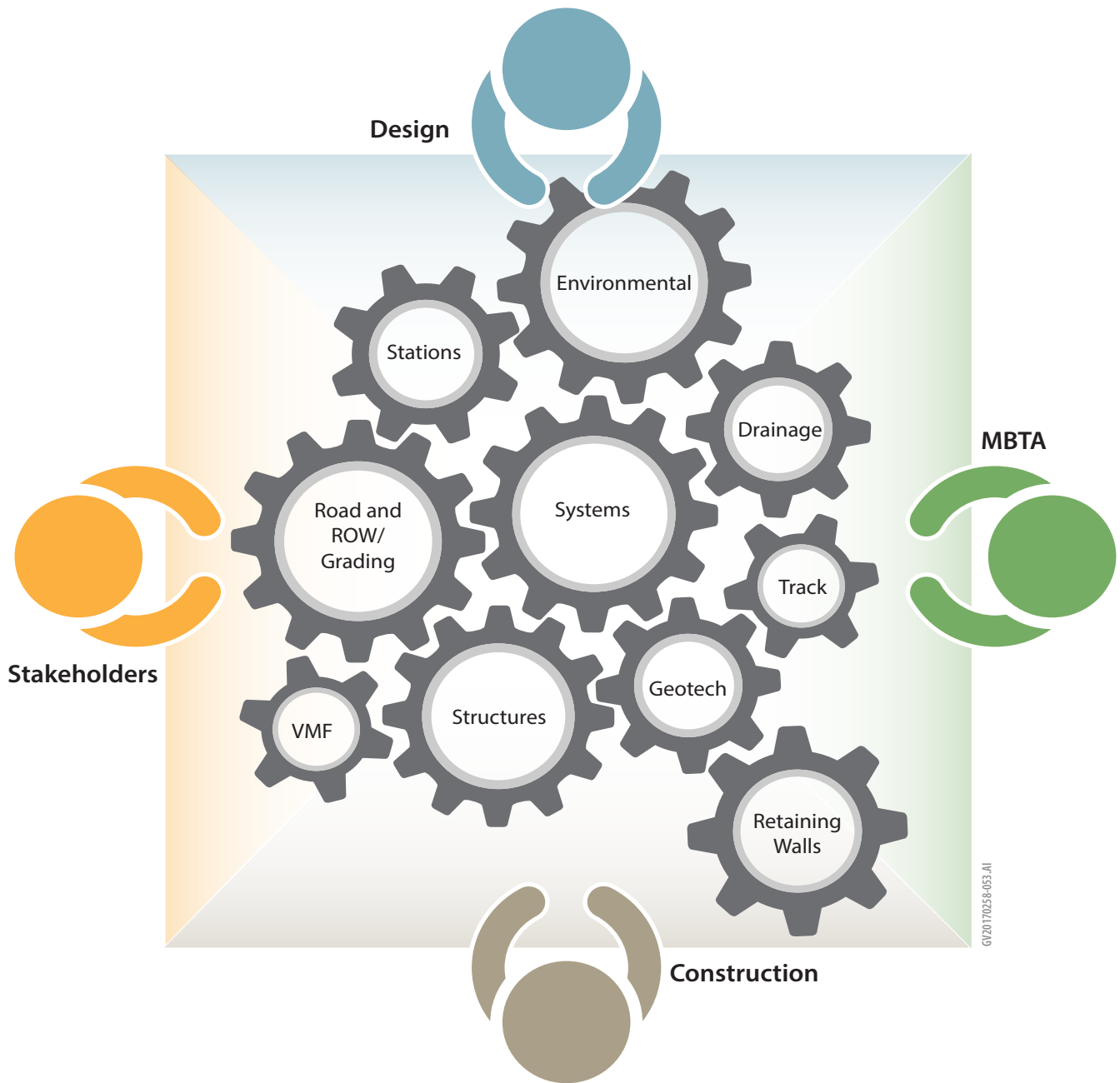

Figure 3.1-5. TWGs – a Seat at the Table. By including the MBTA and third-party stakeholders in each of our TWGs, all design elements will function together as a piece of the whole design, which will be executed to meet or exceed the MBTA’s requirements.

collaboration and unity throughout the entirety of Project execution, the TWG structure will remain in effect during the Construction Phase, but with the design team transitioning to a supporting role.

These TWGs will fulfill the MBTA’s requirements listed in Section 2.2.3.

To the Project’s benefit, GLX Constructors has consistently held TWGs since the beginning of Proposal development. During the Proposal Phase, we have established a TWG Communications Plan, which supports holistic

integration by defining how we record and distribute design decisions made within each TWG. Further, the TWG Communication Plan identifies the protocol for interactions and information sharing with other groups, which expedites the design process and improves its quality.

The Design Discipline Leads are responsible for implementing and overseeing the TWG Communications Plan, for organizing Over-the-Shoulder Reviews, Progress Reviews, and other interactions with the MBTA's Design Review Team. We will include the MBTA's discipline Lead Reviewers and appropriate third-party stakeholders in each Technical Working Group for the duration of the Design Phase and Construction Phase. During these informal reviews, we will partner with MBTA to address any potential issues or conflicts. By doing so, we will have issues resolved prior to the formal Design Package submittal.

We will conduct internal weekly Progress Meetings, scheduled ahead of the MBTA's weekly Progress Meetings. The Design Discipline Leads will meet with the Design Manager, the Deputy Design Managers, and the DB Coordinator to address the design status, coordinate the efforts between TWGs, identify any significant concerns or potential issues raised by each TWG, and provide an update for the formal Progress Meeting.

GLX Constructors will interface with the MBTA on a daily basis and with third parties as required for approvals and design completion. The Design Management Team will participate in relevant meetings identified in Volume 2, Section 2.2 of the Contract. A summary of the recurring meetings identified in Volume 2, Section 2.2 is presented in Figure 3.1-6.

Construction supports Design, which supports Construction.

Construction-driven execution embeds Construction Project Engineers within the Design Phase, then reverses and embeds Design Discipline Leads within the Construction Phase.

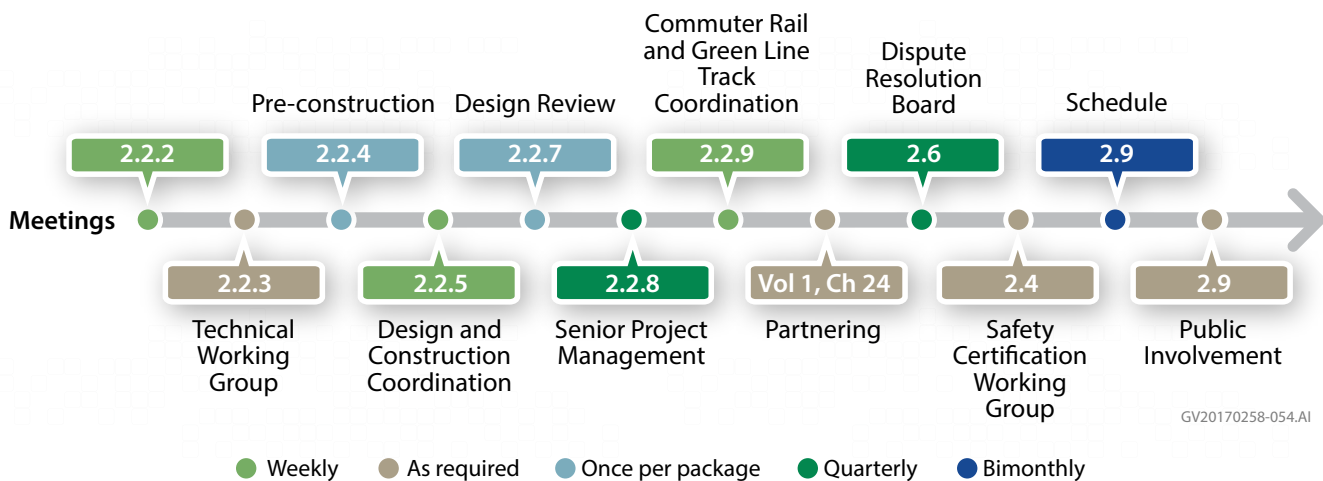

GV20170258-054.AI

Figure 3.1-6. Minimum Mandatory Project Meetings with the MBTA and Other Parties. Regularly scheduled meetings will mitigate or eliminate issues before they arise and smooth the seam between the Design and Construction Phases of the Project.

Design Packages

Figure 3.1-7 details our Design Package structure. As indicated, each Design Package will be assigned to one of the Design Discipline Leads who have the daily responsibility for design execution. It is the Design Discipline Leads' responsibility to confirm that the work is performed in accordance with both the Contract, and the Safety and Quality Management Plans.

Design Package	Technical Working Group	Discipline Design Leads (All Co-Located)	Package Manager	30% Basis of Design	60% Preliminary Design	90% Final Design	RFC Submission
Medford Street Bridge	Structures	Jerome MacKenzie	Gustavo Escoria	■		■	■
Broadway Bridge	Structures	Jerome MacKenzie	Ani Chatterjee	■		■	■
Cedar Street Bridge	Structures	Jerome MacKenzie	Michael Scott	■		■	■
College Avenue Roadway and Ped Bridges	Structures	Jerome MacKenzie	Christian D'Annunzio	■		■	■
School Street Bridge	Structures	Jerome MacKenzie	Christian D'Annunzio	■		■	■
Walnut Street Bridge	Structures	Jerome MacKenzie	Michael Scott	■		■	■
Lowell Street Bridge	Structures	Jerome MacKenzie	Gustavo Escoria	■		■	■
Magoun Square Station	Stations	Karen Breslawski	Benjamin Lassel	■	■	■	■
Gilman Square Station	Stations	Karen Breslawski	Benjamin Lassel	■	■	■	■
College Avenue Station	Stations	Karen Breslawski	Margret Weed	■	■	■	■
East Somerville Station	Stations	Karen Breslawski	Emily Talcott	■	■	■	■
Ball Square Station	Stations	Karen Breslawski	Margret Weed	■	■	■	■
Lechmere Station	Stations	Karen Breslawski	John Gonzalez	■	■	■	■
Union Square Station	Stations	Karen Breslawski	Emily Talcott	■	■	■	■
Viaduct – Pier 1 thru Pier 7 (Lechmere)	Structures	Jerome MacKenzie	William Goulet	■		■	■
Viaduct – Pier 7 thru Pier 21 (Lechmere/Medford Branch)	Structures	Jerome MacKenzie	Brian Query	■		■	■
Viaduct – Pier 21 thru Abut 37 (Medford Branch)	Structures	Jerome MacKenzie	William Goulet	■		■	■
Viaduct – Union Square Eastbound	Structures	Jerome MacKenzie	Jason Griscom	■		■	■
Viaduct – Union Square Westbound	Structures	Jerome MacKenzie	Richard Ezyk	■		■	■
Walls (1)	Retaining Walls	Ennio Eleuteri	Marian Barth	■		■	■
Walls (2)	Retaining Walls	Ennio Eleuteri	Scott Benson	■	■	■	■
Walls (3)	Retaining Walls	Ennio Eleuteri	David Machalla	■	■	■	■
Walls (4)	Retaining Walls	Ennio Eleuteri	Stephen Makris	■	■	■	■
Track Medford and Union Branches, Commuter Rail	Track	Paul Bobby	Patrick Bryant	■	■	■	■

Design Package	Technical Working Group	Discipline Design Leads (All Co-Located)	Package Manager	30% Basis of Design	60% Preliminary Design	90% Final Design	RFC Submission
Rail Yard Track	Track	Paul Bobby	David Gonsalves	■	■	■	■
Drainage (Watershed 1)	Roadway/Grading	Paul Tyrell	Preethi Sreeraj	■		■	■
Drainage (Watershed 2)	Roadway/Grading	Paul Tyrell	Preethi Sreeraj	■		■	■
Drainage (Watershed 3)	Roadway/Grading	Paul Tyrell	Gregory Wilson	■		■	■
Drainage (Watershed 4)	Roadway/Grading	Paul Tyrell	Gregory Wilson	■		■	■
Pump Stations	Roadway/Grading	Paul Tyrell	Judith O'Mara	■		■	■
Washington Street Rail Bridge	Structures	Jerome MacKenzie	Ani Chatterjee	■		■	■
Medford St and Harvard St Rail Bridges	Structures	Jerome MacKenzie	Michael Scott	■		■	■
Signals	Systems	Eric Root	James Collier	■	■	■	■
Power and OCS	Systems	Eric Root	James Candlish	■	■	■	■
Red Bridge Traction Power Sub-Station	Systems	Eric Root	Robert Ward	■	■	■	■
Ball Square Traction Power Sub-Station	Systems	Eric Root	Robert Ward	■	■	■	■
Pearl Street Traction Power Sub-Station	Systems	Eric Root	Robert Ward	■	■	■	■
Communications	Systems	Eric Root	Chris Hertz	■	■	■	■
VMF and Rail Yard – Site Preparation	VMF/Buildings	Neal DePasquale	David Gonsalves	■		■	■
Vehicle Maintenance Facility	VMF/Buildings	Neal DePasquale	Steve Packard	■	■	■	■
Transportation Building	VMF/Buildings	Neal DePasquale	Peter Di Simone	■	■	■	■
Community Path – Civil/Lighting/Communications	Roadway/Grading	Paul Tyrell	Christopher Cotter	■	■	■	■
Community Path – Structural	Structures	Jerome MacKenzie	Scott Benson	■	■	■	■
Off Site Intersections	Roadway/Grading	Paul Tyrell	Erik Maki	■	■	■	■
VMF Site Building Demolition	VMF/Buildings	Neal DePasquale	Chris McDermott	■		■	■
Gilman Square Station Site Building Demolition	VMF/Buildings	Neal DePasquale	Chris McDermott	■		■	■
Ball Square Site Building Demolition	VMF/Buildings	Neal DePasquale	Chris McDermott	■		■	■
Utility Bridges	Structures	Jerome MacKenzie	Michael Scott	■	■	■	■
Fences and Landscaping	Roadway/Grading	Paul Tyrell	Sean Barry	■	■	■	■

Figure 3.1-7. Design Package Structure. Each Design Package will be assigned to one of the Design Discipline Leads who have the daily responsibility for design execution.

Our Design Management Plan requires an inter-disciplinary review where the Design Discipline Lead presents the proposed technical solution to other design discipline Leads for review and coordination, ensuring a “holistic” design that is complementary among and across all disciplines. This inter-disciplinary review occurs prior to submission for review and approval by the MBTA. Most recently, STV successfully implemented this strategy on the Longfellow Bridge Rehabilitation Project, a project in which extensive interdependency between 40 separate Design Packages was required. GLX Constructors has included this same coordination review procedure in our Quality Management Plan.

Resources and Personnel Needed to Effectively and Efficiently Manage the Project During the Design Phase

Our Design Team utilizes resource-loaded scheduling methods to identify the number of personnel required completing each Design Package, the schedule for each, and consequently, the total number of designers needed on a weekly basis for the duration of design activities. As evidenced by our Key Personnel throughout Project Execution, illustrated in Figure 3.1-7, GLX Constructors will maintain a versatile and experienced DB Management Team that is closely familiar with the MBTA's and the FTA's procedures and practices to support the Design Team. In similar fashion, GLX Constructors will be responsible for proper document control, scope conformance, schedule adherence, and for implementing the Quality Management Plan.

Our Design Management Team – Michael Hoytink, Mark Pelletier, Mark Ennis, and Tom O'Hara – will support the Design Discipline Leads in preparing each Design Package submittal. Prior to submission, our DB Coordinator, Michael Hoytink, will be responsible for confirming that each package conforms to the Quality Management Plan and to the requirements of the Contract Volume 2, Section 2.7.4. For each Design Package, we will complete the corresponding checklist, and our final Design Package submission will conform to the Contract.

GLX Constructors and our Design Team understand that 17 items are required to be submitted for each Preliminary Design Submission (30%), 16 items are required for each Intermediate Design Submission (60%), and 14 items are required for each Pre-release for Construction Submission (90%) for the MBTA's review.

Management and Integration of Subcontractors and Suppliers

We will manage our design subconsultants as an extension of our own Design Team. This means they will be fully integrated into our Design Team, attend our TWG meetings, and work from our co-located Project Office with the MBTA. Co-location is critical to the success of this Project, as discussed in further detail below. Where utilized, suppliers will provide detailed

Personnel Resources					
Key Personnel	Name	Design Phase	Construction Phase	Testing and Commissioning Phase	Closeout Phase
Project Manager	John West	→			
Project Safety and Security Manager	Chris Poe	→			
Construction Manager	Janie Doyle	→			
Design Manager	Mark Pelletier	→			
Project Controls Manager	Robert Horn	→			
Systems Integration Manager	Aaron Neeley	→			
Quality Manager	Sandro Plution	→			
Title VI Program Lead	Hannah Brockhaus	→			
EEO Compliance Lead	Hannah Carmical	→			
DBE Compliance Lead	Lloyd Lovell	→			
Testing and Commissioning Manager	Aaron Neeley	→			

GV20170258-160.INDD

Figure 3.1-7. GLX Constructors’ Key Staffing on the Project from Design to Closeout. As it is with our Key Personnel, our staffing durations are critical to managing the Project from the Design Phase until Project Closeout.

documentation about their products so we can properly evaluate the product for compliance and inclusion within the Design Specifications and Drawings.

Our Design Team has extensive working experience with our selected subconsultants – often on alternative delivery projects with accelerated schedules. For example, during the design of the Longfellow Bridge Rehabilitation DB Project, STV worked with Chris McDermott of TRC, our GLX Environmental Design Consultant, to mitigate the unexpected discovery of contaminated soils located in the Longfellow towers. To avoid a schedule delay, it was necessary to take immediate and proactive action. In coordination with the DB Contractor, Chris worked closely with several STV staff members through the Civil and Environmental Technical Working Groups to prevent schedule slippage. To provide an added layer of benefit to the MBTA, GLX Constructors has implemented our TWG processes in the same manner they were coordinated on the Longfellow Bridge Rehabilitation DB Project.



On the MBTA's Greenbush Commuter Rail Project, the alignment included many hazardous conditions. As part of the project execution team, GLX Constructors' team member, Balfour Beatty, was part of the Joint Venture that achieved a superior safety record throughout the project, including worker safety and the potential impacts to the public. For example, Balfour Beatty was responsible for all testing and commissioning of the system working in partnership with the MBTA's Operator and FTA inspectors. This involved staged testing of each crossing, following which testing was performed on a live track using operator-provided locomotives on the four-quad crossing gate systems, which the MBTA had not previously used. The work under live track was successfully completed in accordance with Balfour Beatty's site-specific safety plan.

Where Different Elements of the Design will be Performed

GLX Constructors' Design Management Team, Design Discipline Leads, subconsultants, and necessary support staff will be co-located with GLX Constructors at the Green Line Extension DB Project Office site, designated by the MBTA, at 200 Innerbelt Road, Somerville, Massachusetts. By co-locating at the MBTA's Project Office site, we will be able to simply walk down the hallway to resolve issues or receive answers to pertinent questions. Co-location flattens the organization and produces quick results in real-time.

Our Design Team will perform the majority of the design work at the co-located Project Office, and we will supplement any remaining design work from satellite STV offices in Boston, Chicago, and Charlotte, utilizing our regional and national resources. The Design Team will manage these supplemental design resources from the co-located Project Office.

3.1.C CONSTRUCTION MANAGEMENT CONCEPT

GLX Constructors has defined our Project Management approach as "construction-driven execution." Our process involves five key actions for execution. These five actions will provide for a more efficient construction project, elevated schedule and cost certainty, and in the successful end, a satisfied Client, stakeholders, and community members. The five actions are:

1. **Engage Early and Often.** To get timely "buy in" from the Construction Team, the Design Team engages early and often with the Construction Team and the MBTA personnel that are involved in the early Design and Project Implementation Phases.
2. **Construction Advice.** Early and often through constructability reviews, interdisciplinary reviews, and recommendations for construction efficiency.

“
We plan on moving excavated materials by rail to a designated point for processing. This will take trucks off the streets along the alignment.”

3. **Ask which Cost-Effective Construction Solutions are Best for the Construction Team.** Because the majority of Project costs are associated with the physical construction and materials, our process emphasizes this phase to develop cost-effective solutions.
4. **Long-Term Solutions.** We focus on long-term goals rather than short-term deadlines.
5. **Construction Efficiency and Productivity.** We prioritize field efficiency and productivity over the needs of any one discipline or area. This is likewise driven by interdisciplinary reviews to make certain one discipline does not design in a vacuum; rather, each discipline produces a holistic design that can be constructed in accordance with the Contract.

Our construction-driven execution approach begins with incorporating safety into the start of any process or procedure. Our commitment to safety is paramount, and it will not be sacrificed for cost or productivity. It is appropriate to present our commitment to Safety as the first and primary step in our Project Management Plan.

GLX Constructors' first priority is safe and secure Project execution. The following highlights our HSE Program, which is drawn from Fluor Enterprise's global, company-wide safety program and adopted to promote HSE processes in executing the Green Line Extension DB Project.

We have based our HSE Management System on a Continuous Improvement Model as contained in international standards such as ANSI Z 10, OHSAS 18002:2008, and ISO 14001:20015. This model is shown in Figure 3.1-9.

This establishes our commitment to the HSE process by providing a documented company HSE Policy. The HSE Policy is appropriate to our business strategy and culture, and it sets the direction of the HSE Management System. Additionally, we will include the MBTA and third-party stakeholders into our HSE Plan to provide a safe work place across the Project.

All GLX Constructors personnel are held responsible, empowered, and accountable to work together as a team to execute all HSE-related systems and processes. GLX Constructors is committed to providing a healthy and safe workplace for all personnel at each of its offices and project sites; for stakeholders, the MBTA's personnel, and riders; and to protecting the environment in accordance with applicable laws and our HSE Policy.



Figure 3.1-9. HSE Management System Continuous Improvement Model. Our commitment to safety is the first step in establishing our Construction Management concept. We constantly improve our processes through our Continuous Improvement Model.



Safety will not be sacrificed for the sake of cost savings or increased productivity.

GLX Constructors' commitment is based on the principle that accidents are preventable and risks will be controlled to a level that is as low as reasonably practicable.

GLX Constructors Management's unequivocal commitment to HSE is at the foundation of our values and culture.

We will execute our HSE Policy by:

- ▶ Adopting recognized standards, applicable codes of practice, and relevant statutory provisions.
- ▶ Incorporating recognized HSE standards into engineering, design and, construction processes.
- ▶ Providing effective training, communication, and continual performance review.
- ▶ Establishing realistic and challenging tasks and performance targets for employees.
- ▶ Setting GLX Constructors team objectives and targets on an annual basis and assigning accountability for meeting these objectives and targets.
- ▶ Preparing and implementing HSE documentation in accordance with HSE, JV partner, and client requirements.
- ▶ Regularly auditing implementation of the HSE Management System.
- ▶ Working with the MBTA and our subcontractors to continually improve HSE performance.
- ▶ Developing communication and control networks.
- ▶ Monitoring, measuring, and reporting HSE performance.
- ▶ Conducting training to help all personnel understand their responsibilities, and empower them for continual improvement.

As illustrated in Figure 3.1-10, Our HSE Management System provides an integrated tool – a set of practices – to implement the HSE program and execute GLX Constructors' commitment to continually improving HSE performance.

Our HSE Management System and complements our Management Plan by considering the following six key metrics:

- ▶ Sustainable development
- ▶ Risk management
- ▶ Accountability to community

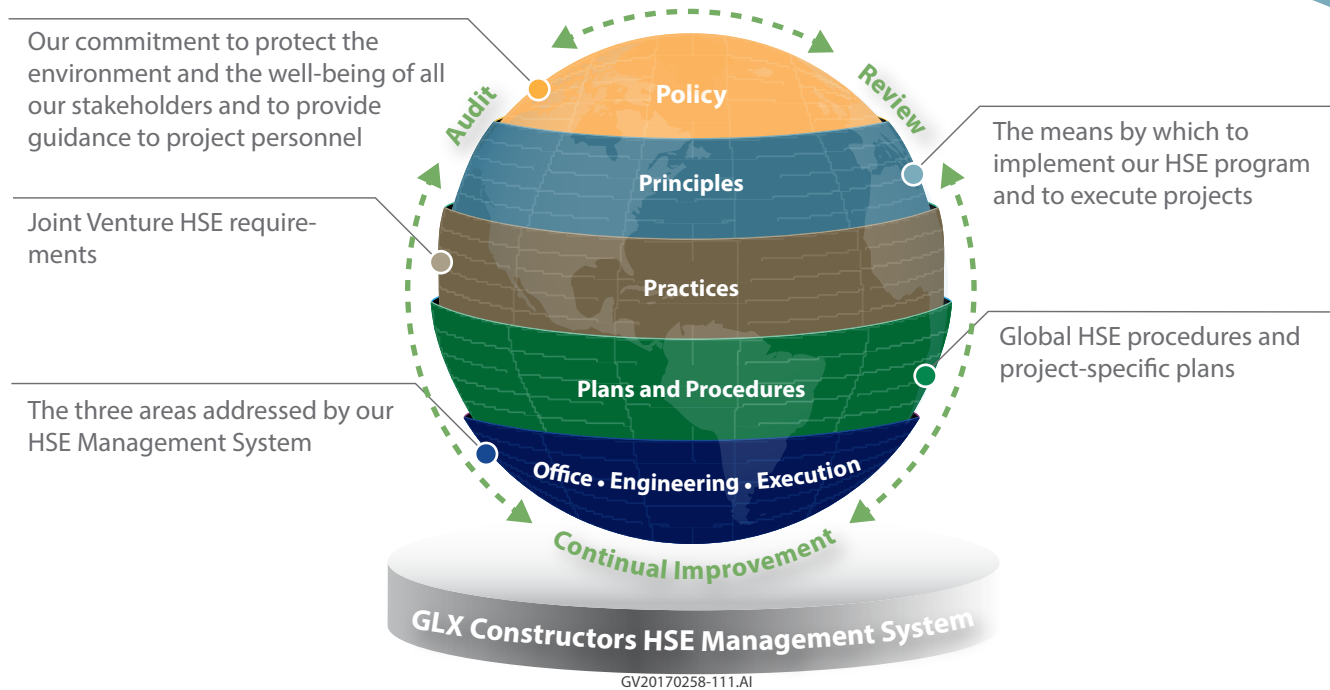

Figure 3.1-10. GLX Constructors’ Health, Safety, and Environment Management System. *Our HSE Management System allows GLX Constructors to consistently deliver distinctive solutions to improve the life cycle of our projects and promote the wellbeing of our employees, clients, and the communities in which we work and live.*

- ▶ Cross-discipline cooperation
- ▶ Best practices
- ▶ Requirements applicable to the scope of work (e.g., regulatory, JV partner, and Contract requirements)



Construction zones present safety hazards due to a variety of reasons, from working in close proximity to traffic, to the dangers of working around heavy equipment, to working in an active rail corridor. GLX Constructors understands working in urban environments and confined areas, and we will coordinate with the active rail lines, adjacent property owners, and local jurisdictions to safeguard optimum construction operations. We have identified public roads along the corridor for our construction crews to safely access specific work areas, which will provide adequate access with minimal community impacts. Our approach is to promote safe and efficient movement – for motorists, bicyclists, and pedestrians – through and around work zones while protecting workers and equipment.

As transit contractors, our firms operate and maintain large fleets of hy-rail equipment and work trains. We understand the dangers and risks of rail equipment, and we fully appreciate the safety implications of operating in an active rail corridor. We have the safety procedures and resources in place to protect a safe working environment with this equipment.

Project Manager, John West, leads a morning safety meeting before the crews begin their daily work to meet or exceed their project’s schedule needs.

HSE incident prevention is a primary responsibility of all levels of the organization. Each manager is directed to use maximum initiative in communication, training, motivation, and monitoring techniques to apply every reasonable precaution to prevent incidents. Each employee and individual entering the Project is expected to take appropriate steps to eliminate incidents in the workplace.

The HSE professional staff at the project site, will directly assist management as well as the work force in the execution of the HSE Management System. HSE Representatives will be responsible for consulting with management in matters affecting the environment and the health and safety of employees, contractor personnel, clients, and the community. Incident prevention responsibilities of managers cannot be delegated.

This site-specific HSE Plan will be developed in conjunction with the Legal and Other Requirements Register and the HSE Management system Compliance and equivalency process. Together, the HSE Procedures and HSE Plan comprise the site-specific HSE Manual, which will be the foundation for the Project's program implementation.

GLX Constructors not only monitors the standard lagging indicators for HSE performance but focuses on key HSE Leading Indicators. Leading indicators are the results of positive behaviors, a measurement of what is going right, are aimed at the future, and can be directly and quickly influenced. Leading indicators produce proactive data. If we solely focus on lagging indicators, we are working reactively; when we also focus on leading indicators, we are working pro-actively.

Tracking and trending of leading indicators allows GLX Constructors to analyze and drive the required behaviors and provides for continual improvement of the culture. Leading indicators enable us to identify and correct process deficiencies before they produce undesirable results and include.

- ▶ **Tracking severity rates** for all incidents including near misses, to allow improved tracking of key areas which increase likelihood of incidents so that action can be taken to tackle the risk prior to a serious incident.
- ▶ **HSE Weekly Assessments.** Required to ensure all areas of the work are regularly inspected.
- ▶ **Management Participation in Assessments.** Senior project management is involved in HSE assessments on a weekly basis. This not only allows management to observe what is happening in the field but also drives safety excellence and demonstrates its importance to all on site by being involved; this is management in action relative to HSE.

Measurement tools are used to confirm that the HSE Management System is being executed and implemented correctly. They also measure performance, monitor effectiveness, and evaluate changes to the system. Evaluation and feedback loops are an integral part of the HSE Management System.

Measurement and evaluation tools include:

- ▶ **Audit.** Auditing is the primary tool for measuring performance. The following audit protocols will be developed and executed:
 - ◆ Systems audit. To measure implementation and effectiveness of the HSE Management System.
 - ◆ Compliance audit. To measure compliance with the HSE practices and project-specific procedures.
 - ◆ Performance audit. To measure whether the expected performance level is being met.
- ▶ **Measurement Process.** Performance measurement processes will be implemented to assess the overall effectiveness of the HSE Management System.
- ▶ **Client Review.** An evaluation process will be developed at the project to gain feedback from MBTA.
- ▶ **GLX Constructors' Project Offices.** The Project office will evaluate the effectiveness of the HSE Management System and provide suggestions on continued improvements.
- ▶ **HSE Alignment Process.** HSE professionals involved in the alignment process before and during project startup will identify key areas of the project/site that require particular attention, and adopt or create procedures that are tailored to the project/site.

Responsibilities of the Named Individuals Shown in the Construction Organization

Our proposed Construction Organization chart is illustrated in Figure 3.1-11. The responsibilities of the named individuals shown on the Construction Organization Chart are as listed below.

Project Manager John West will lead our Construction Team. John has over 40 years of experience in heavy/civil and track construction, and he will be dedicated to the Green Line Extension DB Project full time. As a Project Manager, John has overseen all aspects of nearly \$3 billion in construction and transit projects, including the \$876 million Silicon Valley Berryessa Light Rail Extension DB Project in Milpitas, California, and the \$438 million RTD West Rail Line Project in Denver, Colorado, in which he delivered the project eight weeks ahead of schedule. John will be responsible for overall project design and construction operations, and he will have an informal line of communication to the Quality Manager and Project Safety and Security Manager. The Quality Manager and Project Safety and Security Manager will remain independent from the Construction operations, but will maintain a direct line of communication with and will report to our Project Executive, Clyde Joseph.

Name	Role	Responsibilities	Dedication to the Project
John West	Project Manager	Responsible for overall project design and construction operations.	Full time and will begin their assignment upon Project onset.
Jamie Doyle	Construction Manager	Responsible for all operations of infrastructure construction, including right-of-way (ROW); grading and alignment; drainage; utilities; structures, including bridge and wall construction; track; station; and VMF construction.	Full time and will begin their assignment upon Project onset.
Michael Hoitink	Design Build Coordinator	Responsible for managing the Design Team through the design phase and will transition into the role of Construction Engineering Manager during the Construction Phase of the Project.	Full time and will begin their assignment upon Project onset.
Aaron Neeley	Systems Integration Manager and Testing and Commissioning Manager	Responsible for the Systems Integration Design and Construction, including the Overhead Contact System (OCS), communications systems, and Traction Power Systems.	Full time and will begin their assignment upon Project onset.
Sam Choy	Business Services Manager	Manages the Business Services Team, including finance, administration, and procurement.	Full time and will begin their assignment upon Project onset.
Bob Horn	Project Controls Manager	Manages project Controls and scheduling.	Full time and will begin their assignment upon Project onset.

Figure 3.1-11. Individuals on the Construction Organization Chart. *Successfully performing these roles are critical to the success of a DB project of the size and complexity of the Green Line Extension DB Project. GLX Constructors’ personnel have the skills and experience to get the job done right the first time.*

Jamie, Michael, Aaron, Sam, and Bob will assist John West in his role as Project Manager. They will lead the constructability reviews of the Project design as it progresses from TWGs through final design.

Management and Integration of Subcontractors and Suppliers

We will fully integrate our subcontractors and suppliers into the Project through on-site orientations and HSE training, which will serve to familiarize them with our policies and procedures. Training also implements the subcontractor or supplier’s individual QA/QC Program into our overall Project QA/QC Plan and establishes contractual communication lines.

We will incorporate the subcontractor or supplier’s schedule information into our overall Construction Schedule, providing additional detail as necessary, to properly manage timely execution of the work. GLX Constructors will commit a direct, dedicated supervisor to each subcontractor and supplier to maintain immediate communication.

GLX Constructors will manage subcontractors and suppliers to comply with all regulatory requirements. Our process begins with issuing proposal packages and Contract documents through our Contracts and Procurements Department. This department will be under the leadership of Sam Choy, our Business Services Manager.

Upon Project Award and negotiation of a detailed scope of work or supply, we will issue the Contract for signature. Following, we will delegate subcontractor

and supplier field management to the construction discipline's Project Engineer and Superintendent under the leadership of John West, our Project Manager, and Jamie Doyle, our Construction Manager.

We maintain subcontractor and supplier coordination on a daily basis with the Project Engineer, Superintendent, and subcontractor, including safety orientations, daily and weekly safety toolbox meetings, QA/QC meetings, and weekly scheduling meetings. In addition, our Project Safety and Security Manager, Chris Poe, and Quality Manager, Sandro Plutino, will have a direct line of contact and communication with the subcontractor or supplier to effectively integrate and manage all requirements of their contract.

3.1.D INTERNAL COORDINATION

The initial Project Management Plan shall describe the interrelationships and interfaces between each discipline within the Proposer's organization (e.g., design, design check, construction, Project controls, and quality management).

Interrelationships and Interfaces between Each Discipline

Our construction-driven execution approach fully integrates the Design, Design and Construction Review, Quality (design and construction), Safety, Construction, and Project Controls Teams into the design, approval, and construction process.

After Project Award, we will reconvene each of the design disciplines' TWG Meetings. As discussed in earlier in this section, these TWGs began during the Proposal Phase with the intention to produce updated design solutions to allow Pricing Proposals to be completed. Each TWG is co-led by the Discipline Design Lead and the Construction Discipline's Project Engineer and Superintendent.

As the Project's design progresses through each TWGs Illustrated in Figure 3.1-12, the Technical Design Reviewers, Project Engineers, the MBTA, and appropriate third-party stakeholders will review and comment on the design. The Project Safety and Security Manager reviews the design for development of potential hazards and analysis for mitigation, the Quality Manager develops inspection and testing plans, and the scheduling lead reviews the design for incorporation of additional detail into the Project Schedule and Cost controls.

We embed the MBTA and appropriate third-party stakeholders in this process to provide immediate feedback to the designer, and streamlines the review, comment, and reconciliation process at each TWG checkpoint, which will expedite the overall Project Schedule.

“GLX Constructors is fully committed to working together as a team. We have intentionally formed this Joint Venture partnership based on our shared corporate values and mutual commitments to the MBTA's Green Line Extension DB Project goals. We will achieve the requisite cost and schedule certainty through the internal and external relationships necessary to drive successful Project execution.”

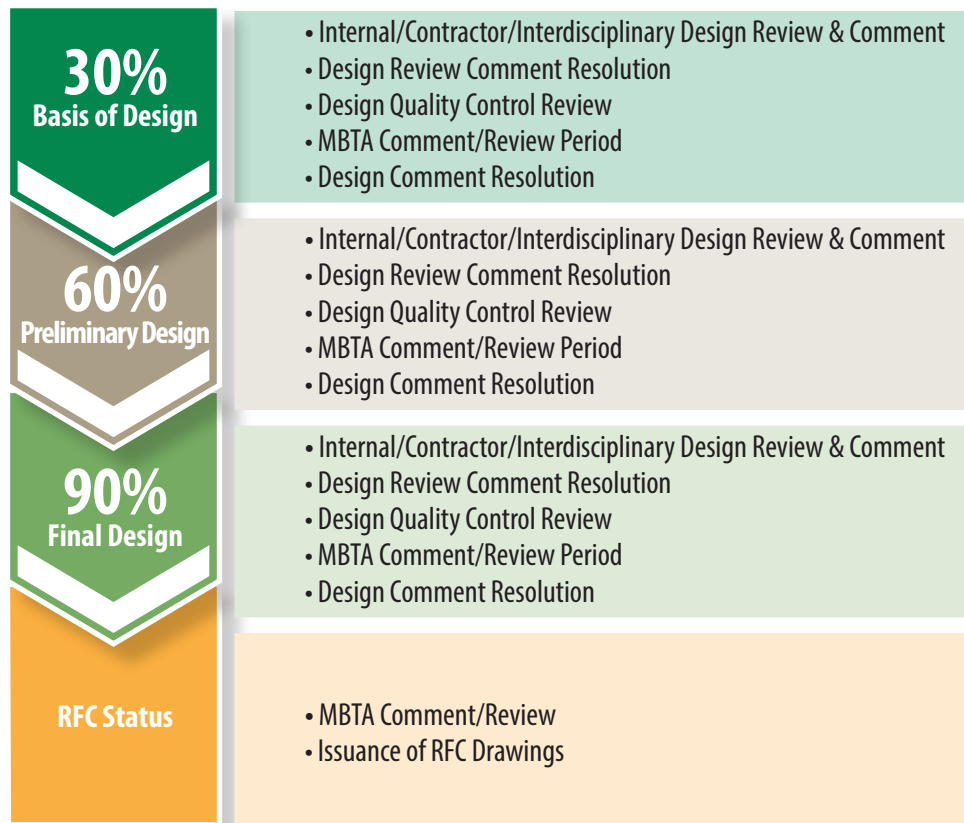

GV20170258-052.INDD

Figure 3.1-12. Design Package Progression. *The progression of the Design Package demonstrates the collaboration that is required between the Design Team, the Construction Team, and the MBTA.*

As the design progresses to the final design stage (90%), the Construction Discipline Project Engineer and Superintendent will prepare Construction Work Plans (CWP) to define and control the design element’s construction. Figure 3.1-13 illustrates a CWP checklist. These CWPs include the design plans and specifications, any detailed work sequence drawings required for construction, associated submittals for review, and approval by the Engineer of Record (EOR) and bills of material.

✓ 1.0 General Information	✓ 7.0 Quality Requirements
✓ 2.0 Work Activity Sequence	✓ 8.0 Key Project Contacts
✓ 3.0 Safety Plan	✓ 9.0 Environmental
✓ 4.0 Project Controls Information	✓ 10.0 Permit Requirements
✓ 5.0 Key Equipment and Resources	✓ 11.0 Management Approval
✓ 6.0 Bill of Materials	✓ 12.0 Crew Review

GV20170258-062.INDD

Figure 3.1-13. Construction Work Plan Checklist. *Before beginning construction activities, it is critical to have all construction elements in one, easily accessible place.*

Mirroring the design phase, the Project Safety and Security Manager reviews the CWP to identify potential hazards and, if necessary, develops procedures for eliminating or mitigating the hazards. The Quality Manager develops Inspection and Testing Plans and specific checkpoints. The Environmental Manager reviews the CWP for compliance with our Project's Environmental Plan. The Project Controls Team reviews the CWP to provide the required schedule completion dates and the associated cost control metrics.

The finalized CWP is submitted to the DB Management Team and the MBTA for review; after its approval, it is able to move forward with construction.

Incorporating Construction, Safety, Quality, Environmental, and Project Controls Teams; DB Management Team; the MBTA; and appropriate third-party stakeholders into the design and construction process provides the most efficient and economical construction solution. All parties "buy in" to our proposed solution, and any potential changes or "surprises" during construction are either minimized or eliminated.

3.1.E EXTERNAL COORDINATION

As members of the community, we understand the reach of the Green Line's influence in the greater Boston area. Coupled with our large-scale project experience, GLX Constructors' homegrown relationships and nuanced understanding of the local community will lay the foundation for our public outreach communication program, third party management, and stakeholder relationships. Our experience with these interfaces will offer the MBTA a safer Project execution, more satisfied community members, and fewer complaints from the public arena.

Interrelationships and Interfaces between GLX Constructors and Others

As detailed above, we include the MBTA and appropriate third-party stakeholders into the development, review, approval, and construction of each design element. During this process, we identify key interface points with the local communities, and we engage the Public Information Office to develop proactive approaches to communicating with the third-party stakeholders.

Our experience has proven this proactive process will facilitate timely review and construction approval. Additionally, it provides the local communities with a transparent and simple approach to relevant construction notifications.

Reviews of Plans and Permits

The Construction Project Engineers are responsible for permits in each of their respective disciplines.



Paired with our familiarity with the MBTA's policies and procedures, GLX Constructors has managed design internally and externally on a national stage. This will give the MBTA confidence about our ability to effectively manage our design processes through to the end of Project completion.



Coupled with our large-scale project experience, GLX Constructors' homegrown relationships and nuanced understanding of the local community will lay the foundation for our public outreach communication program, third party management, and stakeholder relationships.

During TWGs, the Construction, DB Management, Quality, Safety, and Environmental Teams; the MBTA; and associated third-party agencies simultaneously review the design. As each Design Phase completes, the our Construction Team reviews the Design Package at the same time as the Design Quality Manager, who signs off on the design for Contract compliance. The Design Package is then transmitted to the MBTA and necessary third-party agencies for review and comment. By incorporating the MBTA and third-party agencies into the ongoing design process, this streamlines their review and comment period, which minimizes comments for resolution.

After the MBTA and third-party agencies review and comment on the Design Package, it is returned to the Design Discipline Lead to resolve review comments, and continue the design to the next completion point where the process is repeated.

After the final design is completed and comments are resolved, the Design Package is stamped, signed, and released for construction (RFC) to the Construction Team for execution.

Progress, Workshop, Partnering, and Utility Coordination Meetings

The Kickoff Meeting with the MBTA is critical and will set the foundation for our partnership moving forward. This is an essential step for integration with the MBTA, and move forward together with executing the Green Line Extension DB Project in an effective, trustworthy partnership.

We will propose initial partnering sessions with follow-up reviews on a quarterly basis, or more frequently if necessary. We also hold Project team alignment meetings to make certain our team performs to the highest degree, and will extend the courtesy to the MBTA and third-party stakeholders.

TWG meetings are scheduled on a weekly basis, during which design decisions are documented from the previous week and new concepts are brought forward for resolution. Additional workshop meetings and Over-the-Shoulder Reviews are scheduled as needed to facilitate the design review, comment, and approval process. These meetings include necessary Utility Coordination meetings, which are part of the Utilities and Drainage TWG. We hold weekly Schedule Progress Meetings to review and update the design and construction schedule and prepare the progress reports.

Our organization includes in-depth risk management meetings on a quarterly basis, and risk register reviews on a monthly basis.

Construction, Engineering, and Inspection Activities

As the Construction Work Plans (CWPs) are developed from our final design solutions, the QA/QC Inspection and Testing Plan for each work plan is

GREENBUSH LINE RAIL RESTORATION DESIGN BUILD

South Shore, Massachusetts

The first ever Design Build project executed by the MBTA – was awarded the 2006 American Road and Transportation Builders Association (ARBT) “PRIDE” First Place Private Sector Award for its most successful community outreach effort. The project team instituted a thorough and effective public outreach program, including a 24-hour dedicated “hot line” and a culture of continuous outreach to neighborhoods affected by the construction. Regular meetings were held to inform the affected communities of progress to date and upcoming milestones, particularly in terms of road closures and utility relocations. Community outreach and public information was managed by a full-time public information officer responsible for all coordination of community involvement and community feedback.



developed, reviewed, and approved by the Quality Manager to be included in the CWP. Additionally, safety check points and Job Hazard Analyses are prepared to allow for safe work construction. Any environmental concerns are addressed in accordance with industry Best Management Practices and the Project-specific Environmental Management plan.

Community Outreach

Where specific design or construction directly impacts the community, GLX Constructors’ Title VI Program Lead, Hannah Brockhaus, will provide input and schedule community outreach meetings when appropriate. This will allow the MBTA, with support from GLX Constructors, to clearly and accurately present the community with Project updates.

The development of the design and our Project management sets up the Title VI Program Lead to easily identify specific interface points between construction and third-party stakeholders. Specifically, we are prepared that the communities of Medford, Somerville, and Cambridge, as well as the area surrounding Tufts University, will require in-depth analysis to produce the most effective program for public involvement, comment, and input. This will also set the groundwork to create a process of continuous feedback that will lead to communications improvements.

A similar process was used by GLX Constructors’ team member, Fluor Enterprises, Inc., on the Tappan Zee Bridge Hudson River Crossing DB Project for the New York State Thruway Authority, and on the Purple Line Transit DB Project for the Maryland Department of Transportation and Maryland Transit Administration. On the Tappan Zee Bridge Project, multiple construction zones were located immediately adjacent to local communities. As such, the Project required extensive pre-planning for a noise control plan that sufficiently notified third-party stakeholders. We carried our approach over to the Purple Line Transit DB Project, which required extensive collaboration and planning for the section of the rail line that traversed directly through



To support the MBTA’s third-party stakeholder goals, we have a local, proficient Title VI Program Lead who will disseminate information on upcoming construction activities and provide status updates to the community at regular intervals about our construction progress as we move toward the Project’s successful completion.

the University of Maryland's campus. In both instances, our Public Outreach Programs were collaborative, engaging, and successful.

GLX Constructors' construction-driven approach to design and construction produces a collaborative, economical, efficient, and inclusive process for safe and quality construction. Our approach allows for schedule and cost certainty, both for the MBTA and GLX Constructors. Our partnering approach fosters collaboration and timely problem solving and solutions to eliminate rework, mitigate impacts to the MBTA and the local communities and transit ridership. Our approach will ensure the MBTA is represented in a positive light with the public and media outlets.



In partnership with the UDOT Public Information Team, a Fluor-led Joint Venture won the 2013 ARTBA Pride Award for outstanding Public Outreach associated with the I-15 CORE Project.

APPENDIX 1

Design Discipline Lead Résumés

SEAN BARRY, PE

Utilities Design Discipline Lead

Valuable Experience:

- ✓ MBTA
- ✓ Extensive rail transit
- ✓ Power systems
- ✓ Power facility operations
- ✓ Infrastructure improvements
- ✓ Design disciplines
- ✓ Construction teams

Years of Experience: 21

Education: B.S., Civil Engineering, University of Massachusetts, Amherst

Professional License/Certification: Professional Engineer, MA #41802

Sean has more than 20 years of experience in the design and construction phases of civil engineering projects. He has provided engineering services for numerous utility and roadway projects that have involved the installation of water, sewer, drainage, gas, power, and telecommunications improvements. His responsibilities have included the inventory, inspection, evaluation, relocation, and protection of utilities, as well as contract administration, budget and schedule oversight, reporting, recording, and staff supervision. As a lead project engineer on the seven station designs for the MBTA Greenbush Line Rail Restoration Design-Build, he designed various site stormwater systems that implement the Massachusetts Department of Environmental Protection's stormwater management standards, particularly the sizing of innovative/alternative stormwater control and underground detention and infiltration systems following best management practices. Sean has also been a project engineer on several Massachusetts Water Resources Authority and local municipality projects, as well as bridge, infrastructure, and roadway projects. Additionally, he is experienced in addressing delicate project issues, including ROW and abutter concerns, during the public hearing phase of the project permitting process.

DESCRIPTION OF COMPARABLE PROJECTS

City of Somerville, Central Broadway/Winter Hill Roadway and Streetscape Improvements Study and Design, Somerville, Massachusetts, Project Manager. Sean oversaw the design of roadway and streetscape improvements to a 1-mile corridor. He coordinated efforts with STV traffic engineers and survey, landscaping, and public outreach subconsultants. Phase I included a traffic study of existing conditions and the development of preliminary layouts of proposed roadway and streetscaping improvements, including bicycle lanes and additional green space. The firm developed three alternatives and led public meetings and presentations. Sean oversaw the development of final plans and bid documents for the preferred option, which is a "complete street" concept that calls for cycle tracks on both sides of Broadway separated from traffic by a parking lane.

MBTA, Greenbush Line Rail Restoration Design Build, Braintree, Weymouth, Hingham, Cohasset, and Scituate, Massachusetts, Project Engineer. Sean prepared site layout grading and drainage designs, as well design packages for various at-grade roadway crossings and seven rail stations, for the \$320 million restoration of this commuter rail line. Sean was responsible for designing packages for 15%, 30%, 60%, 90%, and 100% submittals to the MBTA, the engineer/contractor, and the various towns for approval. His other tasks included coordination with other design disciplines (track drainage, structural, electrical, architectural, and traffic professionals) and the preparation of and response to RFI documents during the design and construction process. Sean responded to QA/QC requests from the towns, MassDOT, and the MBTA. He was actively involved in the public outreach process and provided engineering design support during the question and answer phases of those meetings. He also oversaw the revision to and implementation of sensitive ROW and mitigation agreements into the designs and assisted in local, state, and federal permitting tasks. Additionally, Sean prepared and coordinated design changes to contract documents, issued field memos, and provided civil construction phase services to the engineer/contractor to resolve any construction issues.

MBTA, Wellington Carhouse Expansion and Improvements, Medford, Massachusetts, Lead Civil Engineer. Sean managed the development of civil plans and specifications for the MBTA's planned expansion and renovation of the Wellington Carhouse. The project will expand the facility's east side by 12,000 sf and renovate the existing 120,000-sf space. The improvements will allow the MBTA to maintain 152 new, state-of-the-art Orange Line cars that are to replace the agency's current fleet of 120 cars. Sean was responsible for overseeing civil design submittals at the 60%, 90%, and 100% levels of completion. His work involved coordinating with other design disciplines, including track, structural, electrical, traction power, plumbing, fire protection, and architectural professionals. Sean also prepared documents depicting design constraints and requests for a variance from the MBTA's track clearance envelope for work adjacent to active service operations at the Wellington Station.

Town of Barnstable, Lincoln Road Reconstruction, Hyannis, Massachusetts, Project Manager. Sean is managing the development of plans for the \$1.5 million reconstruction of 0.75 mile of roadway between Route 28 and West Main Street. His team has developed roadway geometry, cross section, traffic calming elements, pedestrian crossings, handicapped accessibility, pavement markings and signage, and alignment of a shared use bicycle and pedestrian path. The team has also identified impacts to abutters, utilities, and the existing drainage system while minimizing utility relocations and reusing as much of the existing drainage system as possible to minimize costs. The pavement design calls for recycling the existing asphalt and using it for the base course under the new roadway.

PAUL BOBBY, PE

Track Design Discipline Lead

Valuable Experience:

- ✓ Track design of light rail expansions
- ✓ Design of track alignment
- ✓ Geometry
- ✓ ROW and utility conflict identification
- ✓ Construction staging plans

Years of Experience: 18

Education: B.S., Civil Engineering, University of Wisconsin/Platteville

Professional Licenses/Certifications: Professional Engineer, Georgia # PE034469, Illinois #058268, Indiana #PE10708276, North Carolina #043621, Wisconsin #38452-6

Paul is a track designer with more than 15 years of experience in the design and construction of rail improvements. He began his career as a track laborer for the Wisconsin Central Ltd. (now Canadian National Railway Company), and has since earned a solid reputation within the rail industry for his knowledge of light rail, passenger, and freight rail design programs. He served as Lead Rail Engineer for the \$120 million Chicago Transit Authority (CTA) Block 37 Station and Tunnel Connector, for which he provided design of a 2-track connection between the Blue and Red transit lines. He has also served as lead rail engineer for several capacity improvement projects, including work for CSXT, Norfolk Southern Railway, and Kansas City Southern. In addition, Paul has provided project management for blanket civil/structural and project administration contracts with Metra, including more than 20 assigned tasks, all completed within budget and on schedule.

DESCRIPTION OF COMPARABLE PROJECTS

City of Ottawa, O-Train Expansion, Ottawa, Ontario, Lead Track Engineer.

Paul oversaw the design of track and acceptance inspection activities during the service expansion of the O-Train light rail transit system in Ottawa, Ontario. To accommodate increased ridership on the 5-mile (8-km), single-track, diesel multiple unit (DMU) rail system, the city initiated efforts to install two new passing sidings on the single-track system. As part of this design-build effort, activities also included the replacement of the Ellwood Diamond (a crossing of the O-Train and the Canadian Northern Railway), signal system upgrades, civil grading and drainage, utility relocations, additional storage tracks at Walkley Yard, improvements to the Walkley Maintenance Facility, passenger station enhancements, and the acquisition of six new DMU train sets. As part of this effort, Paul's responsibilities included developing the preliminary configurations for the two passing sidings, as well as performing acceptance inspection of the track work. In addition, he contributed to the preparation of an advanced material package and prepared bid documents.

IDOT, Granite City to St. Louis Corridor Phase I Environmental Studies, Granite City, Illinois and St. Louis, Missouri, Project Manager/Project Engineer. Paul is supervising preliminary engineering efforts during Phase I services for all work associated with the preparation of the Environmental Impact Study for the expansion of high-speed rail (HSR) service between Granite City and St. Louis for the Illinois Department of Transportation (IDOT). The 284-mile-long Chicago to St. Louis Corridor transportation network consists of highway, air, and rail (Amtrak) service. The purpose of the IDOT Chicago to St. Louis HSR Program is to improve rail service and to establish a more balanced use of the multimodal transportation network. As with the rest of the corridor, the 20-mile section of rail through Madison and St. Clair counties currently operates on one set of tracks. The design team is working to identify a preferred alternative to allow speeds up to 79 mph through the study section and increase on-time reliability for Amtrak service. The firm's scope of work includes data collection, preparation of base maps and mosaics, geometric studies, capacity analysis, railroad coordination, environmental field studies and reviews, cost estimates, and public involvement. Paul is providing overall project coordination of all engineering tasks, managing the firm's financial reporting, and reviewing all railroad alignments and feasibility analyses.

St. Louis Metro, East Riverfront Interlocking, St. Louis, Missouri, Project Engineer. Paul oversaw the track design for a new diamond interlocking located between St. Louis Metro's existing East Riverfront light-rail station and the Eads Bridge spanning the Mississippi River. The Eads Bridge is a 2-level structure carrying two sets of tracks for the MetroRail transit system on its lower level and a 4-lane highway on the upper level. The new interlocking is located in an area east of the bridge known as the East Arcade. Paul and his team designed the new interlocking on a tight schedule and within a restricted area, which made design work challenging. The project required the installation of an asymmetrical double crossover using a combination of No. 6 and No. 8 turnouts on concrete ties to allow single-track operation over the Eads Bridge with minimal disruption to the passenger rail service while the bridge is rehabilitated. This project had an aggressive completion schedule, which required the firm to develop an independent material procurement package in advance of the construction contract. Paul directed the track design for the new interlocking and reviewed the final plans, successfully meeting the aggressive schedule.

DAVID BORGER, PE

Technical Advisor

Valuable Experience:

- ✓ Design build
- ✓ Light rail projects
- ✓ Complex systems
- ✓ Facility designs

Years of Experience: 43

Education: M.S., Civil Engineering, New Jersey Institute of Technology
B.S., Civil Engineering, Newark College of Engineering

**Professional Licenses/
Certifications:** Registered Professional Civil Engineer,
NJ # 24GE02673700
Professional Planner (PP), NJ# 33LI00402800

An industrial engineer with more than 40 years of diverse management and design experience, David has been responsible for supervision of complex systems and facility design including trackwork; communications; traction power; signals; equipment selection and layout; and yard planning, layout, and design, including several projects delivered to the Los Angeles County Metropolitan Transportation Authority (Metro) and other transit operators throughout the country. Notable projects completed under David's direction include NJ TRANSIT's Hudson-Bergen Light Rail Transit DBOM and construction management for Metro's Gold Line (Blue Line) light rail system to Pasadena.

DESCRIPTION OF COMPARABLE PROJECTS

NJ TRANSIT, Hudson-Bergen Light Rail Transit DBOM, Hudson and Bergen Counties, New Jersey, Systems Design Manager. David managed the industrial engineering design for the 10-mile-long initial operating segment of this \$1 billion, 20-mile light rail system. In an effort to alleviate bus and automobile congestion in Hudson County and improve access to Bergen County, as well as to meet projected ridership forecasts, the project involved civil/right-of-way, structural, and industrial engineering design services. David supervised a multidisciplinary design team for the track and systems design of the alignment, which consisted of at-grade and elevated sections employing ballasted, direct fixation, and embedded track. He also made sure that the track and systems design were integrated with the system's 16 stations, maintenance facility, and yard. The system was subsequently expanded to run more than 20 miles between Bayonne in Hudson County and the Vince Lombardi Park/Ride Facility in Bergen County, and include 33 stations.

Metro Pasadena, Metro Blue Line (Gold Line) Light Rail, Los Angeles to East Pasadena, California, Principal-in-Charge. David held overall responsibility for the construction management (CM) of this 13.6-mile,

\$865 million light rail system — completed by the Los Angeles Pasadena Blue Line Construction Authority as part of the Gold Line. He oversaw a 12-member CM staff and 20 subconsultants responsible for performing design and constructability reviews, resident engineering and inspection, QA/QC, systemwide and facilities engineering support, and systems integration. He was responsible for the design and constructability review of each construction package to reduce costs and to avoid claims. David managed the QA/QC program, including supervision of the area manager and all resident engineering and inspection activities, to see that all quality objectives were met and documented. He supervised extensive coordination with the cities of Los Angeles, South Pasadena, and Pasadena, as well as with the California Department of Transportation, to continue the maintenance and protection of traffic on the many busy freeways and roads impacted by the project. David also oversaw coordination with these cities, as well as local businesses and communities, to keep them informed about construction activities and to incorporate their concerns into the construction program. He also made certain that the project's safety program objectives were met or exceeded.

RCTC, Perris Valley Line, Riverside to Perris, California,

Principal-in-Charge. David is responsible for maintaining executive oversight of planning, design, and construction services for the 24-mile Riverside County Transportation Commission (RCTC) extension of the Metrolink commuter rail system. The scope of the \$247.2 million project includes rehabilitation of more than 20 miles of existing track, upgrade, or closure of multiple grade crossings, installation of a signal system, replacement of two railroad bridges, and design for four new stations and a new layover facility with locomotive service and inspection areas. Under David's oversight, the firm kept the design on schedule and within budget despite scope changes by the client. The firm is currently providing design support during construction, including response to requests for information; change order review and resulting design revisions; submittal and shop drawing review; nonconformance reports, as needed; and oversight of systems inspection, testing, and startup by the systems subconsultant.

SMART, Initial Operating Segment Design-Build, San Rafael to San Rose, California, Principal-in-Charge.

David is providing executive oversight of design services for all civil, track, and structural improvements for the initial operating segment of Sonoma-Marín Area Rail Transit District (SMART) implementation of passenger rail service along the Northwestern Pacific Railroad corridor. STV's scope of work for the \$360 million design-build project includes the rehabilitation or replacement of 37 miles of track, 16 bridges, and numerous grade crossings along the alignment between San Rafael and Santa Rosa, CA. The firm is also designing the boarding platforms for the segment's seven stations.

MARTIN BOYLE

Technical Advisor

Valuable Experience:

- ✓ Design build
- ✓ LRT
- ✓ MBTA
- ✓ Multi-billion dollar projects
- ✓ Systems integration
- ✓ Start-up, and testing

Years of Experience: 50

Education: A.S., Business Administration, Fisher College

Martin, the MBTA's former Superintendent of Transmission and Distribution, has unparalleled experience managing the design, construction, and maintenance of electrified transit systems and vehicles. He joined STV to manage the Houston Metropolitan Transit Authority (METRO) light rail transit (LRT) starter line as the vehicle/systems manager. This project was successfully delivered to the community in less than four years from the start of design to revenue service. Martin has since served as the construction manager of rail systems for the Charlotte Area Transit System (CATS) LYNX Blue Line LRT, the first of five routes in a \$3.9 billion transit program.

DESCRIPTION OF COMPARABLE PROJECTS

City of Ottawa, Confederation Line LRT, Ottawa, Canada, Senior Advisor.

Martin is serving as Senior Advisor responsible for providing supervisory support for development of preliminary engineering necessary for the transition of Ottawa's exclusive, fully built-out bus rapid transit system to an LRT network. The approximately 7.8-mile electric line will feature 13 stations, four inside of a nearly 2-mile-long tunnel under downtown Ottawa. This bored tunnel presents another major challenge, as it will burrow beneath federal lands and buildings in the Canadian capital. To mitigate any potential impacts, the firm is coordinating with applicable stakeholders and complying with all requisite federal rules and regulations. The project also involves the construction of a new maintenance and storage facility to service the LRT fleet, and the firm is providing preliminary engineering services for this structure as well. The firm is currently coordinating with a joint venture partner on project management and project controls. In addition to preliminary design and final design and construction specifications, the firm is responsible for scheduling services, including construction staging.

CATS, LYNX Blue Line Extension, Charlotte, North Carolina,

Principal-in-Charge. As Principal-in-Charge, Martin has overall responsibility for transportation planning, environmental investigations and documentation, and preliminary engineering services to 65% design for a 9.3-mile extension of the Charlotte Area Transit System (CATS) Blue Line. The estimated \$1.16 billion extension from the city's central business district to the University of North Carolina at Charlotte includes 11 stations, three parking garages, one surface parking lot, and a storage yard with an operations building. The firm worked

with CATS to identify more than \$200 million in value engineering and project scope reductions, and accelerated the corresponding redesign and supplemental environmental investigations to incorporate the project changes into the Final Environmental Impact Statement that was submitted to FTA in 2011. The firm is also working with CATS to successfully integrate transit and land use on the extension and to solve challenges associated with crossing and running along existing freight railroad ROW. Because the BLE runs through developed areas, extensive utility coordination is required. In addition, the firm is designing the 3-car center, side, and elevated platforms. Station amenities include canopies, benches, ticket vending machines, variable message signs, public address speakers, closed circuit television cameras, lighting, and tree wells. The firm is also responsible for designing the park-and-ride lots, a 1,500-car garage, and a 650-car garage, as well as planning and design for traction power, overhead contact, train control, and communications systems.

MBTA, Boston, Massachusetts, Former Superintendent of Transmission and Distribution.

Martin directed and coordinated all operating activities for the Transmission and Distribution Division. He was responsible for the maintenance of 100 miles of catenary, 13 miles of trolley bus, 1,300 miles of DC cable, and 300 miles of AC cable. Martin directed the performance, training, and discipline of 130 professional and trade personnel, including supervisors, engineers, linespeople, cable splicers, cable layers, equipment operators, and driver groundspeople. He also prepared the multimillion-dollar division budget and monitored expenditures. He administered contracts for asbestos abatement, Dig Safe Utility Marking, and high-voltage cable splicing. Martin served as project manager for two major catenary construction projects performed with MBTA personnel under force account — projects that both came in under budget and without any disruption to service. He monitored all work performed by contracts on catenary construction projects, including review and final decision of designs by consultants. In addition, Martin managed an engineering support group responsible for system wide design and maintenance of all catenary trolley bus transmission and distribution lines. He also served as a member of the Board of Directors of Dig Safe.

KAREN BRESLAWSKI, AIA

Stations Design Discipline Lead

Valuable Experience:

- ✓ Managed design teams for rail stations and facilities
- ✓ Experience working with the MBTA
- ✓ Coordination with design build teams
- ✓ Public involvement

Years of Experience

35

Education:

M.S., Architecture, State University of New York, Buffalo

B.A., Professional Studies in Architecture, State University of New York, Buffalo

Professional License/ Certification:

Registered Architect, Massachusetts
National Council of Architectural Registration
Boards

Karen is a Senior Architect with more than 30 years of experience in the planning, design, and development of transportation facilities for public agencies throughout Massachusetts. She has a successful record of accomplishments in the transit market with projects that include feasibility studies, task orders, and large-scale endeavors for clients including the MBTA and MassDOT. She has successfully managed designs for new rail stations, station renovations, and bus stations and intermodal transportation centers, overseeing station elements including platforms and canopies; pedestrian circulation around stairs, elevators, and enclosed bridges; signage and lighting; and track rearrangement. She has proven skill in coordinating with multidisciplinary teams to maintain quality from the study phase through construction administration. Karen also has experience making presentations at town meetings and committees.

DESCRIPTION OF COMPARABLE PROJECTS

NB Development Group, Boston Landing Station, Brighton, Massachusetts, Senior Architect. Karen oversaw the development of final architectural plans and provided construction administration for the new \$26 million commuter rail station located adjacent to the New Balance headquarters in Brighton. The project elements include track rearrangement; platforms and canopies; pedestrian circulation around stairs, elevators, and enclosed bridges; and signage and lighting. The project was built through a construction manager-at-risk delivery method and was the first in Massachusetts to be built through a public-private partnership with the MBTA.

MassDOT, Longfellow Bridge Rehabilitation Design Build, Boston and Cambridge, Massachusetts, Architect. Karen was responsible for providing technical support for architectural aspects of this \$255 million design build rehabilitation of the Longfellow Bridge, a 2,135-foot structure that carries Route 3 and the MBTA's Red Line over the Charles River between Boston and

Cambridge. Karen led the review of the architectural design drawings and performed QC checking for the architectural portions of the project, which include railings, decorative elements, and the bridge's signature granite towers that are to be dismantled and restored.

MBTA, Wellington Carhouse Expansion and Improvements, Medford, Massachusetts, Project Manager. Karen was responsible for providing construction-phase services for the MBTA's \$75 million expansion of the Wellington Carhouse. The agency is expanding the facility to accommodate 152 new Orange Line cars that will eventually replace the current fleet of 120 cars. As Project Manager, Karen was responsible for coordinating a team of architects and engineers that developed final plans for a 12,000-sf single-bay addition to the east side of the 40-year-old building. Her design role entailed analyses of the facility's as-built conditions to determine programming based on staff and equipment space needs, as well as cost effectiveness. Karen provided bid-phase support and assisted the MBTA with selecting a general contractor. During construction, she is responding to RFIs, reviewing shops drawings, and conducting site inspections, as needed.

MBTA, Hingham Intermodal Center, Hingham, Massachusetts, Technical Advisor. Karen conducted QA/QC reviews for the design of a \$6.4 million intermodal transportation facility. The 8,400-sf facility is a terminal building for both bus and commuter boat operations, and it provides office space for the Hingham Harbormaster, the Massachusetts Department of Conservation and Recreation's Harbor Islands staff, MBTA Operations staff and ticket sales, and the Massachusetts Environmental Police. The facility was designed to LEED® Gold standards and incorporates a green roof, geothermal heat exchange system, passive ventilation, rapidly renewable materials, regional materials, low emitting materials, daylighting, sun shading devices, and stormwater recharging. Karen reviewed the final design to verify that it met STV's standards and specifications. She also reviewed the proposed layout to determine whether it met applicable codes, including ADA and Massachusetts Architectural Access Board standards.

MassDOT, Central Artery DO11A, Boston, Massachusetts, Project Manager. Karen oversaw the architectural pieces of the tunnel finishes for this portion of the Central Artery/Tunnel Project in Boston. Karen coordinated wall tile layout and patterns, signage, railings, doors, exits, ceiling panels, and entries and exits with structural, civil, and mechanical/electrical elements for the \$450 million design-build project section, which is located between Kneeland Street and Congress Street in the heart of Boston.

ROBERT CONNORS, PE, CQM/OE, CQA, CCS, CCP NETTCP QAT

Design Quality Assurance/Quality Control Manager

Valuable Experience:

- ✓ MBTA
- ✓ Quality management plans
- ✓ Communication
- ✓ QA/QC

Years of Experience: 30

Education:

M.S., Finance; Suffolk University
M.S., Business Administration, Suffolk University
B.S., Civil Engineering; University of Rhode Island

Professional Licenses/ Certifications:

Professional Engineer, MA Civil #39185
Professional Engineer, MA Structural #38924
Certified Cost Professional, AACE #2966
Certified Construction Specifier, CSI
MasterFormat Accredited Instructor, CSI
Certified Management Accountant, IMA #962879
Certified Manager of Quality/Organizational Excellence, ASQ #13209
Certified Quality Auditor, ASQ #41100
Certified Quality Assurance Technologist, NETTCP

Robert is a Senior Quality Manager with more than 30 years of experience in engineering and project oversight for clients including the MBTA and MassDOT. With a varied project portfolio that includes rail, bridge, maintenance facilities, and stations, he has the credentials needed to tackle high-profile quality challenges involving large teams. Robert has extensive experience with design-build, including the MBTA Greenbush Line Rail Restoration Design Build, and public-private partnerships. A Certified Quality Manager and Certified Quality Auditor through the American Society of Quality, he provides quality management and oversight for national projects and serves as the quality manager in the Boston office. His experience with inspection, design, specifications, construction materials testing, project management, construction cost estimating, cost accounting, scheduling, claims analysis, finance, and contract administration allows him to find optimum solutions to quality issues on large complex projects.

DESCRIPTION OF COMPARABLE PROJECTS

MassDOT, Longfellow Bridge Rehabilitation Design Build, Boston and Cambridge, Massachusetts, Quality Administrator. Robert is directing the QC team in the preparation and administration of the design and construction quality plans for the \$255 million design build rehabilitation of the Longfellow Bridge. The 2,135-foot structure, constructed in 1908, carries Route 3 and MBTA Red Line tracks over the Charles River between Boston and Cambridge. Robert prepared quality management plans, trained project personnel on

the plans, implemented the plans, audited performance, and implemented quality improvements for design and construction. The design phase is complete and the firm is providing construction support services for the contractor.

City of Ottawa, Confederation Line LRT, Ottawa, Ontario, Canada, Quality Control/Procurement Manager. Robert performed QC and prepared bridging documents as part of the procurement team for this \$2.1 billion public-private partnership. Project is constructing a 7.8-mile electric line from Tunney's Pasture Station in the west to Blair Station in the east via a downtown transit tunnel. Robert reviewed all components of the proposed project, including 13 stations, four of which are in a tunnel under downtown Ottawa between Bronson Avenue and the University of Ottawa. The remaining nine stations are located at-grade within the existing transitway corridor. A new 26.3-acre vehicle maintenance and storage facility supports the new line. The owner is the City of Ottawa and the system will be operated by OC Transpo.

WRTA, Bus Maintenance, Operations, and Storage Facility, Worcester, Massachusetts, QC Manager. Robert prepared the quality plan, trained to the plan, managed quality audits, and provided QC oversight for the design of a new vehicle maintenance, operations, and storage facility for the Worcester Regional Transit Authority (WRTA). The \$75 million, 2-story, 150,000-sf facility will have a capacity to store and maintain 80 vehicles and space for 155 employees.

Metropolitan Washington Airport Authority, Dulles Corridor Metro Rail Phase 2 Project, Fairfax County, Virginia, External Quality Auditor. Robert performed FTA based quality auditing and related quality work for the Dulles Metrorail Project Management Procedures. This \$2 billion, design-build, metro extension includes six stations along 11.4 miles from the Wiehle-Reston East Station to Ashburn.

LIRR/MTA, East Side Access, New York, New York, External Quality Auditor. Robert performed quality auditing and related quality work for an FTA based audit of the General Engineering Consultant for this \$10.8 billion project. Extending between Sunnyside, Queens, and Grand Central, the project will route the LIRR from its Main Line through new track connections in Sunnyside Yard and through the lower level of the existing 63rd Street Tunnel under the East River. In Manhattan, a new tunnel will begin at the western end of the 63rd Street Tunnel at Second Avenue, curving south under Park Avenue and entering a new LIRR terminal beneath Grand Central Station.

NEAL DEPASQUALE

VMF Design Discipline Lead

Valuable Experience:

- ✓ Design teams
- ✓ Construction teams
- ✓ MBTA
- ✓ Start-up, testing, and commissioning

Years of Experience: 38

Education: B.S., Architectural Engineering; Wentworth College of Technology

Professional License/Certification: Massachusetts Certified Public Purchasing Official (MCPPO), Certification for School Project Designers and Owner's Project Managers

Neal is a Senior Project Manager with more than 35 years of experience supervising the study, design, and construction of various transportation and industrial projects for clients including the MBTA and MassDOT. He has overseen projects from conceptual stages through construction management that encompass all architectural and engineering disciplines. Neal's responsibilities during construction have included shop drawing documentation control and review, response to contractors' requests for information, evaluation of change order requests, periodic site inspections, revision of designs to accommodate for unforeseen site conditions encountered during construction, and interpretation of contract documents. He has also performed reviews at substantial completion, developed punch list items, participated in the startup and testing of equipment, and conducted final inspections.

DESCRIPTION OF COMPARABLE PROJECTS

Amtrak, ARRA CM Services Southampton Yard, Boston, Massachusetts, On-Site Quality Control Engineer/Closeout Documentation. Neal provided QC services for \$22 million in rail yard and maintenance facility improvements for this design build project at Southampton Yard. Subsequent to the firm's completion of a feasibility study at Southampton Yard, Amtrak retained the firm as a subconsultant to a major consulting firm to prepare design build bridging documents and oversee construction. The project, which was funded through the American Reinvestment and Recovery Act of 2009, involved several separate design and contract packages, including the addition of a drop-table building and equipment to the existing high-speed rail building; complete rehabilitation of the existing train washer, including installation of spray arches, brushes, strippers, integrated train sensor systems, electrical power and controls, and interconnecting plumbing and pump systems; and a new building addition to house reclamation and filtering tanks and controls. Neal's role included daily inspections of the work during day, night, and weekend work shifts to ensure that the work adhered to safety requirements and design documents, specifications, and approved shop drawings.

Amtrak, Northeast Corridor Acela High-Speed Rail Maintenance Facilities Design-Build, Boston, Massachusetts and Queens, New York, Assistant Project Manager. Neal was responsible for overseeing the civil/site and utility design at the Southampton Yard in Boston and Sunnyside Yard in Queens, as part of this \$112 million design build contract. His tasks included coordination with public and private utility agencies and companies; identifying building and environmental permit requirements, including their priority and approval duration; pedestrian and vehicular site circulation issues; and interfacing with surrounding rail traffic and operations. His responsibilities also included design support during construction.

WRTA, Vehicle Maintenance, Operations, and Storage Facility, Worcester, Massachusetts, Project Manager. Neal oversaw design services for a new, \$75 million vehicle maintenance, operations, and storage facility for the Worcester Regional Transit Authority (WRTA). The 2-story, 150,000-sf facility has a capacity for 52 buses, 28 vans, and various nonrevenue vehicles, as well as space for 155 employees. Under his direction, the firm completed the Phase I – Program and Conceptual Design (15%), Phase II – Site Investigation and Analysis to advise the WRTA on the environmental impacts and costs of constructing the facility on the selected NStar site, and Phase III – 30% design to construct the new vehicle facility at the subject site. The firm then completed Phase IV – 100% final design, assisted WRTA and its project manager in the selection of a construction manager-at-risk in accordance with Massachusetts General Law Chapter 149A, and provided construction-phase services for the facility.

MBTA, Green Line Copley Station Accessibility Improvements, Boston, Massachusetts, Project Manager. Neal oversaw the design and administrative duties for \$20 million accessibility improvements and general renovation of historic underground Copley Station. Improvements included rehabilitation of historic head houses, raising station platforms by 8 inches to accommodate the MBTA's new low-floor vehicles, adding ADA-compliant elevators at station platforms, and installing CCTV systems. Emergency egress stairs, tactile warning strips along station platforms, pedestrian ramps and crosswalks, new unisex toilets, new fare collection system and booths, new electric rooms, and offices were also included in this project. Neal worked closely with these agencies to develop elaborate construction zones and traffic management plans in coordination with city officials and abutters. He provided day-to-day construction phase services, attended weekly meetings, responded to requests for information and change-order requests, reviewed shop drawings, and visited the site as needed to ensure that completed work matched the design.

ENNIO ELEUTERI, PE

Retaining Walls Design Discipline Lead

Valuable Experience:

- ✓ MBTA
- ✓ Structural design
- ✓ Coordinates engineering and construction

Years of Experience: 23

Education: M.S., Civil Engineering, Northeastern University
B.S., Civil Engineering, Northeastern University

**Professional License/
Certification:** Professional Structural Engineer:
MA, # EN41284-ST

Ennio is a structural engineer with more than 20 years of experience in design of various structural elements of roadways, bridges, and transit facilities for clients including the MBTA and MassDOT. He is a subject matter expert with regard to MassDOT standards and procedures, having worked on numerous contracts in cities and towns throughout Massachusetts. He has performed various types of structural analyses, including finite element analyses, time dependent analyses, and pre-stress/post-tension concrete analyses. Ennio is skilled in managing teams in the preparation of sketch plans and development of designs.

DESCRIPTION OF COMPARABLE PROJECTS

MBTA, Greenbush Line Rail Restoration Design-Build, Boston, Massachusetts, Lead Structures Engineer. Ennio performed and reviewed superstructure and substructure design calculations for 10 railroad and 8 highway bridge rehabilitations located along 18 miles in five communities during the \$320 million restoration of the Greenbush Line. Ennio coordinated multiple bridge designs with staff in multiple office locations. He assessed six prestressed concrete box beam bridges, designed or reviewed designs for substructure abutments, and performed construction phase services for the construction of steel and concrete bridges. Ennio also reviewed shop drawings and responded to requests for information for the MBTA project.

NB Development Group, Boston Landing Station, Boston, Massachusetts, QA/QC Reviewer. Ennio conducted a QA/QC review of structural designs for this new MBTA commuter rail station under construction adjacent to the New Balance corporate headquarters. The design includes a glass elevator, pedestrian bridge, stairs, a center island platform, and canopy.

MassDOT, Belden Bly Bridge, Lynn and Saugus, Massachusetts, Project Manager. Ennio is overseeing the replacement of the Belden Bly Bridge. The proposed replacement bridge, a heel-trunnion bascule bridge with a 70-foot span, will carry four lanes of roadway traffic and two pedestrian sidewalks over the Saugus River between Lynn and Saugus, MA. The project scope includes

two approach spans, 300 feet of new retaining wall, and approach roadway work. Ennio has coordinated all engineering disciplines, including civil, utility, mechanical, electrical, and structural. He has also served as the point of contact for MassDOT's project manager for all technical and contractual issues. Traffic is currently carried by a temporary movable bridge.

MassDOT, Fore River Bridge Replacement, Quincy and Weymouth, Massachusetts, Lead Structural Engineer. Ennio is providing construction-phase support for a new \$245 million vertical lift bridge. The 2,640-foot bridge will carry Route 3A over the Fore River. This project is part of MassDOT's Accelerated Bridge Program. The main span consists of a 324-foot vertical lift movable span over the Fore River that will provide a 250-foot navigation channel. Ennio prepared a sketch plan and 60% design development documents for the bridge. He managed multiple structural engineers in the design and detailing of the steel towers, steel truss lift span, foundation pier, cap, drilled shafts, and fender system. Additionally, Ennio coordinated architectural, mechanical, and electrical disciplines who contributed to the lift span design. He also reviewed the final design developed by the design-build team. During ongoing construction, he is involved with responding to RFIs, nonconformance reports, and other construction-related issues.

South Shore Tri-Town Development Corporation, East-West Parkway Design-Build, Abington, Weymouth, and Rockland, Massachusetts, Senior Structural Engineer. Ennio performed design reviews of bridges and retaining walls built along the eastern portion of the \$41 million East-West Parkway, which serves as the main artery for SouthField, a \$1.5 billion mixed-use village-style community at the former South Weymouth Naval Air Station. Ennio reviewed the design of bridges that cross two wetlands and the Old Swamp River, as well as the design of a mechanically stabilized earth retaining wall. He also verified that the designs met contract requirements, MassDOT Bridge Manual standards, and AASHTO criteria.

CATS, South Corridor Infrastructure Project, Charlotte, North Carolina, Structural Engineer. Ennio performed a structural review of contract documents for the proposed extension of the light rail for the Charlotte Area Transit System (CATS). The project entailed improvements to eight stations along 5 miles of the corridor to promote vehicular, pedestrian, and bike access to the future light rail stations. Ennio reviewed designs with the goal of reducing the overall construction cost of the project.

J. MARK ENNIS, PE, PMP

Deputy Design Manager Stations, Infrastructure, ROW

Valuable Experience:

- ✓ MBTA
- ✓ Manage design team
- ✓ Rail transit
- ✓ Community issues
- ✓ State and local agencies
- ✓ Construction impacts

Years of Experience: 29

Education: M.S., Civil Engineering; Old Dominion University
B.S., Civil Engineering; University College of Dublin

Professional License/Certification: Registered Professional Civil Engineer, Massachusetts

Mark has more than 25 years of varied experience involving new and rehabilitated bridge design, bridge confirmatory inspection and capacity ratings, retaining walls, and building design. He has overseen the design of numerous bridge types, including cable-stayed, vertical lift, bascule, truss, and arch bridges for highways and railroads. He is also experienced in stations, elevated structures and viaducts, tunnel structures, and tracks and signals; ADA compliance; regulatory agency permitting; and the coordination of community issues such as accessibility, safety, noise, and the mitigation of construction impacts. In addition, Mark is a project leader with a record of completing complex, multidisciplinary projects in accordance with quality, schedule, and budget objectives. His managerial responsibilities have included the overall administrative, contractual, financial, and technical leadership of transit and transportation projects, as well as interaction with public and private clients, supervision of subconsultants, and coordination with state and local agencies.

DESCRIPTION OF COMPARABLE PROJECTS

MBTA, Greenbush Line Rail Restoration Design Build, Braintree, Weymouth, Hingham, Cohasset, and Scituate, Massachusetts, Deputy Project Manager/Technical Coordinator. Mark oversaw the layout and design of 7 rail stations, 18 rail and highway bridges, 28 grade crossings, roadway intersections, 18 miles of track, and 2 railroad underpasses for this \$320 million design-build project to restore service on the Greenbush Commuter Rail Line. Mark designed and coordinated partial and full demolition of abandoned bridges along the 18-mile rail ROW. Other work included permitting, landscaping, noise mitigation, and signal and communications systems. His coordination responsibilities also included resolving comments and issues with the contractor, the MBTA, the Historic Conservator, the five towns through which the railroad passes, and several other reviewing and permitting agencies. Mark was also responsible for managing construction phase services.

MassDOT, Longfellow Bridge Rehabilitation Design Build, Boston and Cambridge, Massachusetts, Design Lead. Mark was responsible for the design of the \$255 million design-build project to restore what is considered to be the most historically significant bridge in Massachusetts. The 2,135-foot structure, constructed in 1908, carries Route 3 and MBTA Red Line tracks over the Charles River between Boston and Cambridge. It features ornate metal casting and masonry features, including four neoclassically inspired granite towers. Mark provided design oversight and obtained design approval from regulatory and public agencies, including MassDOT, FHWA, MBTA, Massachusetts Department of Conservation and Recreation, U.S. Coast Guard, the City of Boston, the City of Cambridge, the Massachusetts Department of Environmental Protection, and the Historic Review Board (Section 106). He provided ongoing support of public outreach efforts for his highly visible project, and was responsible for all aspects of the design, including the steel arch superstructure rehabilitation, deck system replacement to support both rail and roadway traffic, the masonry substructure strengthening, the masonry tower reconstruction, and the proposed signature pedestrian bridge that is to be located immediately adjacent to the bridge. The design phase is complete and the firm is providing construction support services for the contractor.

MassDOT, Fore River Bridge Replacement, Quincy and Weymouth, Massachusetts, Project Manager. Mark managed the design and permitting of the \$245 million replacement of the 2,640-foot crossing of Route 3A over the Fore River. This project is part of MassDOT's Accelerated Bridge Program. The main span consists of a vertical lift movable span over the Fore River navigation channel. The original bascule bridge was constructed in 1933 and was a significant feature along Massachusetts Bay. It was recorded for the Historic American Engineering Record in 1969 but deteriorated and was replaced by a temporary structure in 2002. Mark managed the preparation of estimates, type study reports, and sketch plans, as well as environmental permitting coordinated with MassDOT, the U.S. Coast Guard, and the Massachusetts Office of Coastal Zone Management. During the investigation of different structure types, he participated in 19 public presentations of the project over the course of 18 months to various stakeholders, including elected officials, state and federal agencies, mariners, and the public. Mark generated a set of design-build procurement documents on behalf of MassDOT. He also oversaw construction support services.

BRIAN FLAHERTY

Technical Advisor

Valuable Experience:

- ✓ Design build
- ✓ MBTA
- ✓ Design and construction efforts
- ✓ Light rail

Years of Experience: 46

Education: Coursework, Civil Engineering, Hofstra University

Brian, STV's Design Build National Practice Leader, has more than 40 years of experience in the engineering and construction industry. He has held positions ranging from field engineer and project manager to principal-in-charge. With industry-recognized experience and capabilities, Brian is known for creating a climate in which construction activities progress smoothly and for his excellent direction of all aspects of construction management and design build activities. An experienced project executive, he has considerable experience successfully directing projects for transportation and government agencies, maintaining control over all schedules, costs, and expenditures. Projects under his direction have encompassed the coordination of, and interface with, architectural and engineering designers, contractors, trade unions, transit operators, and rail vehicle manufacturers. Brian's innovative and award-winning assignments have included projects with varying construction costs up to \$10 billion.

DESCRIPTION OF COMPARABLE PROJECTS

MBTA, Greenbush Line Rail Restoration Design Build, Braintree, Weymouth, Hingham, Cohasset, and Scituate, Massachusetts, Constructability Coordinator. Brian served as Constructability Coordinator responsible for coordinating all design efforts and developing constructability reports for the 18-mile railroad rehabilitation project. The project scope consisted of the restoration and reconstruction of the largely out-of-service railroad right-of-way and included the implementation of seven new stations (each with an 800-foot-long high-level platform), a new signal and communication system, and a layover facility. The \$320 million MBTA project also included a modified shallow cut tunnel, which involved a complicated vertical alignment; an 800-foot cut-and-cover tunnel with 900-foot boat section approaches on each side; and off-line freight facilities.

MassDOT, Longfellow Bridge Rehabilitation Design Build, Boston and Cambridge, Massachusetts, Constructability Coordinator. Brian is serving as Constructability Coordinator responsible for coordinating all design efforts and developing constructability reports for this \$255 million design build rehabilitation of the Longfellow Bridge, a 2,135-foot structure that carries Route 3 and the MBTA's Red Line over the Charles River. As the lead designer, STV provided multidisciplinary design services for the bridge, as well as plans

for trackwork, traction power, communications, and signals for the Red Line. When complete, the bridge will be AASHTO compliant and ADA compliant. The design phase is complete and the firm is providing construction support services for the contractor.

MTA, Capital Construction/LIRR East Side Access, Queens, New York, Constructability Coordinator. Brian is serving as Constructability Coordinator responsible for coordinating all design efforts and preparing constructability reports for this \$10 billion project to provide tunnel engineering services, including planning, preliminary and final design engineering, and construction phase services to extend Long Island Rail Road (LIRR) service to Manhattan's East Side, terminating in Grand Central Terminal. Design elements include a new station in Sunnyside; rail maintenance facilities and yard; and new intermodal station and platform facilities within Grand Central Terminal.

NJ TRANSIT, Meadowlands Maintenance Complex, Kearny, New Jersey, Project Director. As Project Director for the construction phase, Brian directed the construction management of this major rail vehicle maintenance facility and yard. He was directly responsible for establishing the project procedures manuals, a QA/QC program, the project schedule, and a work breakdown structure to administer the budget for the duration of the project. He was also responsible for all resource allocations and for the review of project status reports, covering project progress, budget adherence, and schedule compliance. He served as the main point of contact between the client and the construction management team. The \$106.7 million complex incorporates state-of-the-art service equipment and machinery; industrial, mechanical and electrical systems for maintenance and operations functions; administrative/employee and storage facilities; traction power systems; and utility systems, covering drainage, water, supply, lighting, communications, ancillary power, and waste disposal. The facility is NJ TRANSIT's primary facility for rolling stock maintenance.

MICHAEL HEALEY, LCS, NETTCP QAT

Project Controls Manager

Valuable Experience:

- ✓ MBTA
- ✓ Project controls
- ✓ Design and construction

Years of Experience: 38

Education: B.S., Administration, University of Massachusetts at Amherst

**Professional Licenses/
Certifications:** Licensed Construction Supervisor (LCS), Massachusetts # CS- 063675
Certified Quality Assurance Technologist, NETTCP
Massachusetts Certified Public Purchasing
Official (MCPPO), Certification for School Project
Designers and Owner's Project Managers

Michael is a project controls expert and licensed construction supervisor (LCS) with considerable experience providing contractor oversight, document control, requests for information responses, change-order management, and QA/QC to the MBTA. He has served in various roles, including deputy project manager, director of project controls, and QA/QC manager for MBTA initiatives, such as the MBTA Greenbush Line Rail Restoration Design-Build. Michael is valued for his ability to coordinate all disciplines, including civil, structural, HVAC, plumbing, electrical, mechanical, and architectural. A well-rounded professional, Michael is also skilled in surveying, design, and resident inspection.

DESCRIPTION OF COMPARABLE PROJECTS

MBTA, Greenbush Line Rail Restoration Design-Build, Braintree, Weymouth, Hingham, Cohasset, and Scituate, Massachusetts, Director of Project Controls and QA/QC. Michael was responsible for all document control functions related to the submittal of more than 100 individual design packages, from preliminary to final design, for the \$320 million restoration of this 18-mile-long commuter rail line. This MBTA project encompassed 18 bridges (both railroad and highway), 7 new stations, 1 tunnel, 1 underpass, 7 at-grade parking facilities (200 to 1,000 spaces), access roads, retaining wall structures, and wetland delineation and permitting. Michael assumed the responsibilities of the outgoing Director of Project Controls. He directed project controls for shop drawings, subconsultant coordination, transmittal, and tracking and recovery of all documents via an Expedition database.

MassDOT, Longfellow Bridge Rehabilitation Design-Build, Boston and Cambridge, Massachusetts, Project Controls Manager/Assistant QC Manager. Michael tracked change orders and reviewed civil, structural, and traffic control designs for the \$255 million rehabilitation of this bridge over the

Charles River that carries Route 3 and the MBTA's Red Line between Boston and Cambridge. Michael tracked all project documentation, including cost and schedule records, and provided general maintenance of the firm's SharePoint database. His role involved evaluating contractor-initiated changes to the final design, identifying any changes that conflicted with engineering plans, and marking potential change orders that presented the risk of cost increases and schedule overruns. Michael compiled the information in a spreadsheet that was used to negotiate and resolve approximately 100 items with the design team, contractor, and client. Additionally, he provided QC reviews of various elements of design, such as the bridge structure, track, sidewalks, roadway, and traffic control plans. Michael's oversight involved peer reviews of design drawings to identify potential errors, such as miscalculations or cosmetic inadequacies.

MBTA, Green Line Copley Station Accessibility Improvements, Boston, Massachusetts, Deputy Project Manager. Michael oversaw the day-to-day design and administrative duties for this project to make the historic MBTA Copley Station, constructed in 1912, compliant with ADA guidelines. Michael ran meetings, wrote minutes, responded to RFIs and change-order requests, reviewed shop drawings, coordinated with subcontractors and the client, and visited the site to make sure work was completed according to design plans and specifications.

MBTA, Commuter Rail Maintenance Facility, Somerville, Massachusetts, Inspector. Michael conducted construction phase service site visits for coordination of disciplines, including HVAC, plumbing, industrial, structural, civil, trackwork, and survey of a series of buildings constructed to house locomotive and coach repair.

Amtrak, ARRA CM Services Southampton Yard, Boston, Massachusetts, Senior Resident Engineer. Michael provided on-site construction management for \$22 million in rail yard improvements at Southampton Yard in Boston. Subsequent to STV's completion of a feasibility study at Southampton, Amtrak retained the firm as a subconsultant to a major consulting firm to prepare design-build bridging documents and oversee construction. The project, which was funded through the American Reinvestment and Recovery Act of 2009, involved restoration of the existing rail facility, including train washer replacement, track improvements, roadway reconstruction, security upgrades, and utility improvements. Michael oversaw four other resident engineers/inspectors staffing this fast-track project and sometimes operated 7 days a week and 24 hours a day. He reviewed design-build submissions and performed QC inspection of all contractors' work to verify compliance with the approved plans and specifications.

JEROME MACKENZIE, PE

Structures Design Discipline Lead

Valuable Experience:

- ✓ Managing design teams
- ✓ Design build teams
- ✓ Construction techniques and staging
- ✓ MBTA

Years of Experience: 34

Education: B.S., Civil Engineering, Northeastern University

Professional License/Certification: Professional Structural Engineer: MA #34740-ST

Jerome has more than 30 years of experience as a structural engineer, possessing a strong management background for the design of fixed and movable bridge rehabilitation and replacement projects for clients including the MBTA and MassDOT. His areas of expertise include condition assessments; nondestructive inspection techniques; structural analysis; design and review of design calculations; construction inspection; prestressed concrete analysis; and preparation of contract drawings, specifications, and construction cost estimates. A National Bridge Inspection Standards (NBIS)-certified inspector, Jerome is highly knowledgeable of inspection standards for highway and railroad bridges. His projects have ranged from simple footprint replacements to complex structures, often involving elaborate construction techniques and staging. Jerome is a skilled project manager with a thorough understanding of how to complete projects that meet client quality objectives, schedules, and budgets. He is skilled at coordinating tasks among clients, subconsultants, and in-house engineers to bring together engineering documents from planning/permitting stages to final design/contract award.

DESCRIPTION OF COMPARABLE PROJECTS

MBTA, Greenbush Line Rail Restoration Design-Build, Braintree, Weymouth, Hingham, Cohasset, and Scituate, Massachusetts. Senior Structural Engineer. Jerome provided structural engineering services for the MBTA's restoration and reconstruction of this 18-mile-long railroad line on the South Shore of Massachusetts. The project involved reconstruction of the right-of-way, rehabilitation or replacement of 18 bridges (10 rail and 8 highway), and construction of 7 new stations (each with an 800-foot-long high-level platform), a new signal and communication system, and a layover facility at the end of the line in the Greenbush area of Scituate. Jerome reviewed the structural design for several rail bridges on this project.

MassDOT, Longfellow Bridge Rehabilitation Design-Build, Boston and Cambridge, Massachusetts, Lead Structural Design Engineer. Jerome oversaw teams of designers focused on the superstructure elements of the \$255 million rehabilitation of the Longfellow Bridge between Boston and

Cambridge. Constructed in 1908, the 2,135-foot bridge carries Route 3 and the Red Line over the Charles River. It has structural deficiencies and widespread deterioration of its ornate masonry and metal casting features. In managing the structural team, Jerome coordinated design efforts with a variety of disciplines such as electrical lighting engineers. During the ongoing construction, he is managing the shop drawing and change order review processes and providing general construction advice, especially as it relates to the fit-up of new bridge elements. Because of the bridge's historic value, Jerome is also working closely with consultants specializing in Section 106 of the National Historic Preservation Act of 1966 to verify that the bridge's original appearance is preserved.

DART, LRT Extensions Phase I & Phase II, Dallas, Texas, Lead Bridge Engineer. Jerome oversaw preliminary through final design for three light rail and three heavy rail bridges in the Northwest Corridor from Houston Street to Turtle Creek in Line Section NW-1A as part of this \$2.3 billion project to expand the Dallas Area Rapid Transit (DART) light rail transit system, extending it to points farther from Dallas and making it more comprehensive within the city.

Metro-North, PECK Drawbridge and Bridgeport Railroad Viaduct Rehabilitation, Bridgeport, Connecticut, Structural Design Engineer/Inspector. Jerome performed a bridge inspection for the \$45 million rehabilitation of the PECK Railroad Bridge. Originally constructed in 1903, the PECK Drawbridge is a vital connection on the New Haven Line and the larger Northeast Corridor between Boston and Washington, D.C. The project involved a comprehensive study; in-depth inspection; total design, including civil, structural, and track engineering; and construction support services for the award-winning replacement of the PECK Drawbridge and the 3,000-foot Bridgeport Railroad Viaduct. The viaduct runs through downtown Bridgeport, crossing four main streets and the Pequonnock River.

MassDOT, University Avenue Bridge Improvements, Lowell, Massachusetts, Project Manager. Jerome managed the design and construction phases for the replacement of this historic steel deck truss bridge over the Merrimack River. The \$36 million MassDOT project included the demolition and removal of the existing 3-span structure and the construction of a new 520-foot bridge. The superstructure is composed of two continuous spans of deck trusses that are supported by new abutments and a new pier constructed in the middle of the Merrimack River. The project also involved upgrading traffic signal equipment and revising intersection geometry at the Pawtucket Street and University Avenue and V.F.W. Parkway and University Avenue intersections.

CHRISTOPHER R. MCDERMOTT, PE, LSP

Environmental Manager

Valuable Experience:

- ✓ Licensed Site Professional Services
- ✓ Soil Characterization for Disposal
- ✓ Groundwater Characterization & NPDES RGP Permitting & Treatment
- ✓ Soil and Groundwater Remediation Design
- ✓ Contaminated Soil and Groundwater Management

Years of Experience: 22

Education:

B.S., Engineering Sciences, Washington University, St. Louis, MO Christopher

B.S., Applied Math and Physics, Providence College

**Professional Licenses/
Certifications:** Licensed Site Professional, MA # 1955
Professional Engineer, MA # 48272

Christopher has more than 20 years of experience providing environmental engineering and Licensed Site Professional (LSP) services to large infrastructure and transportation projects in Massachusetts. Over the course of his career, he has worked on virtually all of the major stations, facilities, and yards within the MBTA system. He has excellent working relationships with the MBTA Environmental Department, as well as other departments at the MBTA, including Design and Construction, Operations, Budget, Safety, and Contract Administration. Christopher is experienced in collecting data, evaluating current and future risk, and designing a creative and cost-effective strategy for compliance and site closure under the Massachusetts Contingency Plan (MCP). He takes full advantage of MCP exemptions and policy to bring sites to closure.

DESCRIPTION OF COMPARABLE PROJECTS

MassDOT, Longfellow Bridge Rehabilitation Design-Build, Boston and Cambridge, Massachusetts, LSP. Christopher managed the characterization of contaminated soil and all hazardous materials on the bridge, the MBTA Red Line right-of-way, the piers, towers and abutments, the Storrow Drive pedestrian walkway, and associated subsurface soil in the area. The 2,135-foot structure, constructed in 1908, carries Route 3 and MBTA Red Line tracks over the Charles River between Boston and Cambridge. Christopher directed development of soil and hazardous materials management plans to enable cost-effective and timely construction.

WRTA, Vehicle Maintenance, Operations, and Storage Facility, Worcester, Massachusetts, LSP. Christopher directed extensive pre-construction characterization, developed plans, specifications, and cost estimates for soil remediation and a vapor barrier for the Worcester Regional Transit Authority (WRTA)'s new vehicle maintenance facility, prepared Construction Release Action Measure (RAM) and multiple MCP deliverables, and directed the oversight of contaminated materials management, on-site soil remediation,

environmental permitting, and monitoring of work zone and perimeter air quality for contaminated dust and asbestos fibers. He coordinated directly with MassDEP regarding soil remediation efforts and discovery of asbestos in fill. Christopher obtained quotes and coordinating off-site disposal of 70,000 tons of contaminated soil and petroleum/coal tar liquids.

Bosfuel Corporation, MCP Compliance and Environmental Management during Pipeline Construction at Logan Airport, Boston, Massachusetts, LSP-of-Record/Project Manager. Christopher provided environmental investigation, remediation design, construction oversight and MCP compliance in support of Bosfuel's \$50 million replacement of a portion of Logan's Fuel Delivery System (FDS). TRC collected subsurface data on soil, groundwater, and light non-aqueous phase liquid (LNAPL) and prepared an Immediate Response Action (IRA) Plan, Phase I – Initial Site Investigation & Tier Classification and multiple IRA Status Reports for a new reportable condition. TRC prepared a RAM Plan and NPDES Remediation General Permit and managed over 20,000 cubic yards of impacted soil as well as contaminated groundwater and LNAPL during construction. Christopher coordinated MCP compliance issues with other airport stakeholders, including Massport.

MBTA, On-Call Environmental Services Contract, Boston, Massachusetts, Project Manager/LSP. Christopher provided environmental engineering and LSP services on several task orders, including the Durante Wetlands Mitigation remedial cost estimation, evaluation of groundwater remediation at Cabot Yard and a wide variety of environmental staff training.

MBTA, Wellington Carhouse Expansion and Improvements, Medford, Massachusetts, LSP/Senior Engineer. Christopher performed the assessment of contaminated soil and hazardous building materials during the carhouse renovation. He provided plans and specifications for environmental design portion of 30%, 60%, 90%, and 100% Final Design contract documents, as well as input to cost estimation and construction scheduling. He recently directed the disposal pre-characterization efforts for roughly 20,000 cubic yards of soil to be excavated during construction.

MBTA, 12 Bridges Replacement Project, Boston, Massachusetts, Senior Engineer/LSP. Christopher directed the due diligence hazardous materials assessment of multiple bridges, as well as the evaluation of hazardous materials, including asbestos and lead-based paint, in existing bridge structures.

THOMAS O'HARA

Deputy Design Manager Operations, Systems, and VMF

Valuable Experience:

- ✓ MBTA
- ✓ Rail transit
- ✓ Power systems
- ✓ Power facility operations
- ✓ Infrastructure improvements
- ✓ Design disciplines and construction teams

Years of Experience: 34

Education: Coursework, Business Management; Quincy Junior College

**Professional Licenses/
Certifications:** Journeyman Electrician, Massachusetts Right-of-Way Training, Massachusetts Bay Transportation Authority

Thomas is an expert in transit operations and rail power systems who led the MBTA's Power Division for almost eight years. He has overseen the commissioning of new traction power substations, installation of OCS for the Silver Line, the AC cable replacement program, SCADA systems, and mobile substations, and is intimately familiar with MBTA operations, having directed and supervised the maintenance of local power systems, equipment, and transmission and distribution areas. In his former MBTA role, Thomas managed multiple capital improvement projects and participated in the negotiations of a 5-year, all-requirements power contract to purchase electricity for the agency. He and his Power Department were integral to previous Green Line projects including North Station and Riverside Station. He also successfully terminated rail services on the Mattapan High-Speed Line for complete restoration of the power systems.

DESCRIPTION OF COMPARABLE PROJECTS

MBTA, Wellington Carhouse Expansion and Improvements, Medford, Massachusetts, Traction Power Specialist. Thomas coordinated with multiple disciplines to design the stinger trolley system for the expansion and renovation of the 120,000-sf Wellington Carhouse maintenance facility. The renovation will allow the MBTA to accommodate 152 new Orange Line cars scheduled to replace the current fleet of 120. The stinger system is needed to facilitate the installation of new traction power equipment while the existing feeds power to the stinger trolley bugs. The existing carhouse power receptacles are not functioning and new equipment will be installed in the pit areas.

MassDOT, Longfellow Bridge Rehabilitation Design Build, Boston and Cambridge, Massachusetts, Systems Lead. Thomas coordinated with all the different disciplines to design the rail systems for MassDOT's rehabilitation of the Longfellow Bridge Project, which carries Route 3 and the MBTA's Red Line between Boston and Cambridge. The design, which incorporates the

communication, signal, track, and traction power systems into one package, has been staged so service can be maintained during construction. Thomas has also introduced a vital serial link for the signal system, which the MBTA approved. The design phase is complete and the firm is providing construction support services for the contractor.

MBTA, Orange Line Traction Power Upgrades, Boston, Massachusetts, Project Manager. Providing construction-phase support during the ongoing upgrade of the traction power substations located at the Sullivan, Wellington, Malden, and Oak Grove stations north of Boston. Thomas has provided design, QA/QC, scheduling, and budget services for the project, which involves the comprehensive replacement of outdated AC and DC equipment originally installed in the 1970s that have reached the end of their life cycles. The \$31 million project involves installation of 13.8-kV switchgear, station service auxiliary transformers, traction power transformers, DC switchgear, a cathode buss duct, the negative drainage board, SCADA and 1-on-1 supervisory control cabinets; and STB cabinets.

HMLP, Stray Current Testing and Evaluation, Boston, Massachusetts, Project Manager. Thomas oversaw the monitoring and evaluation of stray current within an area of the MBTA's Greenbush Line on behalf of Hingham Municipal Light & Power (HMLP). HMLP maintains seven utility poles within a 3,100-foot easement owned by the authority that have the potential to produce stray current and damage signal and communications equipment.

MBTA, Operations Support GEC, Various Locations, Massachusetts, Project Manager. Thomas managed an on-call team of professional consultants that assisted with the maintenance of tracks, stations, vehicles, and maintenance facilities. The contract included a Control Center Power Load Study and Electrical Distribution Equipment Condition Assessment and Elevator and Escalator Specifications for Maintenance and Repair, among other tasks.

ROBERT J. PALERMO, PE

Geotechnical Design Discipline Lead

Valuable Experience:

- ✓ Deep Foundations for Bridges/Viaducts
- ✓ Retaining Wall Design
- ✓ Instrumentation and Monitoring
- ✓ Subsurface Explorations
- ✓ Seismic Design
- ✓ LRFD
- ✓ Lateral Earth Support
- ✓ Ground Improvement
- ✓ Extensive design build experience

Years of Experience: 44

Education: B.S., Civil Engineering, Northeastern University
M.S. Studies, Massachusetts Institute of Technology

Professional License/Certification: Professional Engineer, MA No. 32053

Robert is a Senior Principal at GZA and has more than 40 years of experience in all aspects of geotechnical engineering and underground construction on bridge and transit projects in the U.S. and Canada, including: soil and rock mechanics, shallow and deep foundation engineering, seismic design, underpinning, instrumentation and monitoring, ground improvement, construction dewatering, and lateral support systems.

He has worked on over 150 bridges throughout the country ranging in size from \$5 million to the recently completed \$3.9 billion Tappan Zee Bridge Replacement Design-Build, which received several industry awards for its foundation design. Having worked on more than 100 bridge projects for MassDOT and the MBTA, he is knowledgeable of the GLX project design requirements and the local ground conditions.

Robert also served as the lead geotechnical engineer on transit projects such as the Bowdoin-Charles Connector, North Station Transportation Improvement Project, TD Garden, Green/Blue and Orange Line Tunnel Rehabilitation for the MBTA, and the recently completed 1st phase of the Second Avenue Subway project, and as the contractors engineer on the New Haven-Hartford-Springfield Amtrak project.

He has worked on several large design-build and P3 projects throughout the U.S. Robert has presented on foundation design at Transportation Research Board, The MOLES, Deep Foundations Institute, and the American Society of Civil Engineers.

DESCRIPTION OF COMPARABLE PROJECTS

NY State Freeway Authority, Tappan Zee Hudson River Crossing Design-Build, Tarrytown/South Nyack, New York, Lead Geotechnical Engineer. This Design-Build project consisted of the design and construction of two new 3-mile-long multiple span structures that carry I-87/287 across the Hudson River between Rockland and Westchester Counties. Robert was

responsible for the foundation design performed during the Tender Design phase, as well as the subsurface explorations, pile load testing program, and engineering analyses performed during the final design phase. Other services included quality control for pile and drilled shaft installation and environmental consulting. GZA's foundation design resulted in significant cost savings to the owner and the Fluor-led team.

MassDOT/MBTA, Multiple Bridges, Various Locations, Massachusetts, Lead Geotechnical Engineer/Senior Technical Reviewer. Robert has served as the Lead Geotechnical Engineer/Senior Technical Reviewer on more than 100 replacement or rehabilitation bridge projects, some of which included use of accelerated bridge construction methods. Projects include: Webster Street over Middle River, Worcester; Revere Beach Parkway over B&M Railroad, Revere; I-495 Bridges (Taylor Street, Route 2, and B&M Railroad), Littleton; I-95 (Rt 128) Add-A-Lane, Needham to Wellesley; Lagoon Pond Bridge, Martha's Vineyard; River Street and Western Avenue Bridges over Charles River, North Washington Street Bridge, Boston, Water Street, Danvers, and the Gloucester Drawbridge and Savin Hill Underpass for the MBTA.

Amtrak, Hartford Line, Various locations, Connecticut and Massachusetts, Lead Geotechnical Engineer. The project consisted of the widening of the existing railroad alignment to accommodate an additional track for high speed service between Springfield and New Haven. GZA redesigned more than 8,000 lf of retaining wall to support Cooper E80 train loads as value engineering for the contractor, Middlesex Corporation. The redesign resulted in significant schedule and cost savings to the owner and the contractor.

MBTA/Delaware North, TD Garden, Boston, Massachusetts, Lead Geotechnical Engineer. Robert designed rock socketed caissons, load bearing elements, and lateral support walls for a new facility with 5 levels of below grade parking. He was responsible for oversight of field engineers present on site during construction of over 200, 2.5- to 8-foot diameter, polymer slurry stabilized caissons and over 1,100 lf of reinforced concrete bentonite stabilized slurry walls. Robert reviewed instrumentation monitoring data during top-down construction activities for the 60-foot-deep excavation into clay/till/rock. He also performed environmental site investigation programs to evaluate the quality of soil and groundwater with regard to any impact on soil and groundwater handling and disposal techniques during construction.

MARK W. PELLETIER, PE

Design Manager



Valuable Experience:

- ✓ Experience working with the MBTA
- ✓ Local knowledge
- ✓ Experience managing large design teams
- ✓ Extensive rail transit experience
- ✓ Systems integration
- ✓ Start-up, testing, and commissioning experience
- ✓ Coordination with design build teams

Years of Experience: 34
Education: B.S., Civil Engineering; University of Massachusetts
Professional Licenses/ Certifications: Professional Civil Engineer: MA #34750
Professional Structural Engineer: MA #37343

Mark has spent the better part of his 34-year career at STV helping improve service for MBTA customers, particularly along the Green Line. He has overseen the North Station Transportation Improvement, Green Line Light Rail Accessibility Program, and Copley Station Accessibility Improvements, all of which were complex, multidisciplinary efforts that helped make the nation's busiest light rail system better. Mark is well-versed in all facets of engineering, including feasibility studies, design, permitting, and construction staging, but his greatest skill is his ability to communicate client goals to stakeholders and design teams. This quality made him well-suited to serve as design manager for the Greenbush Line Rail Restoration Design-Build, a challenging, 5-year assignment requiring day-to-day oversight of 100 design professionals and 15 subconsultant firms. Mark's on-site leadership was integral to Greenbush's 2007 launch and helped win STV the 2010 Gold Award for professional design excellence from the American Council of Engineering Companies of Massachusetts. He will commit to the same level of dedication for the duration of the Project.

DESCRIPTION OF COMPARABLE PROJECTS

MBTA, Greenbush Line Rail Restoration Design Build, Braintree, Weymouth, Hingham, Cohasset, and Scituate, Massachusetts, Design Manager. Mark oversaw the \$320 million complete design, including engineering services and management of all design consultants, for the reconstruction of the out-of-service railroad ROW. He led the design for the 18-mile ROW construction and oversaw the design for a five-legged roundabout, the rehabilitation of 10 railroad bridges, and eight highway bridges, including substructure and superstructure replacement, as well as seven stations and 28 grade crossings.

MassDOT, Longfellow Bridge Rehabilitation Design Build, Boston and Cambridge, Massachusetts, Principal-in-charge. Mark is overseeing the \$255 million design build effort to rehabilitate the Longfellow Bridge, a 2,135-foot structure that carries Route 3 and the MBTA's Red Line over the Charles River. As the lead designer, STV provided multidisciplinary design

services for the bridge, as well as plans for trackwork, traction power, communications, and signals for the Red Line. When complete, the bridge will be AASHTO compliant and ADA compliant. The design phase is complete and the firm is providing construction support services for the contractor.

MassDOT, Fore River Bridge Replacement Design-Build, Quincy and Weymouth, Massachusetts, Project Manager/Principal-in-Charge.

Mark was responsible for the alternatives analysis, permitting, achievement of 60% design, and preparation of bridging documents for design-build procurement for the \$245-million vertical-lift bridge of Route 3A over the Fore River. He is currently overseeing construction-phase services and design peer reviews on behalf of MassDOT.

MBTA, Wellington Carhouse Expansion and Improvements, Medford, Massachusetts, Principal-in-Charge. Mark oversaw the design development and final design services for the MBTA's \$80 million expansion of the Wellington Carhouse. The firm designed a 12,000-sf single-bay addition to the east side of the building, as well as upgrades to safety and security, and the MEP/fire protection systems.

WRTA, Bus Maintenance, Operations, and Storage Facility, Worcester, Massachusetts, Principal-in-Charge. Mark oversaw the design and construction of a two-story, 150,000 sf operations and maintenance facility for the Worcester Regional Transit Authority (WRTA). The firm provided architectural, structural, MEP, fire protection, industrial, traffic, and civil design services for the \$75-million facility. STV also assisted WRTA and their owner's project manager with the RFQ preparation and selection process to secure a CMR for this project, in accordance with Massachusetts General Law Chapter 149A.

MBTA, Green Line Copley Station Accessibility Improvements, Boston, Massachusetts, Project Manager/Project Director. Mark directed the \$20 million accessibility improvements and general renovation of historic underground Copley Station. The improvements included rehabilitation of historic head houses, raising station platforms by 8 inches to accommodate the MBTA's new low-floor vehicles, adding ADA-compliant elevators at station platforms, and installing CCTV systems.

ERIC ROOT, PE

Systems Design Discipline Lead

Valuable Experience:

- ✓ Traction power designs and analyses for LRT
- ✓ MassDOT
- ✓ Systems integration
- ✓ Start-up and testing

Years of Experience: 27

Education: B.S., Electrical Engineering; Virginia Polytechnic Institute and State University

Professional License/Certification: Professional Engineer, VT Electrical #018.0107605

Eric is an electrical engineer with more than 25 years of experience involving transportation, utility, and power generation projects. His expertise includes systems project management, electric power systems, system start-up, interfaces for light rail transit and commuter systems, and controller design for clients including MassDOT. Eric also has experience with voltage analysis and simulations, value engineering, and construction inspection and management. Additionally, he has frequently served as systems manager and traction power engineer for new transit systems in major metropolitan areas throughout the United States and Canada.

DESCRIPTION OF COMPARABLE

City of Ottawa, Confederation Line LRT, Ottawa, Ontario, Canada,

Traction Power Engineer. Eric completed the initial traction power design and analysis for the \$2.1 billion project to transform an exclusive, fully built-out bus rapid transit system into a light rail transit network – the first such conversion in North America. Eric provided preliminary design for a 1,500-VDC system, instead of a 750-VDC system, to accommodate the required vehicle consists and headways. The line will extend 7.8 miles, linking the neighborhoods of Tunney’s Pasture and Blair Station.

Region of Waterloo, Rapid Transit Division ION LRT System, Ontario,

Canada, Systems Manager. Eric is providing engineering services for the \$818 million ION LRT system for the Region of Waterloo Rapid Transit Division. The 11.8-mile (19-km) network will operate 14 light rail vehicles across 22 stations. Eric is responsible for managing the systems design for the design-build light rail project, including train control, traction power, OCS, and communications. He is coordinating the interfaces between the systems element with the civil, track, and station design leads and working with vendors to achieve a project agreement that is compliant and functionally correct.

MassDOT, Longfellow Bridge Rehabilitation Design Build, Boston and Cambridge, Massachusetts, Traction Power Engineer.

Eric was responsible for both train control and traction power for this \$255 million design build

rehabilitation of the Longfellow Bridge, a 2,135-foot structure that carries Route 3 and the MBTA's Red Line over the Charles River. As the lead designer, STV provided multidisciplinary services for the bridge, as well as plans for trackwork, traction power, communications, and signals for the Red Line. When complete, the bridge will be AASHTO compliant and ADA compliant. The design phase is complete and the firm is providing construction support services for the contractor.

Metro East, San Fernando Valley Transit Corridor, Los Angeles, California, Systems/Traction Power Design Lead. Eric led rail systems and traction power design for proposed improvements to transit service and regional connections through the heart of Los Angeles's San Fernando Valley along Van Nuys Boulevard and San Fernando Road. Key alternatives being studied for the Los Angeles County Metropolitan Transportation Authority (Metro) include LRT, bus rapid transit, and streetcar modes. Eric's responsibilities included helping to locate traction power substations for the purposes of environmental clearance.

CATS, LYNX Blue Line Extension Light Rail Project, Charlotte, North Carolina, Systems Manager/Traction Power Engineer. Eric was responsible for performing systems management for preliminary and final engineering services for the 9.3-mile Blue Line Extension for the Charlotte Area Transit System (CATS). The extension will run from Center City Charlotte northeast to the University of North Carolina at Charlotte. Eric managed various systems, including train control, communications, traction power, and the overhead contact system. He was responsible for the sizing and location of traction power substations, and developed traction power technical reports and design criteria. Eric also performed computer-based load flow simulations to determine voltage drop and verification of substation locations. In addition, he led the integration of the systems design package with the civil and station finish design packages.

MassDOT, Red/Blue Line Connector, Boston, Massachusetts, Lead Systems Engineer. Eric performed load flow simulation for a proposed MassDOT project to extend the MBTA Blue Line 1,500 feet on the Bowdoin end while eliminating the existing Bowdoin Station and adding a new Charles/MGH Station. Eric's simulation also included installation of a new traction power substation and removal of an existing feeder from North Substation. The load flow simulation verified that the design met the operation criteria of 6-car trains running at 4-minute headways at crush load.

PAUL TYRELL, PE, PLS, LEED AP BD+C

Road & Right-of-Way/Grading Design Discipline Lead

Valuable Experience:

- ✓ MBTA
- ✓ Civil design elements
- ✓ Design/construction teams
- ✓ Rail transit

Years of Experience: 31

Education: B.S., Civil Engineering; Wentworth Institute of Technology

**Professional Licenses/
Certifications:** Registered Professional Civil Engineer, Massachusetts
Professional Land Surveyor, Massachusetts
LEED Accredited Professional

Paul is an accomplished professional engineer and land surveyor with technical expertise in boundary and subdivision control law, easements and property rights issues, environmental permitting, hydraulics and hydrology, and trenchless technologies. Paul has worked in both the field and the office preparing designs and overseeing construction of a wide variety of projects, including bridge, highway, and railroad designs; synthetic and natural turf field installations; and commercial and residential developments. He has prepared construction documents for a variety of project delivery methods, including design-build, bid-build, and private solicitation. As a senior civil engineer, he contributed greatly to the success of the Greenbush Line by assuming responsibility for 130 design packages requiring inventory, evaluation, relocation, and protection of more than 250 different utilities along the 18-mile alignment.

DESCRIPTION OF COMPARABLE PROJECTS

MBTA, Greenbush Line Rail Restoration Design-Build, Braintree, Weymouth, Hingham, Cohasset, and Scituate, Massachusetts, Senior Civil Engineer. Paul designed all required project utilities and utility relocations for the \$320 million, 18-mile long reconstruction of the out-of-service railroad ROW. Paul oversaw preparation of more than 130 design packages with multiple submissions. He managed all utility design; was responsible for inventory, evaluation, relocation, and protection of more than 250 different utilities along the proposed alignment; and coordinated with the design-build contractor and numerous public and private agencies.

MassDOT, Longfellow Bridge Rehabilitation Design-Build, Boston and Cambridge, Massachusetts, Deputy Project Manager. Paul is responsible for coordinating design and construction for the \$255 million design-build rehabilitation of the Longfellow Bridge, a 2,135-foot structure that carries Route 3 and the MBTA's Red Line over the Charles River between Boston and Cambridge. The firm provided multidisciplinary design services for the

bridge and an adjacent pedestrian bridge, as well as plans for trackwork, traction power, communications, and signals for the Red Line. During the design phase, Paul coordinated design efforts for the entire design team including numerous subconsultants. He managed document control, design schedule, project submissions, and monitored QA/QC and permit compliance. The design phase is complete and the firm is providing construction support services for the contractor.

MBTA, Wellington Carhouse Expansion and Improvements, Medford, Massachusetts, Civil QA/QC Reviewer. Paul conducted a quality review and endorsed the final design submission for all civil components of the planned expansion and renovation of the Wellington Carhouse. The firm designed a 12,000-sf single-bay addition to the east side of the building and upgrades to safety, security, and the MEP/fire protection systems. Paul reviewed final designs and specifications for track alignment modifications within the carhouse and yard. He also reviewed final plans for relocating and installing site utilities and the dimensions of an adjacent access road the firm designed between the carhouse addition and the Wellington Station passenger station. After verifying the consistency, clarity, safety, and constructability of the plans, and their adherence with the project's official Quality Management Plan and MBTA standards, Paul authorized the design packages for bidding and construction.

Amtrak, ARRA CM Services Southampton Yard, Boston, Massachusetts, Owner's Representative. Paul provided design review services for \$22 million in improvements to the Southampton Rail Yard. Subsequent to STV's completion of a feasibility study at Southampton Yard, Amtrak retained the firm to prepare design-build bridging documents and oversee construction. The project involved complete restoration of the existing rail facility to include a new train washer, track improvements, roadway reconstruction, security upgrades, and utility improvements. Paul provided construction management (CM) services, including review of all design-build submissions and QC inspections of all contractors' works to verify compliance with the approved plans and specifications.

3.2 QUALITY MANAGEMENT PLAN

We have specifically developed our Quality Management Plan to complement the MBTA's Quality Management Plan, which is well known and understood by our team members. By taking an owner-operator perspective to quality management, GLX Constructors has an ISO 9001-compliant Quality Management Plan that is aligned with our Project Management Plan and incorporates our staff members' NETTCP and ASQ quality management certifications.

Our core belief in quality Project execution begins with the maxim: "Quality starts and stops with the individual."

Design Build (DB) construction is a highly integrated and fast-paced environment involving the activities of distinctly different disciplines, working separately and together, to complete a project in the fastest and most cost-effective manner. Therefore, an effective Quality Management Plan (QMP) is essential to involve the MBTA in our Quality Management System (QMS). Our QMP will empower the MBTA to oversee GLX Constructors' performance in design, construction, and commissioning of the Project. It will allow for seamless data handover at the end of the Project, enabling the MBTA to perform cost-effective asset management of the Green Line Extension DB Project.

Quality is of the highest importance and second only to safety. Similar to our approach to safety, we believe that every member of our team, from the top down, is responsible for confirming and delivering quality. Our prior experience developing, implementing, and administering comprehensive and successful quality programs will provide the basis for constructing a quality Project. Our presented data and daily information will prove our compliance with the MBTA's requirements, as well as the design specifications and drawings.

Our QMP will be ISO-9001 compliant, and it will meet the requirements of the U.S. Department of Transportation Quality Assurance (QA)/Quality Control (QC) Guidelines FTA-IT-90-5001-02.1. We will incorporate best practices and lessons learned from our extensive experience, which is derived from some of the United States' most complex infrastructure and rail projects.

GLX Constructors has primary responsibility for the overall QA and QC for the design and construction elements of the Project, including those performed by subcontractors, fabricators, suppliers, vendors, or agents. We will collaborate with the MBTA in developing our final QMP to incorporate the MBTA's quality requirements. This will lead to an optimized, Project-specific QMS that we can all support as a team.



GLX Constructors, including our Design Team and construction subcontractors, entrusts its DB Management Team and personnel to properly implement and document the QMP. We prioritize our responsibility for a quality Project, and we commit that we will document and fully comply with our QMP.

GLX Constructors' Quality Team is independent from the Construction Team. The Quality Team reports directly to the Project Executive, the Executive Committee, and the MBTA on the same reporting level as the Construction Manager. In this manner, the MBTA has immediate confirmation of quality concerns and approvals, providing confidence in the QMS and a close oversight of our quality performance.

Quality Assurance (QA), part of our QMP, incorporates management capabilities within the QMS that provide confidence our Project will meet or exceed requirements for the final, approved design plans and specifications. Our QMP will also identify the QC operational techniques and activities used to fulfill quality requirements.

We will develop our final QMP in concert with our final Project Management Plan (PMP). The QMP will be compliant with Federal Transit Administration's (FTA) QMS guidelines, and the MBTA's QMS. The QMP is the main document for developing and implementing our QMS. We will organize our QMP around the FTA's 15 essential elements of a QMS:

▶ Management Responsibility	▶ Product Identification and Traceability	▶ Non-conformance
▶ Documented Quality Management System	▶ Process Control	▶ Corrective Action
▶ Design Control	▶ Inspection and Testing	▶ Quality Records
▶ Document Control	▶ Inspection, Measuring, and Test Equipment	▶ Quality Audits
▶ Purchasing	▶ Inspection and Test Status	▶ Training

A matrix of our QMP's document precedence is shown in Figure 3.2-1.

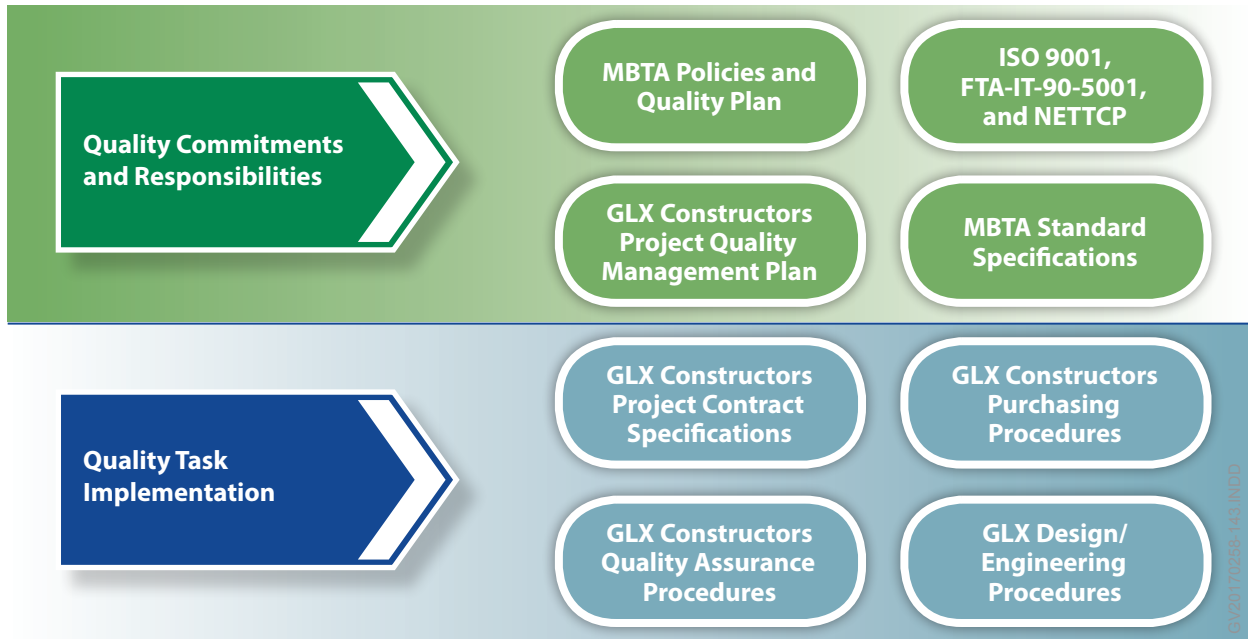

Figure 3.2-1. Our Quality Management Plan Document Precedence. *Establishing documentation precedence organizes the multiple, applicable quality documents.*

3.2.A APPROACH TO QUALITY MANAGEMENT SYSTEM

GLX Constructors will satisfy the requirements of the DB Contract. In doing so, we believe it is important for staff to hold sufficient authority to confront any potential quality complication. As such, our staff will have the autonomy and authority to implement immediate “stop work authority” for recognized, non-compliant issues, and to use simplified solutions to solve any quality-related issue before it is encountered. Our Management Team recognizes that, to be successful, personnel require sufficient authority and organizational freedom to identify a problem and initiate appropriate solutions. GLX Constructors’ QC personnel will verify that we have properly designed and installed the compliant solution, and that it meets or exceeds the MBTA’s quality requirements.

The Project Executive retains the overall authority for administering the QC system laid out in the QMP. Our Project Manager, John West, is responsible for all aspects of design, construction, and installation. John reports directly to our Project Executive, Clyde Joseph. Concurrently, our Quality Manager, Sandro Plutino, is responsible for implementing the QMP, and he likewise reports to Clyde. An illustration of our Quality Organization is presented in Figure 3.2-2.

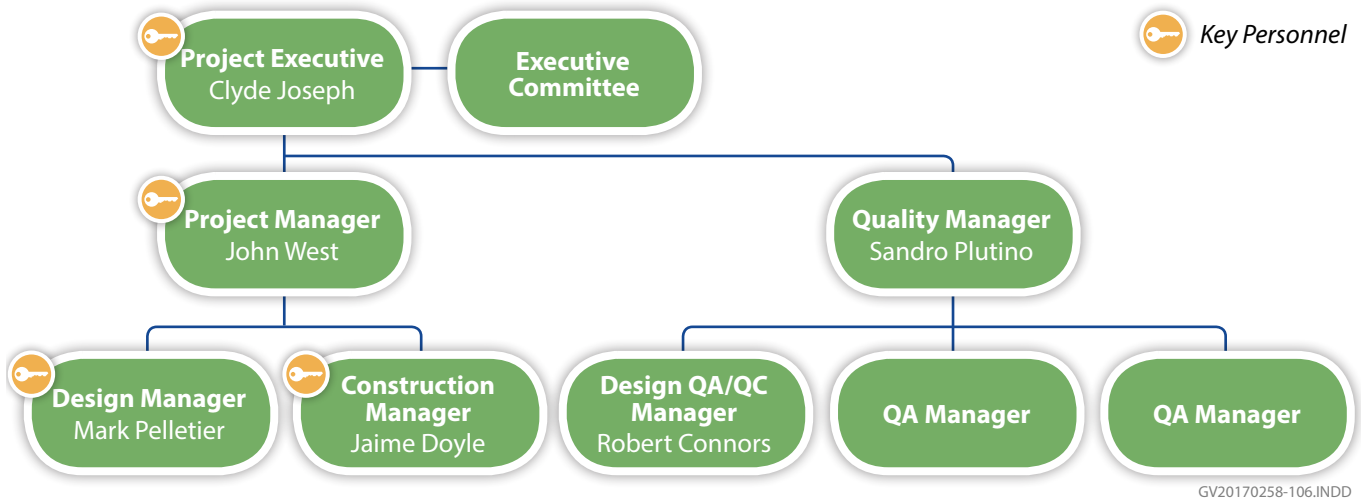

Figure 3.2-2. GLX Constructors' Quality Organization. *GLX Constructors' Quality Team will remain independent from the Design and Construction Teams.*

Figure 3.2-3 indicates the percentage of time dedicated to the Project by the Quality Organization Personnel.

Position	Percentage of Time Dedicated
Quality Manager	100%
Construction Quality Control Manager	100%
Construction Quality Assurance Manager	100%
Construction Quality Control Engineers	100%
Design Quality Manager	100%
Design Quality Control Engineers	100%
Construction Quality Assurance Technicians	50%
Independent Design Quality Control Reviewers	20%
Independent Quality Auditor	20%

Figure 3.2-3. Quality Organization Dedication. *The percentage of time that each personnel listed in the Quality Management Plan will be dedicated to the Green Line Extension DB Project.*

GLX Constructors believes quality, like safety, begins and ends with each individual member of the entire Project Team. Each person is charged with the requirement to produce their work to the highest standard of quality, and to speak up when observing actions that go against our beliefs about quality. When the total quality approach is adhered to, the responsibilities of the Design Quality Control Manager (DQCM) and the Construction Quality Control Manager (CQCM) are simplified to documentation of compliance with the QMP requirements. This allows the Quality Team to be independent from the Operations Team while supporting our common objective – quality across the entire Project.

In the event that quality-related issues cannot be resolved within a typical, organizational manner, the Quality Control Manager will be required to present these issues to the attention of the Project Executive and the MBTA for final resolution.

GLX Constructors' Management Team has established its commitment to quality on the Green Line Extension DB Project through a comprehensive Quality Management Program, including the following guiding principles:

- ▶ Communicate the importance of meeting customer, statutory, and regulatory requirements
- ▶ Conduct quarterly management reviews
- ▶ Provide resources necessary to meet Project requirements including training to the system
- ▶ Continually improve our work processes and deliverables through feedback, audits, and checks

The tasks and processes required to meet these commitments will be defined throughout the QMP.

Robert (Bob) Connors will serve as GLX Constructors' Design Quality Assurance and Quality Control Manager. Bob is a Certified Manager of Quality/Organizational Excellence and a Certified Quality Auditor from American Society of Quality. He is also a Certified Quality Assurance Technologist from Northeast Transportation Training and Certification Program. A registered Civil and Structural Engineer in Massachusetts, Bob has served on numerous successful projects for MassDOT and the MBTA, including the Longfellow Bridge Rehabilitation Design Build, Hingham Intermodal Center, Fore River Bridge Replacement Design Build, and the Greenbush Line Rail Restoration Design Build.



Robert (Bob) Connors
Design QA/QC Manager

3.2.B QUALITY POLICIES AND OBJECTIVES

Our Quality Policy is based on the fundamental concept that quality control is a team-obligation to build quality into every aspect of the Project. Our team will provide quality products and services that meet or exceed the MBTA's and FTA's requirements and standards, delivered safely, on time, and within budget. Quality will be the responsibility of every individual performing the work.



After the first phase of the Longfellow Bridge Rehabilitation DB Project, Bob Connors and his team formed a dedicated team of quality and management personnel to monitor quality trends, perform quality audits, and take action to improve quality. As a result, the number of Non-Conformance Reports was reduced from over 31 significant NCRs with in-place construction in the first phase, to 10 minor NCRs in the final phase, all of which were resolved offsite in fabrication shops prior to on-site arrival.



**GLX Constructors’
Quality Management
System is permeated
with the MBTA’s vision
for the Green Line
Extension DB Project,
our innovative
approach to the work,
and the integrity of
our Key Personnel to
get the job done right
the first time.**

Quality will be obtained through appropriate planning and control of work operations, as well as specific quality control activities, such as reviewing, checking, inspecting, testing, surveillance, and auditing.

Our QMP will be developed under the following guiding Quality Objectives:

- ▶ Implement well-designed quality programs that meet or exceed the MBTA’s and the FTA’s quality standards, and continually improve our process as the Project progresses.
- ▶ Partner with the MBTA to make design, construction, and management processes open to inspection and oversight.
- ▶ Effectively communicate our quality program to all relevant Project team members and provide sufficient training for proper implementation.
- ▶ Collaborate to incorporate best practices and seek out the MBTA’s opinion for quality feedback.
- ▶ Base decisions on factual, auditable information, and bring on subcontractors and suppliers who are committed to providing a superior end product.

The above guiding Quality Objectives of our QMP comprise and address the following dimensions¹, which make certain our QMS complies with the Project requirements:

- ▶ **Performance.** The Project’s main operating or functional characteristics.
- ▶ **Conformance.** How the Project will be measured as meeting the contract specification.
- ▶ **Reliability.** The mean time or distance between failures.
- ▶ **Maintainability.** The mean time to repair.
- ▶ **Availability.** The percent of time the system is available for service.
- ▶ **Aesthetics.** Appearance, color.
- ▶ **Features.** Functionality, beyond the main operating or functional characteristics.
- ▶ **Durability.** Ability to adapt to ambient conditions.
- ▶ **Safety.** Freedom from hazards.
- ▶ **Warranty.** Freedom from defects for a specified period of time.
- ▶ **Service Life.** Expected time prior to major overhaul of the system.

A final QMP, including Quality Policies and Quality Objectives, will be developed and detailed based on these objectives at Project Award.

3.2.C GLX CONSTRUCTORS’ RECORDS MANAGEMENT PROCEDURES

GLX Constructors’ Quality Manager, Sandro Plutino, will review, update, and maintain the QMP based on our discussions during Quality Management

¹FTA Quality Management System Guidelines, 2012

Meetings. The QMP is a living document, and it is subject to revision as necessary to facilitate and improve the quality process for the Project. We will maintain quality records to provide evidence of conformity with the objectives and requirements of the Document Management Plan and the QMP. Completed forms, including audit forms, and documents will be write protected.

It is a major benefit to the MBTA that our Quality Management Team will utilize a web-based database program, Engineering and Laboratory Vital Information System (ELVIS), provided by Raba Kistner, for the Green Line Extension DB Project. Used on over \$14 billion of GLX Constructors' team members' construction projects across the country over the last 13 years, ELVIS efficiently stores and interprets a comprehensive range of documentation. ELVIS is easily customized to fit the needs of individual projects, providing key features for construction engineering and inspection, including, but not limited to:

- ▶ Web access grants users anywhere access to project records
- ▶ Security controls for the Project
- ▶ Contract requirements tracking and verification
- ▶ Design submittal tracking and review
- ▶ Constructability submittal tracking and review
- ▶ Email notifications for critical processes
- ▶ RFC Plans entry and viewer by section and/or sheet
- ▶ Engineering decision documentation and tracking
- ▶ Data input through electronic tablet devices
- ▶ Failing tests disposition and tracking
- ▶ Approval and tracking of material submittals
- ▶ Non-conforming work tracking and resolution
- ▶ Integrated quantity tracking of all materials delivered and installed
- ▶ Material Management Tools
- ▶ Analytical tools for material quality evaluation (control charts/statistical validation)
- ▶ Punchlist module for Project closeout
- ▶ Numerous search functions for quick retrieval of records
- ▶ Transmittal generation
- ▶ Logs for incoming and outgoing correspondence

The ability to access ELVIS in the field via a tablet device allows us and the MBTA to access Project plans that incorporate new field design

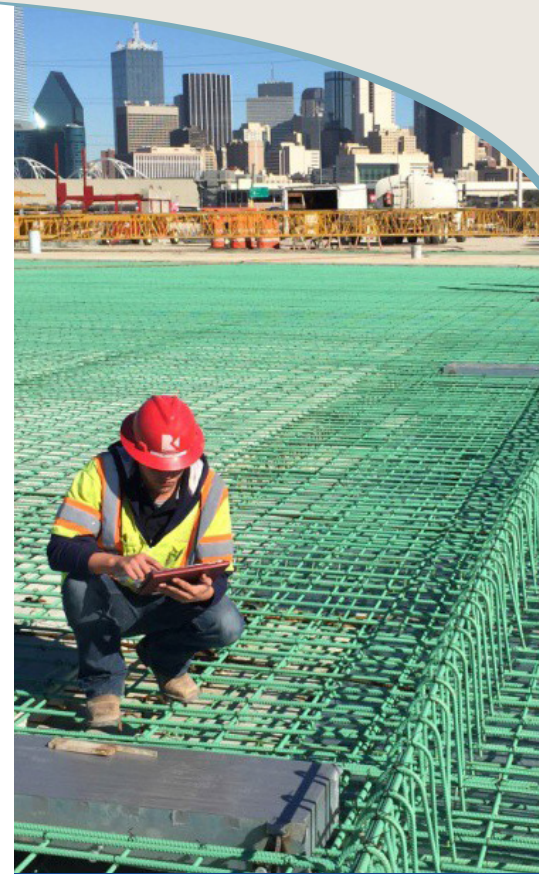

Inspector entering the Inspection Record into ELVIS on one of our Past Projects, the Dallas Horseshoe DB Project. ELVIS provides web-based access, which improves data collection and access in real time.

changes as they are approved, reducing potential errors caused by using outdated plans.

ELVIS’s high functionality and user-friendly interfaces allow for real-time access to Project data, providing unprecedented levels of transparency to construction projects. This facilitates open, quick communication that leads to successful partnering. We will provide the MBTA with access to this system, which will allow the MBTA staff to collaborate in real-time on all aspects of the construction process.

This system will serve as the Electronic Quality Document Management System (EQDMS) for the Project during design and construction, and GLX Constructors will use ELVIS to transmit official correspondence to the MBTA.

ELVIS will maintain current versions of project documents and all controlled Release for Construction (RFC) plans, quality reports, and testing documentation to serve as justifiable evidence confirming established processes are followed and Project requirements met.

GLX Constructors’ team members have used ELVIS on the following projects shown in Figure 3.2-4, including, but not limited to:

Project	Agency	Year Complete	Size	Role of ELVIS
SH 130 DB, 1-4, Austin, TX	TxDOT	2007	\$1.2 B	Independent Quality Firm (IQF)– Construction
I-15 CORE DB, UT	UDOT	2013	\$1.1 B	IQF–Design and Construction
SH 130 DB, 5-6, Austin, TX	TxDOT	2013	\$1.2 B	Independent Engineer
Horseshoe DB, Dallas, TX	TxDOT	Ongoing	\$800 M	IQF - Construction
Tappan Zee Bridge DB, NY	NYSTA	Ongoing	\$3.1 B	Quality Documentation
Bergstrom Expressway DB, TX	CTRMA	Ongoing	\$650 M	Developer Quality Control
South Mountain Freeway DB, AZ	ADOT	Ongoing	\$900 M	IQF-Construction

Figure 3.2-4. Our Past Experience with ELVIS. GLX Constructors’ team members have experience using ELVIS as their Electronic Quality Document Management System on DB projects of similar size and complexity as the Green Line Extension DB Project.

In addition to the above, ELVIS is capable of the following:

Design Documents. ELVIS tracks and logs design submittals, design review comment documentation, and RFC drawings. At each stage of design review, ELVIS automatically generates emails to notify identified users when plans or comments are ready for review or response, and tracks response deadlines. Changes to approved RFC designs – notices of design change (NDC) and field design changes (FDC) – are tracked and retained for inclusion in the as-built plan sheets to document the actual improvements

constructed. In addition, the RFC Module grants users in the field access to RFC sets, which incorporate new NDCs or FDCs as they are approved. This module allows the user to view plans as entire sets, specific design sections, or individual sheets in an effort to provide the information needed as quickly as possible.

Project Submittals and Documentation. ELVIS provides platforms to store, track, and easily retrieve project submittals and documentation such as Contract changes and deviations, management plans, certifications, material submittals, meeting minutes, quality reports, audit reports, close-out reports, photos, acceptance testing, utility data, and other official documentation/correspondence as required by the Contract Documents.

Inspection Documentation. Inspectors will log their work in Daily Inspection Reports. These reports track Inspectors' observations, communications with other Project staff, materials placed, samples/tests taken, photos, and any deficiencies identified. Daily Inspection Reports will also track Project Hold Points to properly identify the acceptable completion of work elements that must be completed for subsequent work to proceed.

Non-Conforming Work. ELVIS will track and log the details of non-conforming work through identification, resolution, and closure.

Material Testing and Management. ELVIS maintains comprehensive material testing records, with each test being assigned an individual Lot Identification Number. The testing modules in ELVIS also provide tracking for failing test disposition and resolution, and Engineering Decision documentation, as well as material quantities and Minimum Sampling and Testing Requirements.

Analytical Tools. The Dashboard can be customized to individual users to display data charts specific to their areas of oversight. This allows Project Management to quickly identify trends in work that may adversely affect Project quality, schedule and/or cost.

Punchlist. The punchlist module identifies specific items of work to be completed prior to Project Closeout and tracks each issue through resolution and acceptance.

Project Closeout. The ease with which a user can search for, retrieve, and review project documentation within ELVIS makes Project Closeout a quick and accurate task. The Project Materials held within ELVIS will be delivered in their entirety upon Project Completion. In addition, the data from ELVIS is easily exported to other systems, such as ProjectWise, at any time throughout the duration of the Project.



Analytical Quality Evaluation: We track the number of nonconforming work tests as a percentage of total inspections and tests which provide a trend analysis and will help our team drive improvement.

Documents Control Plan

GLX Constructors will maintain a standardized system to control, file, and archive all project documents supplemented by the ELVIS system. Procedures will make certain that relevant documents are current and readily available to the MBTA and the users who require them.

A master set of the latest project documents will be managed in a controlled fashion so documents can be stored, retrieved, obsolete documents removed, and document changes controlled. The types of controlled documents include:

- ▶ Drawings
- ▶ Specifications
- ▶ Calculations
- ▶ Inspection Procedures and Reports
- ▶ Test Procedures and Reports
- ▶ Calibration Records
- ▶ Work Plans
- ▶ Operational Procedures
- ▶ Risk and Contingency Plans
- ▶ Project Management and Quality Plans
- ▶ Safety and Security Management Plans
- ▶ Non Conformance Reports
- ▶ Corrective Actions
- ▶ Quality Audits
- ▶ Quality Training Records
- ▶ Résumés

We will work collaboratively with the MBTA in developing a document management system. We recommend using ELVIS for Quality document control for the following reasons:

- ▶ **Essential and Practical Management Tools for Accelerated Project Delivery.** Accommodates DB and other accelerated project delivery methods' requirements for fast input and quick turn around on changes and quality determinations.
- ▶ **Shortens Project Closeout.** Stakeholders can find outstanding items easily throughout the Project without waiting for paperwork to catch up at the end of a project. Results in a significantly shorter punch list at close out as most problems have already been resolved.
- ▶ **Transparency and Integrity.** Owners and developer team members have complete, real time access to design, submittals, testing and inspection records thereby building trust in partnering and working together.
- ▶ **Risk Management.** Creates a comprehensive, situational picture of the Project that helps decision-makers determine the right choice more quickly against risk metrics.
- ▶ **Lessons Learned.** Our experience and continually improved ELVIS presents valuable lessons learned from successful execution of QC/QA/OV/IA roles on infrastructure projects.

- ▶ **ISO Compliant.** Compliant with five core ISO procedures and integration with the Quality Management System.
- ▶ **Modular Components and Flexibility.** User write protected QC, QA, Independent Assurance, and Owner access of the secured EDMS with a design suite, construction suite, and a whole suite of ASTM, AASTHTO and DOT test methods.
- ▶ **Statistical Analysis.** Continuous analysis of t- and F-tests with p-values as shown in Figure 3.2-5.
- ▶ **Paperless Reporting and Records Delivery upon Completion.** Searchable database for source and produced documents for quality compliance.
- ▶ **Automated Trend Lines.** Trending can help our team identify preventative actions as shown in Figure 3.2-6.
- ▶ **Automated Quantity Tracking and Testing Frequency Compliance Extensive Management and Search Tools.** Search engine with comprehensive filters by controlled vocabulary list for individual and summary reports.
- ▶ **Automated Monitoring and Tracking of Non- conformances.** Automated initiation and tracking of construction deficiencies and nonconformances with documentation of corrective actions, dispositions, and resolutions of the deficiencies and non-conformances.
- ▶ **Email Notifications.** Timely delivery of critical information and required decision request requirements.
- ▶ **Ready and On-Line Access.** Released for Construction Plans and Specifications, approved materials and personnel, Construction Quality Management Plan and associated work instructions, procedures, and checklists.

3.2.D QUALITY MANAGER REPORTING AND AUTHORITY

Our Quality Organization will be independent from our Construction Organization. Our Quality Manager, Sandro Plutino, will report directly to Project Executive, Clyde Joseph, and the Executive Committee on the same level as the Project Manager. The Quality Manager will have a simple, informational communication line to the Project Manager. In this manner, Sandro and Quality Organization will provide true verification and confirmation of the constructed system's compliance with the requirements. Sandro will be under the direct authority of the Project Executive, Executive Committee, and – by definition – the MBTA for “stop work authority” as it applies to complying with the project requirements. Our Quality Organization supports, but verifies, the Construction Organization.

Material Category:	Embankment, Borrow and Backfill	Material Property:	In-Place Density
Query Condition 1:	All Grades	Maximum QO Test Number:	14
Query Condition 2:		Query Condition 3:	
Statistical Validation Period:	6/6/2014 - 1/23/2015	Alpha Level:	0.01
QO Test Sample Type(s):	Random-Independent	QA Test Sample Type(s):	Random-Independent and Random-Split

QO Data Point #	14	QO Mean	97.06	QO St. Deviation	2.472
QA Data Point #	1216	QA Mean	95.95	QA St. Deviation	2.071
F Value	1.425	Critical F Value	2.312	Equal Variance?	Yes
T Value	1.991	Critical T Value	2.580	Equal Mean?	Yes

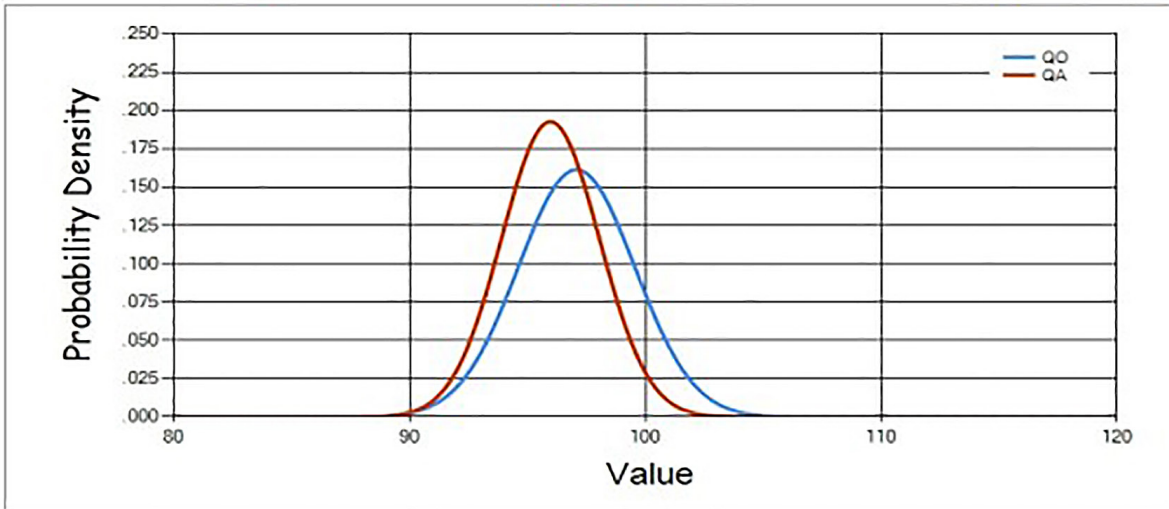

Figure 3.2-5. Statistical Analysis Example. Using Statistical Analysis will help GLX Constructors identify root cause.

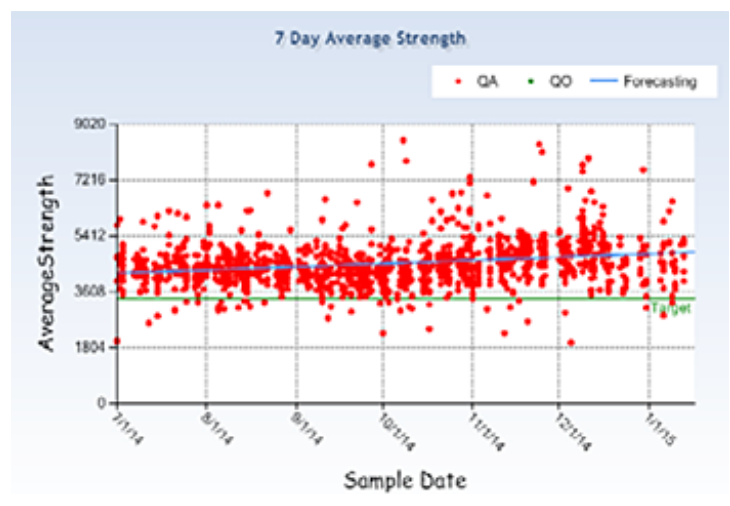

Figure 3.2-6. Automated Trend Lines Example. Trending can help GLX Constructors identify preventative actions.

Subcontractors, Suppliers, and Fabricators

Subcontractors, suppliers, and fabricators will be evaluated on their commitment to quality. We believe those performing the work are experts and, therefore, the most appropriate to control quality. Subcontractors, suppliers, and fabricators will provide their quality plans to GLX Constructors for review and approval.

If the subcontractor, supplier, or fabricator plans meet or exceed our QMP, their quality plan will be accepted. If the subcontractors, suppliers, and fabricators quality plans do not meet or exceed our QMP, they will be required to modify for compliance. They may adopt our quality plan as their own. If the subcontractor, supplier, or fabricator elects to adopt our QMP, we will train them accordingly.

While we trust our subcontractors, suppliers, and fabricators, our Quality Manager will verify their compliance with the required quality standards through verification testing and quality auditing.

Interfacing with the MBTA and Third Parties

The Quality Manager will interface with the MBTA and third parties transparently in our reports, decision making, and operations. We follow this approach to foster effective communication and continual improvement, which makes certain the MBTA is provided with a project of the highest quality.

The Quality Manager will provide guidance to the Project Management Team based on the following quality management principles:

- ▶ Customer focus
- ▶ Leadership
- ▶ Involvement of people
- ▶ Process approach
- ▶ System approach to management
- ▶ Continual improvement
- ▶ Factual approach to decision making

The Quality Manager will establish and chair weekly meetings to review quality reports, decisions, NCR status, and acceptance status. Additionally, a quarterly meeting will be held to review specific improvements, necessary revisions, or additions to the QMP.

3.2.E NON-CONFORMANCE REVIEW AND DISPOSITION PROCESS

A key component of our QMS and documentation process is the non-conformance module. When non-conformance issues are identified,

they are registered in the ELVIS system, which introduces an intermediate checkpoint that requires resolution prior to continuing the work. This develops the ultimate checks-and-balances for the Construction Phase, and it gives the MBTA authority in accepting the final construction product.

Non-Conformance Tracking System and its Required Components

The Quality Management Plan will identify design documents, materials, products, and construction that do not conform to Project's requirements. Each instance will be documented, evaluated, resolved, and corrective action taken to prevent a recurrence. The non-conforming material, product, or construction will be marked or tagged to prevent its unintended use. The material product or construction will not be used until the non-conformance is resolved. When the non-conformance is corrected, we will perform additional tests or inspections to verify the material, product, or construction is able to be properly used. Staff will be empowered, encouraged, and educated to report non-conformities as soon as they are discovered.

Non-conformities may be identified or discovered in multiple ways. Requests for Information (RFI) are typically questions from the Project site to the Design Team regarding changes to design plans or beneficial changes as a result of the site condition, and NDCs are the Design Team's changes to design documents. Both RFIs and NDCs are carefully implemented through procedures that document the discovery and resolution of non-conformity. In completing the resolution process, all non-conformities are tracked until they are resolved. By properly reviewing the forms, we can assess the reasons for the non-conformities, such as identifying whether the non-conformity is supplier or discipline related.

Quality staff will review data gathered through formal and informal audits, or any of the monitoring procedures discussed above, to assess performance against plans, objectives, and other defined Project Program goals. Through this and other forms of analysis, the Quality Manager, CQAM, and DQAM will seek to determine the root cause of the non-conformity.

The following flow chart, Figure 3.2-7, depicts the steps in identifying, resolving, confirming, and verifying the NCR process. Our process will provide the MBTA with a thorough, transparent procedure with sufficient notifications and check points for resolution.

Corrective and Preventative Response Strategies

When the quality of an item, material, workmanship, or service is unacceptable or indeterminable, we will use the non-conformance review and disposition process to document and resolve the issue. We will use written procedures and isolate non-conforming work so it is not inadvertently used or installed.

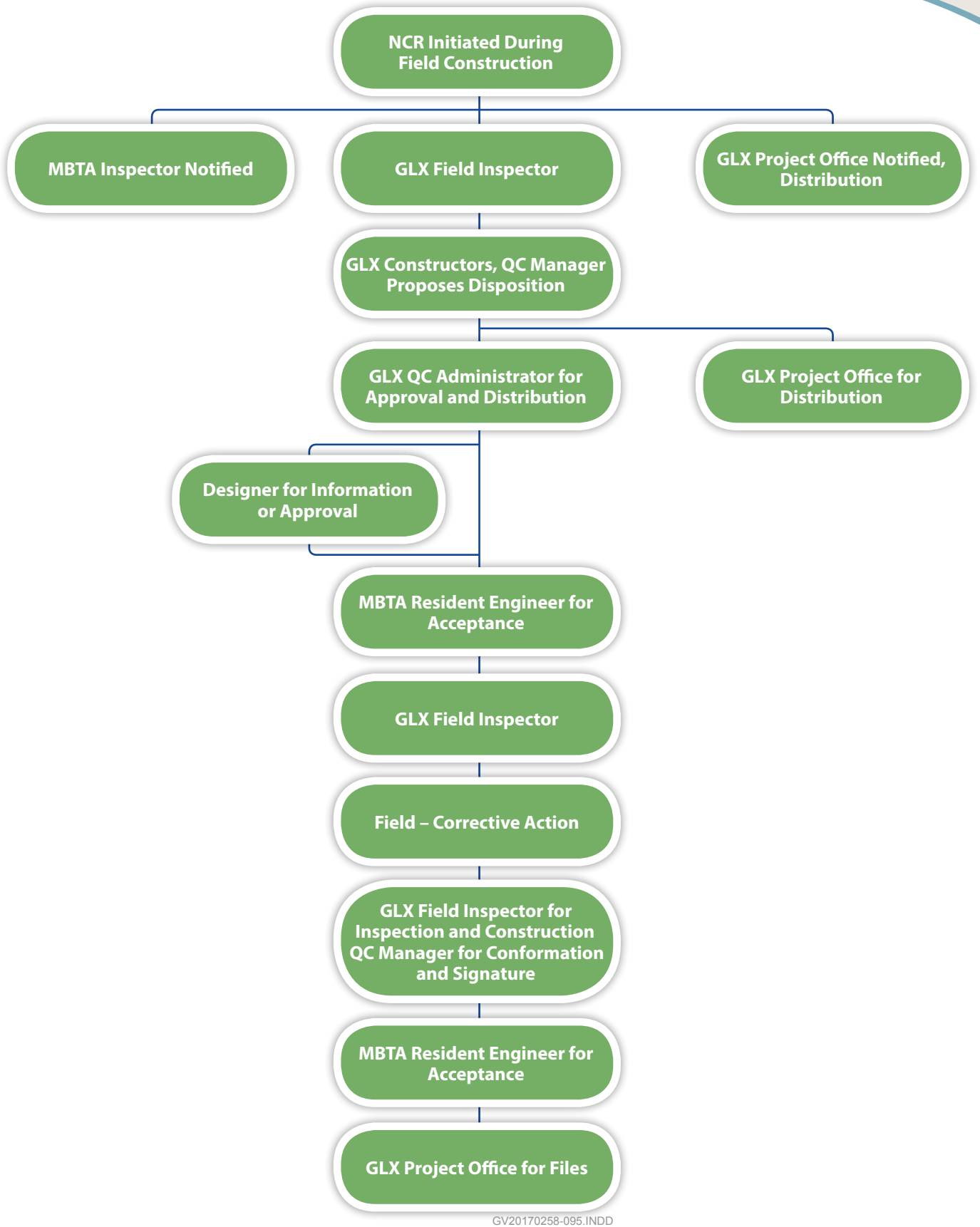

Figure 3.2-7. Non-Conformance Report Process. Processing through non-conformance reports is a prudent, collaborative process that is carefully documented and approved on multiple organizational levels.

For design documents, we rely on checking. For construction, we rely on inspection and testing. During checking, inspection, or testing, we gather data for strategic quality planning to find potential non-conformances, or identify trends or issues that may result in a non-conformance. If we identify a trend or issue that may result in a future non-conformance, we will analyze and implement preventative actions to eliminate root causes of possible non-conformities before they arise. The root cause analysis and implementation process is:

1. Identify the problem
2. List possible causes
3. Search out the most likely cause
4. Identify potential solutions
5. Select and implement a solution
6. Follow-up to evaluate the effect
7. Standardize the process to avoid recurrence

Any member of our Quality Team or the MBTA may initiate non-conformances. We will timely notify an MBTA representative if a defect is identified. Once we identify a potential issue, we will determine the cause of that problem. If the cause is not obvious, we will utilize techniques, such as a root cause analysis discussed above, to determine the reason for the non-conformance. We will follow the corrective action procedure.

Appropriate Quality Team members and the MBTA personnel will review and concur with the disposition of the NCR prior to implementing of corrective action. Once the approved corrective action is complete and verified, the NCR will be closed.

3.2.F INTERFACE WITH THE QUALITY MANAGEMENT SYSTEM

The QMS is the common denominator between our key management activities – including project controls, design, construction, rehabilitation, traffic management, environmental management, and project schedule management. The Quality Organization not only confirms our design and construction elements comply with the Project requirements, but they also review and confirm compliance on Project control reporting, Project schedule methodology and reporting, environmental management procedures and reporting, cost and invoicing compilation, traffic management plans and reports, and the rehabilitation of existing structures as required. Specific reports generated for compliance to the contract requirements will include signature approval by the Quality Manager or designee, as well as the Project Manager, prior to transmittal to the MBTA.

Another key feature of our QMS will be the internal and independent auditing of reporting, records, results, and procedures. This is part of our ISO

compliance and corporate commitment to continuous improvement – we define our process, execute our process, then check to confirm that our process and execution yields the expected positive results. Auditors will challenge these results on a random, unscheduled basis. These report results are used to identify potential weak areas of the QMS and prompt revisions as necessary to improve potential gaps.

Our QMS operates on creating an environment of checks, confirming results, identifying and correcting potential weaknesses, thereby continuously improving our quality processes.

We establish the QMS, train our personnel in the procedure and execution of the QMS and audit the results to confirm compliance. In addressing quality, every team member contributes to the Project Execution and each team member is involved in managing and improving the quality of the process for which they are responsible.

3.2.G COMPLYING WITH RELEVANT MANAGEMENT PLANS

The QMP is the primary document for developing and implementing our QMS. We train our workforce accordingly and make the plan available to all Project personnel. Because it is considered a living document, we will revise the QMP as the Project progresses. We will regularly maintain the QMP, at least annually, to make certain relevant processes, products, and services meet the established technical requirements. The QMP will comply with the requisite contract documents, codes, the MBTA's engineering requirements, the FTA's guidelines, and applicable standards. The plan will include processes to make certain the work is documented and verified.

As the Project progresses, training, education, and other resources will be necessary to meet or exceed the MBTA's quality requirements. To continuously improve products and services delivered to MBTA, we will focus on the following to ensure all personnel comply with our QMS:

- ▶ Training and Education
- ▶ Continual Improvement
- ▶ Teamwork and Employee Participation
- ▶ Focus on MBTA Satisfaction

Training and Education

We will assign responsibilities to our team members based on their qualifications, including education, skills, abilities, experience, and training. Their qualifications must be evidenced in their resumes. We will maintain resumes, and they will be available for the MBTA's review.

As we proceed through the Project cycle, our team members will need to continually re-educate, develop new skills, and sharpen proven skill sets. To meet this need for continual education and training, we will develop a Quality Training Plan. A training matrix will be developed to determine which team members require training in which procedures. We will maintain a training matrix that summarizes which Project team members attended specific trainings, and it will be available for the MBTA's review.

Our Quality Training Plan process will start with a "needs analysis" to determine the optimum solution to quality training and development. Our Design Quality Manager, Robert Connors, will provide quality training to the design staff, while the Construction Quality Managers will provide quality training to the construction staff. Training will be relevant, and it will focus on the quality plan for design or construction procedures, depending on the staff trained. Training will require sign-in. Project staff will be required to attend quality training, and we will maintain records to document participation.

Quality staff will receive quality training. NETTCP and ASQ will also be utilized to obtain and maintain quality certifications.

Continual Improvement

GLX Constructors will continually improve the effectiveness and efficiency of our activities and processes to provide added benefits to the MBTA, the Project, and the adjacent communities.

The initial procedure for continual improvement will be corrective and preventative actions. Corrective and preventative actions will establish procedures for identifying, documenting, determining cause, correcting, and preventing recurrence of non-conforming work. Corrective and preventative actions include implementing and recording changes in procedures resulting from preventive action, corrective action, and continual improvement initiatives.

A steering committee of senior Project personnel will oversee our continuous improvement. We will target processes that provide strategic Project advantages. Process changes will be based on the MBTA's feedback, needs, and potential impacts. Personnel involved in the process will be able to implement change. Processes will transform inputs to outputs, and decisions will be based on empirical data to the extent possible. Process changes will be evaluated to determine whether the desired impact was achieved.

Teamwork and Employee Participation

A successful QMP must be pervasive throughout any project. Therefore, everyone must participate to the extent that his or her job responsibilities

On UDOT's I-15 CORE Project, a Fluor-led joint venture team developed a comprehensive quality system utilizing two principle quality structures (quality assurance and quality control) with two complementary components for each structure. The program was based on requiring production elements to build quality into their work and providing a quality assurance (QA) function that is 100% independent of production and has the obligation to stop work if it is non-conforming. The production function was responsible for the quality of its work for both design and construction.

At the start of the project, UDOT intended to use a consultant-supplied system. However, after reviewing our QA system, decided to use our system instead. At present, over 6 million quality records are maintained in the system. As evidence of the client's satisfaction, Robert Stewart, PE, I-15 CORE Deputy Project Director for UDOT stated:

"... [this Fluor-led] team has brought a level of materials expertise to this project that rivals or perhaps exceeds our own. They have a level of sophistication regarding principles of quality that exceeds State highway industry standards. They couple this understanding with deployment hardware and software that has raised the level of quality in both the contractor's organization as well as ours. Their systems have helped us provide more evidence of conformity than any other project with which I've been associated."

allow. This includes members of senior management, functional management, and project management; functional and office staff; and shop and field personnel. In addition, consultants, contractors, and suppliers must adhere to our QMP.

Quality team leaders or quality management will select team members first by determining the needed competence. For us, competence comprises factors such as knowledge, experience, skills, aptitude, and attitude. We will use team-building processes for team members within our quality organization, and where possible, with the MBTA and other stakeholders to facilitate teamwork and participation. While people are our greatest resource, we realize they can also be the Project's greatest risk if not operating as a cohesive team. Quality team leaders and Quality Management will continuously evaluate personnel to confirm that team members are working in support of the overall quality objectives.

Focus on MBTA Satisfaction

Along with day-to-day, open communications with the MBTA and regular meeting discussions surround quality, GLX Constructors proposes to have weekly quality meetings with the MBTA to solicit quality performance feedback.

We will document the MBTA's feedback and respond to it in a timely manner. Areas requiring improvement will require corrective actions to be approved by the MBTA. Performance changes after implementing corrective actions will be tracked and discussed at the next quality performance feedback meeting, or more frequently as required.



We will constantly communicate with the MBTA to understand the issues that are most critical. We will not surprise the MBTA.

GLX Constructors will strongly impress upon our workforce that quality is the responsibility of every person involved with the Green Line Extension DB Project. As such, our QMS will comply with the MBTA's required standards, and it will comprehensively provide for the control and documentation of the Project's design and construction.

Our personnel will be effectively trained on the QMP's requirements, and design and construction works will be constantly monitored, documented, tested, and confirmed in "real time" to safeguard an acceptable and approvable final product.

We are confident in our QMS, which has been used extensively on other major Design Build Projects – on these projects, our QMS has proven to be an excellent tool for providing the Project's Owner with the most quality project achievable.

As stated, we are prepared to use ELVIS as a value differentiator to the benefit of both GLX Constructors and the MBTA.



As a 100 percent dedicated rail contractor, Herzog brings the depth and experience of operating 13 passenger rail systems. Current Operations and Maintenance (O&M) and/or Maintenance of Way contracts include:

- ▶ **Altamont Commuter Express**
- ▶ **Caltrain**
- ▶ **CTRail**
- ▶ **Kansas City Streetcar**
- ▶ **MetroRail**
- ▶ **New Jersey Transit**
- ▶ **Oklahoma City Streetcar**
- ▶ **New Mexico Rail Runner Express**
- ▶ **SunRail**
- ▶ **TEXRail**
- ▶ **Tren Urbano**
- ▶ **Trinity Railway Express**
- ▶ **Tri-Rail**

3.3 SAFETY, SECURITY, AND EMERGENCY MANAGEMENT PLAN

GLX Constructors will assess the Project's requirements and develop a Safety, Security, and Emergency Management Plan. We will provide the MBTA with a fully compliant program that comprises safety, security and emergency elements for protecting both the MBTA's operations workforce and the commuting public during day-to-day public use once the Project is successfully completed. Our Team has the requisite startup, commissioning, testing, and systems certification experience, and we apply our best practices during the Design and Construction Phases for Systems testing and commissioning, facilitating a seamless Project start up and reduced costs along the way.

GLX Constructors believes in safety first. Similar to our workforce Health, Safety, and Environmental (HSE) Plan, detailed in Section 3.2, we will approach the Safety, Security, and Emergency Management Plan requirements with the same goal: to design, build, and commission a transit system that operates with the safety of the MBTA's workforce and the traveling public as the most critical aspect of this Project.

Operational safety begins with developing the Safety, Security, and Emergency Performance Specification at the onset of the Project. This performance specification is the guideline for the formal system design, infrastructure construction, system testing and commissioning, and ultimately, system operations by the MBTA's Operations workforce.

As a team of industry leaders specializing in the self-performance of designing and constructing transit systems, signaling systems, and railroad operations and maintenance, GLX Constructors has a unique ability to draw on people within our organizations who have specialized expertise that is relevant to the Green Line Extension DB Project. To the benefit of the MBTA and the local community in which we work and live, GLX Constructors will make use of the variety of talent from our national



Figure 3.3-1. Rail Line Testing. *GLX Constructors' team members support dynamic envelope testing in Denver, Colorado.*



A valuable member of GLX Constructors' joint venture team, Herzog specializes in the operation and maintenance of light rail and commuter rail services. By reviewing the design drawings during Technical Work Groups, Herzog benefits the MBTA by identifying key elements that could be improved, including safe operations, security of the system, emergency ingress and egress, life cycle analysis, and the latest information on new product technology.

and global corporate resources to optimize each significant element of this Project to meet or exceed the MBTA's needs.

We have extensive experience in integrating systems and providing proper documentation to demonstrate that each Project component has been designed and constructed as required to obtain the necessary safety certification.

In addition, GLX Constructors is able to provide assistance and training to the MBTA's staff for long-term maintenance and operations, if requested. Our team members routinely provide these services to transit agencies across the country.

Our commitment to the MBTA is to bring our industry-leading expertise, coupled with our design, construction, and safety personnel, to provide the best solution for the Green Line Extension DB Project. Our expertise will provide a safe and secure solution and with our construction-driven execution approach to design and construction. This will produce the most efficient and economical solution.

Rail Activation

After completing the safety and security certification process, described in detail below, rail activation becomes a primary Project objective.

All stakeholders, including the MBTA's personnel, address rail activation steps – including testing and commissioning – that are required to make the system operational. A Rail Activation Committee, composed of staff from GLX Constructors and the MBTA, will be designated at the Project's onset. As we successfully move through the Project schedule, Rail Activation Committee meetings will become more frequent. When it is time to test and commission the Project, we will hold daily meetings and discussions amongst key members of the Rail Activation Committee.

In the field, GLX Constructors will take on all necessary testing and commissioning steps to make certain the system is operating as designed for all project elements, including track, traction power/OCS, signals, communications, structures, and facilities. The Rail Activation Committee's subject matter experts (SME) will be held responsible for verifying that each system element is working as designed. These SMEs will work with appropriate MBTA personnel to incorporate specific, required information elements into critical MBTA documentation, such as standard operating procedures, rulebooks, special orders, maintenance manuals, dispatchers' manuals, and asset management databases. The Rail Activation Committee must coordinate effectively with the MBTA's Light Rail Operations and Operations Control Center staff. It is critical that the Project operates safely during diversions in service, simulated operations, drills, and construction coordination.

GLX Constructors’ team members, Fluor, Balfour Beatty, and Herzog have prior experience in activating rail on design-build-operate projects throughout the United States. In addition, our Lead Designer, STV, comprises key personnel who have directly overseen light rail operations and safety for the MBTA. These GLX Constructors personnel have actively engaged in past MBTA light rail projects, such as the Riverside Line Reconstruction, the Lechmere Viaduct and Science Park Renovations, and the North Station Turnback Resting, Commissioning, and Revenue Service start-up.

Our team members have experience in complying with the Federal Transit Administration’s Oversight Procedure 54 – Readiness for Service. This document details the FTA’s process for evaluating the Project Owner’s readiness for revenue service. It provides the detail and documentation necessary to verify that, among other critical elements, the system integration, equipment, systems, safety and security certifications, and pre-revenue operations are in accordance with FTA and owner requirements, and that the Project Owner has the management capacity and capability to safely operate the service.

“
Our Project Manager, John West, oversaw transit systems safety and security certifications on both the West Rail Line and the Silicon Valley Berryessa Light Rail Extension DB Project.

3.3.A MANAGING SAFETY AND SYSTEMS ASSURANCE

GLX Constructors will implement a robust Safety, Security, and Emergency Management Plan early on in the Project. Our strategy will be to develop a plan that is in accordance with the MBTA’s System Safety Program Plan (SSPP) and the FTA’s guidance, rules, and regulations, such as the State Safety Oversight of Rail Fixed Guideway System. Outlined in Figure 3.3-2, GLX Constructors will develop our own Safety, Security, and Emergency Management Plan that is specific to the scope of the Green Line Extension DB Project.

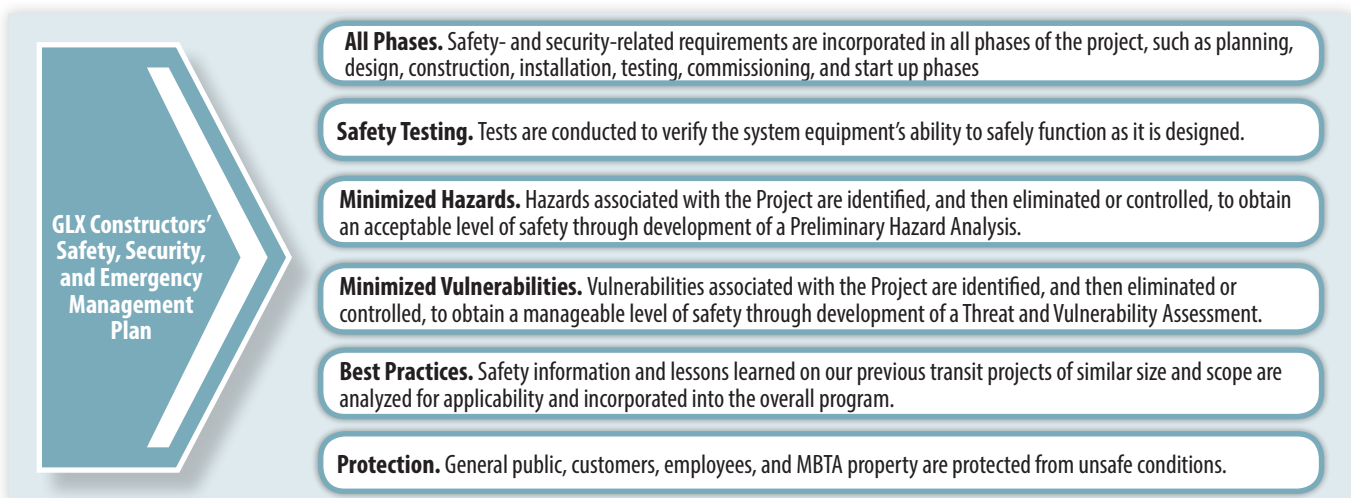

Figure 3.3-2. GLX Constructors’ Safety, Security, and Emergency Management Plan. *Our Safety, Security, and Emergency Management Plan will comply with the MBTA’s contractual requirements and comprise elements that are critical for operational safety.*



GLX Constructors will design, construct, and certify the Green Line Extension DB Project in compliance with both the MBTA's requirements, as well as those of the applicable federal regulatory entities.

The system safety and security disciplines manage hazards and vulnerabilities throughout the Project's life cycle through a committed approach to risk management. In this context:

- ▶ Hazard is a condition or circumstance that could lead to an unplanned or undesired event.
- ▶ Vulnerability is a characteristic of the system that increases the probability of occurrence of a security incident.
- ▶ Risk is an expression of the impact of an undesired event or security incident in terms of severity and likelihood.

Safety and System Security Certifications is a process to verify the proper application of system safety and security on the project. Through this process, hazards and vulnerabilities are translated into risks, which are then analyzed, assessed, prioritized, and resolved, accepted, or tracked. This process considers safety and security objectives during all phases of the Project Management process.

GLX Constructors will have a formal kickoff meeting and Project Management Meetings to establish the Project's requirements and review expectations. Our Team will work together to establish relationships and deliver the MBTA with skilled Project Staff that has experience with Safety and Systems Assurance Management on transit projects, both complex and simple. GLX Constructors has the experience to administer the Project's requirements and the FTA's requirements. We have successfully managed the systems and safety certification programs for many freight, commuter, and Light Rail Transit projects throughout the United States and Canada.

We have appointed Jean Claude Aurel as our System Safety and Certification Manager (SSCM) for the Project. Jean will have overall responsibility for leading the Safety, Security, and Emergency Management process to include Systems Assurance and Safety Certification activities. The SSCM will work with other Project personnel, including the Design

Our System Safety and Certification Manager, Jean Claude Aurel, is a Certified Safety Professional and system security expert with 20 years of diverse engineering and safety/security management experience, including threat and vulnerability assessments, gap analyses, hazard analyses, workforce training, and System Safety and Security Certification implementation. He has provided design review and project management on several streetcar, light rail, commuter rail, heavy rail and high-speed rail projects, as well as bus and ferry projects. His experience includes numerous design-build, design-bid-build, and design-build-operate-maintain mass transit projects. Jean is an experienced accident investigator, auditor, and manager of safety and security operations for bus and rail systems. He is proficient in Federal Transit Administration (FTA) SMS approaches, NIOSH standards, ADA regulations, NFPA codes, OSHA 29 CFR 1910/1926 standards, and ANSI standards. Jean will manage a team of experienced interdisciplinary project engineers to administer the MBTA's Green Line Extension DB Project's Safety and Security Certification Plan.



and Construction Teams, to develop the Technical Safety Report, the Technical Security Report, and the overall Safety, Security, and Emergency Management System. These items will ensure our compliance with the Project requirements, and they will confirm the availability of the required information and documentation that verifies the safety and security elements have been properly incorporated into the Project.

As an extension of our Technical Work Groups program, GLX Constructors will work with the MBTA to coordinate a Project System Safety and Security Certification Working Group (SCWG). The SCWG be established at the beginning of the Project, and it will:

- ▶ Comprise the MBTA's Safety officials, GLX Constructors' SSCM, GLX Constructors' Systems Leads, and other Subject Matter Experts (SME) as needed.
- ▶ Be tasked with reviewing and overseeing any plans and processes related to system safety certification, including hazard and vulnerability management.
- ▶ Meet on a regular basis to review the Project's progress to date.
- ▶ Ultimately be responsible for reviewing and approving the conformance checklists that validate the safety and system security certification effort.
- ▶ Develop meeting minutes to document the SCWG's efforts and become part of the project document control system.

The Safety and Security Certification (SSC) process, illustrated in Figure 3.3-3 will verify conformance to the Project design criteria, specifications, and test plans, as well as document operational readiness. It demonstrates the flow of information for each project phase. This process includes procedures for developing checklists that verify the Project is designed, constructed, and tested and cutover in compliance with the approved project documents.

GLX Constructors will assist with, or develop, the charter to establish a Fire Life Safety Committee (FLSC), and we will actively participate in the FLSC throughout the Project. The intent of the FLSC is to review standards and safety- and security-related designs and tests to verify fire life safety code and regulation compliance. Past experience on large transit projects have proven that the early formation of the FLSC is critical to minimize adverse schedule impacts resulting from differences of opinion on code interpretations late in the project delivery life cycle. Meeting minutes will be kept and become part of the Project Document Control System.

At Project completion, GLX Constructors will prepare and issue a Safety and Security Certification Verification Report (SSCVR) for the Project. The SSCVR will include a summary of all system safety and security activities



A system Safety and Security Certification (SSC) addresses conditions that could result in harm – whether unintentional (safety) or intentional (security). Our SSC process collectively verifies the Green Line's safety and security readiness for public use.

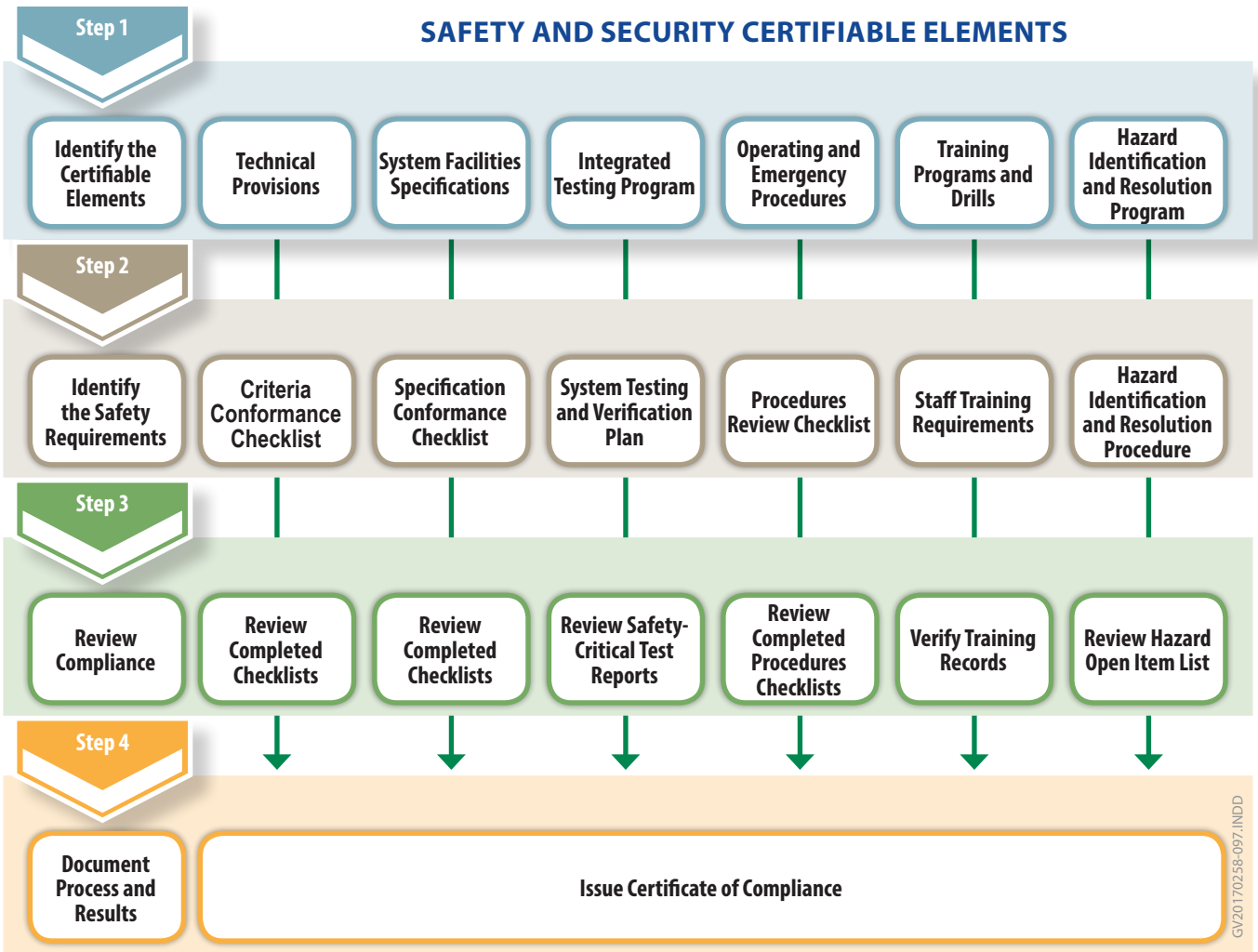

Figure 3.3-3. Safety and Security Certification Process. This process provides checks-and-balances for conformance to important Project requirements as stipulated by the MBTA, resulting in a Certificate of Compliance.

that occurred during the Project life cycle to include hazard analysis, conformance verification, and copies of the various project safety and security certificates that have been issued. The SSCVR will also include reference numbers to the various safety and security certificate submittals for the Project. The SSCVR will be the final safety and security certificate deliverable from GLX Constructors.

3.3.B METHODOLOGY TO EVALUATE AND DEVELOP SYSTEM ASSURANCE REQUIREMENTS

System assurance is a vital part of the design effort. The purpose for developing an effective system assurance program is to provide an explicit and direct influence on system design, construction, installation, and testing. GLX Constructors will develop a Systems Assurance Program Plan to provide a system that incorporates a high level of reliability, maintainability, and safety to meet or exceed Project requirements.

Our methodology to evaluate and develop system assurance requirements will include:

- ▶ Analyzing relevant operations data from the MBTA and other systems to interpret system availability goals into subsystem requirements while identifying areas of concern.
- ▶ Analyzing relevant maintenance data from the MBTA and other systems to establish subsystem maintainability goals and coordinate scheduled maintenance.
- ▶ Developing system models to allocate service reliability and restoration time requirements, and to establish subsystem requirements for high system availability.
- ▶ Establishing reliability and maintainability subsystem targets.
- ▶ Placing system assurance reliability and maintainability (RAM) requirements into subsystem specifications, including program, numerical, submittal, and demonstration requirements.
- ▶ Deriving subsystem RAM requirements from the RAM models and the specific RAM requirements contained in the Project baseline specifications.
- ▶ Requiring major suppliers, such as signaling, to provide a formal acknowledgment of the GLX Constructors System Assurance Program Plan.
- ▶ Analyzing system redundancy and fault recovery.
- ▶ Reviewing and compiling system assurance data received from suppliers to maximize high probability of each subsystem passing both the reliability demonstration and the maintainability demonstration.
- ▶ Developing a preventive maintenance plan based on subsystem supplier data and operating company requirements.
- ▶ Developing subsystem reliability and maintainability demonstration plans in accordance with the Technical Provisions.
- ▶ Issuing availability, reliability, and maintainability reports, as required by the Project baseline specifications coordination, and support for the system level reliability and availability demonstrations.

Hazards, Threats, and Vulnerabilities Management

GLX Constructors will develop a Preliminary Hazard Analysis (PHA) during the early phases of design development that may provide input to be used in the refinement of the Certified Elements List (CEL) and Certified Items List (CIL), safety and security design criteria, and overall project design. The items identified during the PHA will be included in the hazard resolution process during final design.

As the Project progresses through design and construction to startup, GLX Constructors will perform reviews to confirm that any potential change orders or MBTA approved deviations from the design criteria will not degrade the safety and security of the System.

GLX Constructors will maintain and update a hazards, threats, and vulnerabilities tracking log, complete with potential mitigation and resolution strategies. As threats and hazards are identified throughout the Design and Construction Phases of the Project, such as during analysis, design reviews, testing, and inspections, all potent threats and hazards will be recorded in the log.

All identified hazards or vulnerabilities will be tracked to resolution by the SSCM and the SCWG. As each threat and hazard is eliminated or mitigated to an acceptable level, the hazard tracking log will be updated with a description of the measures taken to resolve or mitigate the threat or hazard. This log will also be passed on to the Construction Team for use throughout the Construction Phase. The effectiveness of the mitigation will be reviewed by the SCWG to determine that no new threats or hazards have been introduced.

If necessary, GLX Constructors will schedule and chair PHA review meetings to allow for open discussions regarding agency reviews and to approve proposed resolutions or mitigations for any major security or safety issues and physical conditions resulting from a hazard analysis. Once the Project is under construction, all PHAs that have not been fully addressed or resolved through the design process will be converted to an Operating Hazard Analysis (OHA). In most cases, OHA resolutions are addressed through established operating rules and procedures.

We will also conduct or update an existing Threat and Vulnerability Assessment (TVA) to consider the likelihood of criminal or terrorism-related threats that could endanger the transit system. The ultimate objective of the TVA is to influence and provide support documentation to develop the Project security design criteria. We will use the process recommended by the FTA as outlined in *The Public Transportation System Security and Emergency Preparedness Planning Guide*, final report, dated January 2003.

Knowing the critical nature of any potential security issue related to the operational components of the Project, we will adhere to the MBTA's Sensitive Security Information policy, and we will include the appropriate verbiage on any document that contains such information.

Safety and security threats and hazards will be mitigated to an acceptable level by agreed-upon changes in the proposed design solution, in coordination with the MBTA and other jurisdictional entities, before the SSC process is complete.

When addressing a problem of non-conformance with a given requirement, GLX Constructors will employ reliability, maintainability, and safety principles to determine appropriate corrective action. For instance, we understand that while separate reliability and maintainability actions could each solve a problem, the preferred action might impact safety. In such situations, we will make certain that the problem cannot be considered “solved” if only reliability or maintainability, but not safety, is addressed.

3.3.C SAFETY, SECURITY, AND EMERGENCY MANAGEMENT ANALYSIS

Safety and Security Certification Plan

We will develop a Project-specific Safety and Security Certification Plan (SSCP) that aligns with the MBTA's SSCP, as well as the process identified in FTA requirements under Code of Federal Regulations (CFR) 49 CFR Part 633 “Project Management Oversight”; Part 659 “Rail Fixed Guideway Systems and State Safety Oversight”; and “FTA Project and Construction Management Guidelines,” which identifies FTA Circular 5800.1 “Safety and Security Management Guidance for Major Capital Projects.”

At a minimum, our SSCP will include these seven sections:

- ▶ Section 1: Introduction
- ▶ Section 2: Program Management, Organization & Responsibilities
- ▶ Section 3: Safety and Security Verification Process
- ▶ Section 4: Hazard and Vulnerability Management
- ▶ Section 5: Certificates of Conformance
- ▶ Section 6: Documentation
- ▶ Section 7: Reporting Requirements

In developing the SSCP, our SSCM, Jean Claude Aurel, will identify processes to make certain the following safety and security requirements have been addressed:

- ▶ Systems and equipment are designed, constructed, installed, inspected, and tested in accordance with applicable codes, standards, criteria, and specifications with respect to safety and security.
- ▶ Identified hazards, threats, and vulnerabilities are eliminated or controlled to acceptable levels.
- ▶ Appropriate safety and security verification documentation is provided.

Safety and Security Certification Tasks	Development	Preliminary Design	Final Design	Construction	Integrated Testing	Pre-Revenue	Operations
Develop safety and security policy							
Assign SSC responsibilities							
Establish safety and security committees							
Identify existing safety and security requirements for acquisition process							
Develop SSCP							
Identify safety and security certifiable elements and items							
Initiate SSC project documentation system							
Perform preliminary hazard and vulnerability analysis							
Prepare and update safety and security design criteria							
Integrate O&M requirements into design							
Perform safety and security design reviews							
Develop design criteria conformance checklists							
Perform additional hazard and vulnerability resolution and tracking							
Verify design criteria conformance checklists							
Identify safety and security requirements for test program plans, integrated testing, and operational readiness							
Develop specification conformance checklists (construction)							
Verify specification conformance checklists							
Issue permits and certificate (if applicable)							
Verify completion of integrated testing							
Safety and security review of engineering change orders and waivers							
Complete O&M plans, procedures, and training							
Complete operational readiness review							
Issue final safety and security certification							
Issue final safety and security certification verification report							

GV20170258-098.INDD

Figure 3.3-4. Safety and Security Certification Tasks. GLX Constructors will implement our best practices to eliminate, minimize, or control potential hazards or vulnerabilities to passengers, staff, property, and the general public.

As shown in Figure 3.3-4, we will implement best practices based on our past engineering, construction, and operations experience. Each of these requirements will eliminate, minimize, or control potential hazards or vulnerabilities to passengers, staff, property, and the general public. Mitigation techniques will utilize available design, engineering, and procedural measures throughout the term.

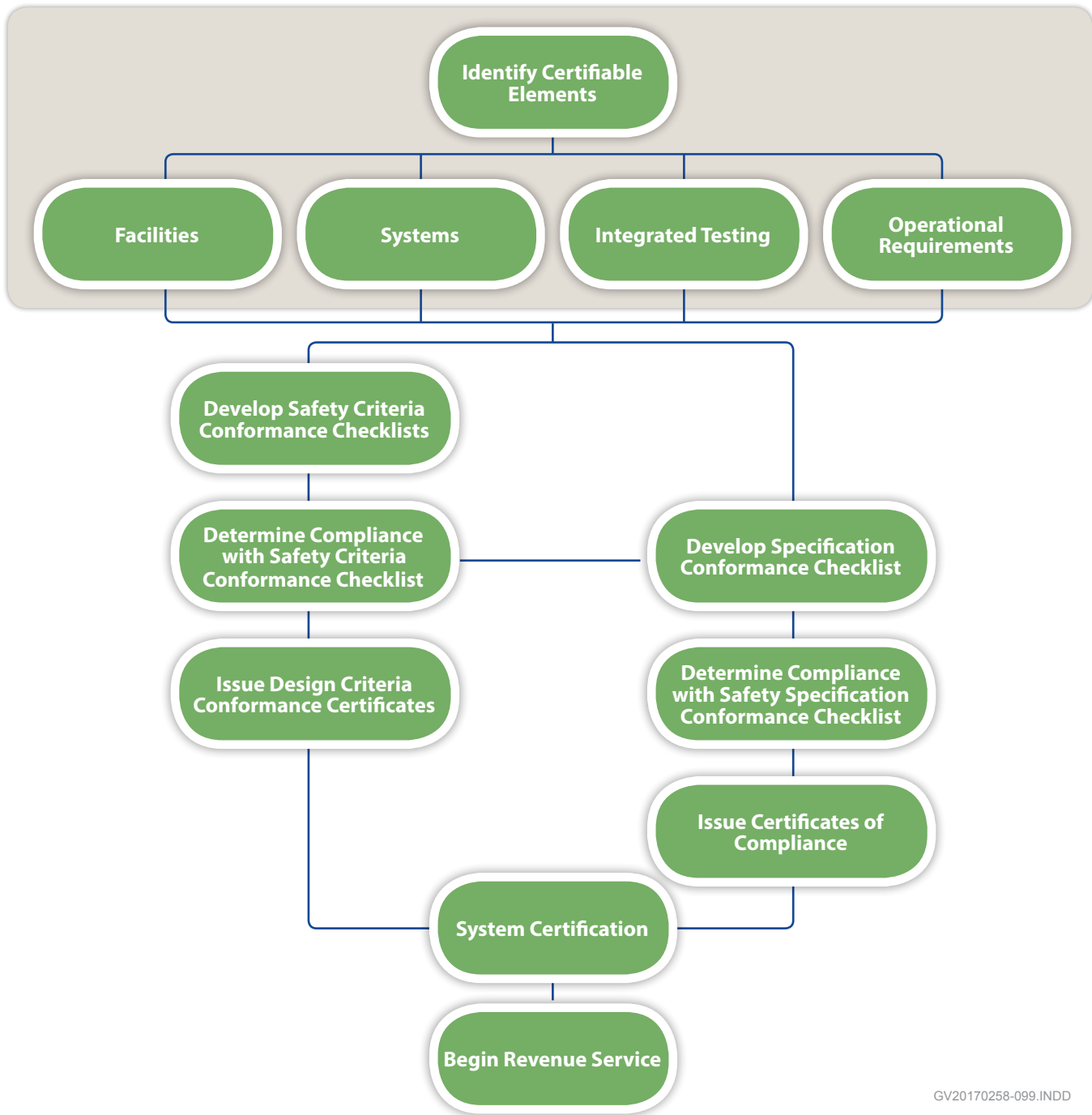

GV20170258-099.INDD

Figure 3.3-5. Safety Certification Verification Overview. *Our safety-driven process for Safety Certification approval, which is necessary to begin revenue service.*

GLX Constructors’ first step in the Safety and Security Certification process is to develop the Certifiable Elements List (CEL). As shown in Figure 3.3-5, the CEL will identify the elemental-level components that should be certified. From the CEL, the Certifiable Items List (CIL) will be developed, and it will identify all components and systems to be certified within the scope of the proposed deliverables of each of the items for the Project. The CIL may be reviewed and updated throughout the Project’s life cycle as needs are identified.

To validate the CIL, the SSCM will develop conformance checklists for design, construction, and testing. These checklists will be based on the approved Project design criteria, specifications, and test plans. Checklist completion for Design and Construction will be performed in conjunction with the Design and Construction Managers to make certain all identified safety or security requirements have been addressed. All checklist requirements will be tracked in an electronic database that will be provided to the MBTA at agreed-upon intervals for review and additional verification. The database will allow for all references to be maintained in one secure location, and it will provide for the easy viewing of items.

GLX Constructors will store safety verification documents within our Electronic Quality Document Management System (EQDMS), ELVIS, for the Project's life cycle. All of the items identified as part of the checklist requirements and hazard analysis will be tracked in a searchable spreadsheet. Updates to these documents will be submitted as outlined in the contract documents.

Any temporary non-conformances or deviations identified that are related to a certifiable element's safety or security requirements will be subject to a restriction report. GLX Constructors will track restrictions and approved remediation or correction measures until the non-conformance is resolved.

As mentioned in Section 3.3.A, a Safety and Security Certification Verification Report (SSCVR) will be completed at the end of the project. The SSCVR will be the final safety and security document, and it will include the status of safety and security certifiable elements lists; system testing activities; operation, maintenance, and training activities; and hazard identification and resolution.

Integration

The objectives of Integration Testing are:

- ▶ To demonstrate that traction power, communications, train control, civil design, and rail vehicles, when operating as a whole, satisfy the functional and performance requirements of the design, scope, services, and contractual obligations.
- ▶ Provide for documentation of successful integration testing to the MBTA for their final review and acceptance or work and initiation into revenue service operations.
- ▶ To provide documentation of integration testing as evidence for completion of the Project Safety & Security Certification process.

GLX Constructors' SSCM, Jean Claude Aurel, will actively work with our Systems Integration Manager, Aaron Neeley, to make certain all critical safety and security components of testing are fully integrated into this process and all test reports and documents conform to the Technical Provisions. We will capture conformance by using a checklist, which will be developed by GLX Constructors' SSCM and reviewed by the SCWG. The basis of this conformance checklist will come from the Project-approved Systems Integration Plan. Full details on the overall conformance process will be included in our SSCP.

Post-Construction Pre-Revenue Certification

As shown in Figure 3.3-6, the certification process will be an ongoing, ever-evolving process that culminates during the post-Construction Phase of the Project. The proposed process will follow the FTA guidelines and involve conformance verification to design, construction, testing, and operational readiness.

Our SSCP will progressively move through the Project life cycle and close items from the CIL as the documentation is formalized. This rolling process reduces the need for last-minute review or documentation issues post-construction, and it allows for the SCWG to review items throughout the Project life cycle. This proposed process flows with the Project Schedule, and it also creates fewer issues at the end of the Project with a seamless transition from the DB Phases into the final Testing, Commissioning, and Operating Phases.

At the completion of each phase, we will issue a Certificate of Conformance (COC) shown in Figure 3.3-7, which documents that the safety and security requirements have been satisfied for a particular element. Multiple COCs will be issued throughout the project life cycle and they will roll into the overall Project Safety and Security Certificate.

3.3.D TRAINING, EDUCATION, AND OTHER MEASURES

Our safety program will be inspired by, and similar to, the plans employed on our other successful safety projects throughout the United States. Our safety program for this project will be updated, tailored, and it will meet the full requirements of this Project.

Our SSCM and members of his staff will provide GLX Constructors' personnel and the MBTA's staff with in-depth safety training on work practices and compliance with the Safety, Security, and Emergency Management Plan. Training will consist of classroom and field sessions, which will holistically make certain the Safety, Security, and Emergency Management Plan is clearly communicated and well-understood by all personnel.

Figure 3.3-6. Example Project Safety and Security Certificate. *The Project Safety and Security Certification verifies the proper application of system safety and security disciplines on the Project.*

Figure 3.3-7. Example Certificate of Conformance. *The Certificate of Conformance documents our compliance to the Project's safety and security requirements.*



**On the Eagle P3
Commuter Rail Line
Project in Colorado –
delivered by Fluor and
Balfour Beatty, and with
PMO services provided
by STV – the Safety
Team implemented
track allocation and
rail alignment safety
training programs prior
to system energization
to protect our workers.
Any work performed
on or adjacent to the
tracks required safety
certification and
permission. More than
2,000 construction
personnel were trained.**

Our Project personnel will be up-to-date with the applicable requirements as well as those of the FTA.

Safety, Security, and Emergency Management are paramount to reducing risk to the MBTA, its systems, and the riders it will serve. The goal of Safety, Security and Emergency Management is to address conditions that could result in harm, and it promotes informed management decision-making processes into Project design, construction, testing, and into revenue service. GLX Constructors' Safety, Security, and Emergency Management Plan plays a critical role into our culture of safety, quality, and teamwork that positions GLX Constructors for a successful Project execution and a long-term partnership with the MBTA.

3.4 RISK MANAGEMENT APPROACH

Supporting the MBTA's Project goals surrounding cost and schedule certainty, GLX Constructors offers the MBTA a team that will minimize and manage any risk that may threaten Project success. Our experienced team will identify, assess, monitor, mitigate, and allocate Project-specific risks during each Project phase and activity. As a result, the MBTA can rest assured that we will live up to our goal of "no surprises" for the MBTA, maintaining cost and schedule certainty from Design through the Construction and Commissioning Phases of the Green Line Extension DB Project.



GLX Constructors' due diligence provides the MBTA with a high-level of confidence that potential risks and corresponding impacts have been mitigated in our Project design and construction. Our goal to identify and mitigate shared Project risks will be met – and the Project will be constructed on time and under budget.

Since the beginning of the Proposal Phase, our DB Management Team and critical risk personnel have focused on identifying, analyzing, and developing mitigation strategies for potential Project risks. For the past year, many individuals who will collaborate on a day-to-day basis with the MBTA – including Project Executive, Clyde Joseph; Project Manager, John West; Construction Manager, Jamie Doyle; and Design Manager, Mark Pelletier – have been fully dedicated to this project while preparing our design, schedule, estimate, and proposal. These four critical team members have collaborated with appropriate third parties and our Design Team to lead our Project Team's effort to fully understand the Green Line Extension DB Project risks. We have already begun the process to mitigate these risks.

Identifying, appropriately managing, and mitigating potential risk is essential to the on-time completion of the Green Line Extension DB Project. Through our extensive experience in DB project delivery, GLX Constructors has defined a systematic approach to implementing policies and procedures that enable us to effectively identify risks, appropriately manage those risks, and put the necessary controls in place to mitigate any potential risks from impacting the Project.

Utilizing the MBTA's knowledge, our team members have the collective and specific expertise necessary to develop a robust Risk Management Team, and we are prepared to evaluate and manage unknown risks before cost- or schedule-related issues manifest. We will convene our Risk Management Team at Project startup, and this team will develop regularly-scheduled evaluation and management meetings to be held until Project Closeout.

GLX Constructors' approach to risk management is a transparent process that minimizes and eliminates unanticipated surprises for all stakeholders. Our monthly Risk Review Meetings – attended by GLX Constructors and MBTA senior management – will make certain the MBTA is actively involved in the risk management process throughout the Project's life cycle, provide a forum for jointly discussing risks and potential mitigations, and raise awareness of potential risks to the appropriate management staff in a timely manner.



GLX Constructors partners with our clients to identify ways to manage unexpected events and Project risks to achieve cost and schedule certainty.

In asking the simple question, “What can go wrong?” and thinking through the likelihood, impact, and ways to reduce the risk, through up-front and contingency planning, the power of risk management becomes readily apparent.

We will minimize and manage risks that may threaten Project success, through identification assessment, monitoring, mitigation, and allocation of Project-specific risks during each project activity. Figure 3.4-1 illustrates our Risk Management Process.

GLX Constructors has established a Risk Management Plan (RMP) designed to minimize and manage risk. This plan is a Project-specific implementation of Fluor’s proprietary Business Risk Management FrameworkSM (BRMF), tailored specifically to the Green Line Extension DB Project’s needs.

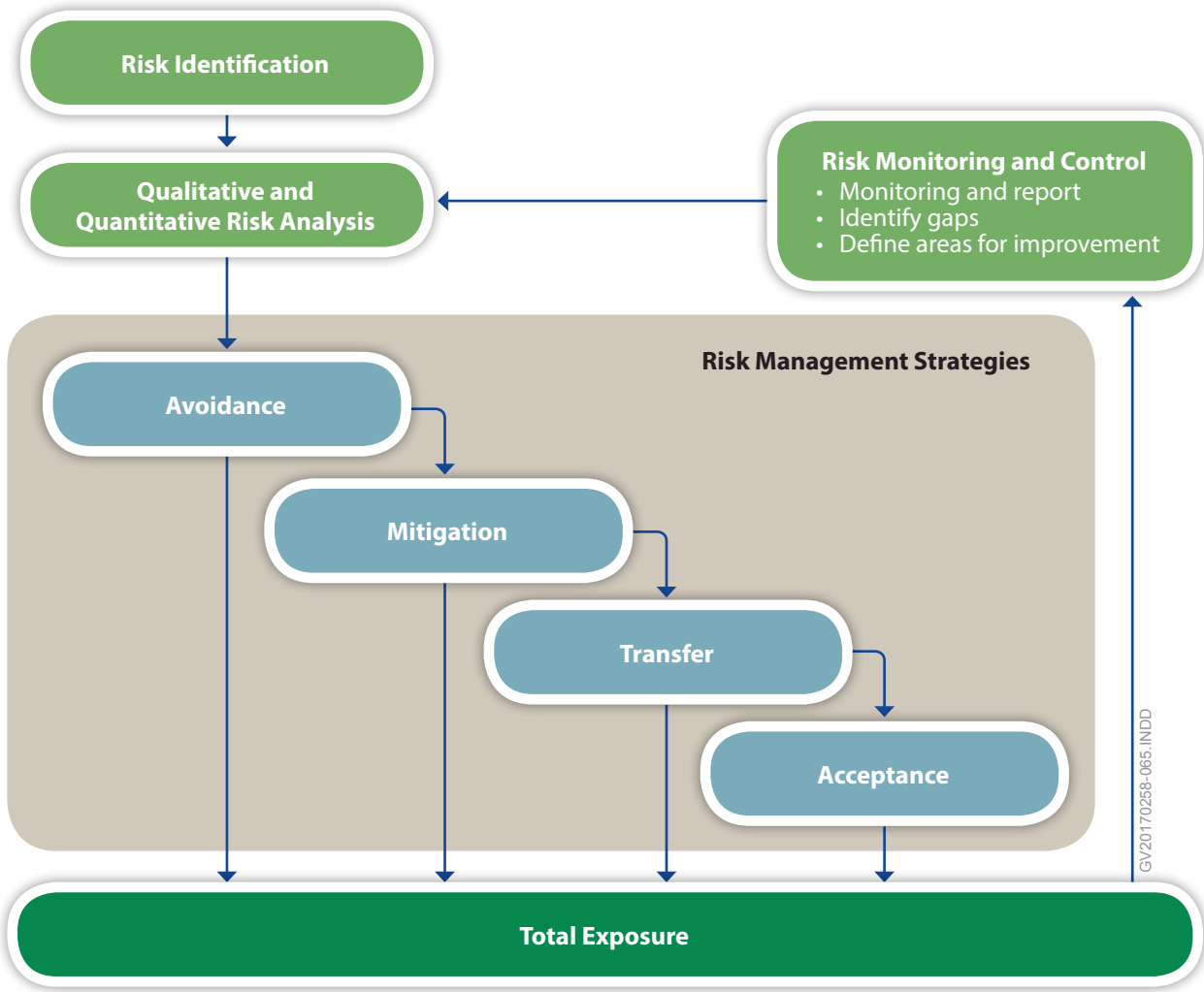

Figure 3.4-1. Risk Management Process. *GLX Constructors’ robust process will facilitate cost control and prevent schedule delay.*

By identifying potential risks that may implicate GLX Constructors, or jointly-held Project risks, GLX Constructors began executing our RMP during the Proposal Phase. These identified risks include, but are not limited to:

CONTRACTOR RISKS	THE MBTA/CONTRACTOR RISKS
Constructability	Schedule Certainty – Start Revenue Service
Contract Allocation	Utilities
Design and Construction Performance	Public/Media Exposure
Supply Chain Management	Public Safety
Environmental Conditions	Working near an Active Track
Permits	Adjacent Properties/Abutters
Geotechnical Conditions	Railroad Flagging
Inflation	Subsurface Risks
Material Supply	Environmental Management
Natural Disasters	
ROW Acquisition	
Utility Coordination	
Third-Party Expectations	
Coordination with Ongoing Railroad Operations	

As stated above, GLX Constructors has adopted Fluor’s proven BRMF as its primary risk management tool. The BRMF is a formalized, systematic process to identify, manage, mitigate, allocate, and monitor Project risks. Our BRMF will include MBTA risks that we will be able to impact or help mitigate. The steps of the BRMF process are detailed below and are illustrated in Figure 3.4-2.

- ▶ **Perform Risk Assessment.** Identify sources of risk, assign responsible party, establish unmitigated exposure value, assign severity, assign likelihood of occurrence, and define priority to rank significant risks. During this step, we prioritize identified risks as a function of likelihood and consequence severity. Consequences are ranked by estimated cost implication into categories: Minor, Moderate, Serious, Major, and Critical.
- ▶ **Select Preferred Risk Management Strategies.** Identify mitigation strategies/action plans to be implemented. We have researched each risk and its effective mitigations.
- ▶ **Develop and Execute Risk Management Plan.** Assess and revise mitigation strategies as necessary, obtain approval, and execute risk action plans.
- ▶ **Monitor and Report Risk Management Performance.** Periodically update the Risk Register throughout the Project’s life cycle.

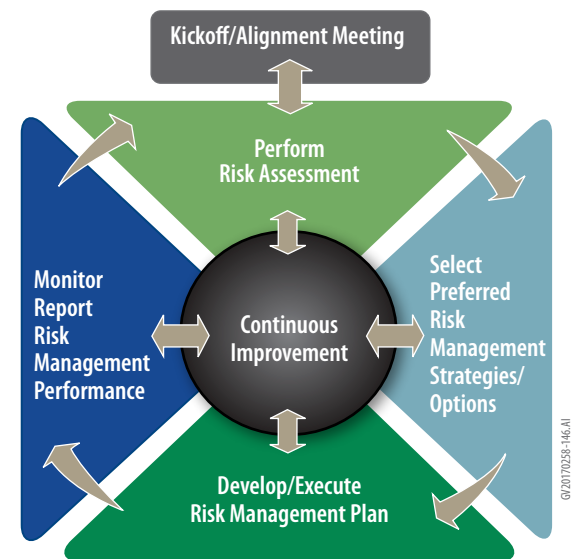

Figure 3.4-2. GLX Constructors’ Kickoff/Alignment Meeting BRMF Model. Our operational steps for successful risk mitigation.

As part of our analysis, we assign each risk an unmitigated and mitigated exposure value. Risks with remaining exposure are assigned a value range, assigned a probability of occurrence, and run through a Monte Carlo simulation. This computerized analysis has assessed the schedule, progress, and budgetary impact of risks associated with each Project component. This stochastic sensitivity analysis provides output that prioritizes Project risks, which allows our DB Management Team to focus on those with higher priority.

Within this section, we have included an extraction of our comprehensive Risk Register, shown in Figure 3.4-3, which identifies several key risks related to subsurface conditions, working near an active track, impacts to adjacent properties/travelling public, and other concerns. At the Project's commencement, we will further refine the baseline Risk Register. Throughout the Project, we will use our Risk Register to monitor risks and initiate mitigation activities. Follow-up in-depth reviews will occur quarterly on change events in relation to and at significant Project milestones. We will utilize formal Risk Workshops to track risks identified during the risk management process, and we will continue to identify, assess, mitigate, and manage new risks throughout the Project.

If a potential risk becomes an actuality, our Risk Manager, in conjunction with the DB Management Team, will implement the mitigation strategy that provides the greatest tactical advantage. This proactive risk management process will focus on cost control and preventing schedule impacts. This process has been effective on previous infrastructure projects performed by GLX Constructors' team members and provides schedule certainty.

Updating and addressing risks in the BRMF is an ongoing, iterative process that continues throughout the Project's life cycle, and it includes periodic reviews by both the DB Management Team and the MBTA's Management Team. Our Project Executive, Clyde Joseph, and Project Manager, John West, have been intimately involved in the risk management process during the Proposal Phase, and they will continue to lead this effort throughout the Design and Construction Phases. As part of the transition from construction and integration testing to operations and maintenance, GLX Constructors will work with the MBTA to transfer the Risk Register for continued monitoring and updating.

3.4.A SUBSURFACE CONDITIONS

See attached Risk Register, Section 3.4.A.

3.4.B WORKING NEAR AN ACTIVE TRACK

See attached Risk Register, Section 3.4.B.



For this Project, GZA has drawn on their relevant 53 years of design and construction experience in the local Boston area, which we have incorporated in our preliminary Project design.

3.4.C IMPACTS TO ADJACENT PROPERTIES AND THE TRAVELING PUBLIC

See attached Risk Register, Section 3.4.C.

3.4.D OTHER MAJOR RISKS

See attached Risk Register, Section 3.4.D.

Figure 3.4-3. Risk Register

#	Risk	Description of Risk	Additional Risk Details	Mitigation Plan/Strategies
3.4.A. Subsurface Conditions				
1	Subsurface Conditions	Differing site conditions	Differing site conditions are considered one of the most significant risks on any project. On this Project, differing site conditions have the potential to adversely impact schedule and costs on work associated with excavations for bridges, retaining walls, noise walls, station and catenary structure foundations, drainage lines, and bridge approach embankments.	<ul style="list-style-type: none"> ▶ To mitigate the effects of potential differing site conditions, GLX Constructors and our geotechnical design consultant, GZA GeoEnvironmental, Inc. (GZA), reviewed the available subsurface information provided on the boring logs and in the reference information documents, and we developed subsurface profiles that depict anticipated geotechnical conditions along the entire alignment. ▶ Additionally, GZA analyzed information from their adjacent projects, including the Commuter Rail Maintenance Facility, to provide a basis for the foundation design and selection for the adjacent proposed VMF. ▶ GLX Constructors performed extensive due diligence during the Proposal Phase to identify potential deviations in soil conditions. ▶ We have leveraged our Team's Project research and vast local design and construction experience to lower the likelihood of design issues related to differing site conditions, and to mitigate any impacts to the Project schedule. ▶ Immediately after Project Award, we will implement a supplemental geotechnical investigation program, detailed in Section 4.2, and sequence our final design with this geotechnical data collection and analysis. ▶ Included in our final design, this supplemental investigation program will include the results of the supplemental explorations and GZA's recommendations, which will be based on the assessed data. Such recommendations may include evaluating the profile to optimize wall heights, incorporating various ground improvements (e.g., surcharging wick drains, removing and replacing areas with poor soil), and considering alternative foundation types. ▶ GLX Constructors will allot specific time for geotechnical investigation and analysis into our Project schedule. ▶ To mitigate potential delays and costs derived from differing site conditions, we will analyze the Project schedule and then implement alternative construction strategies that allow for flexibility and minimize prospective lost time events. ▶ Alternative strategies may include redesign, accelerating the work, or resequencing the work. ▶ Possible differing site conditions and specific mitigations are included below.
2	Differing Site Conditions	Unknown obstructions in the historic fill at the south end of the alignment and in the area of the VMF, which could impact installing deep foundations	These obstructions include the unknown foundations for the two existing buildings to be demolished in the VMF Footprint, the details of which are not available from the City of Somerville's Building Department.	<ul style="list-style-type: none"> ▶ Our preliminary foundation design provides flexibility based on the expectation that obstructions may be encountered. ▶ We will also have appropriate tools and equipment available, at the site. ▶ In addition, GLX Constructors will pre-clear areas, in particular the VMF, in preparation for pile driving operations to expose potential areas of concern early and mitigate any potential issues prior to becoming an impact.
3	Differing Site Conditions	The variability of the bedrock elevation and quality of the bedrock	In addition to the naturally occurring variability, there are several instances where the borings in close proximity to one another were prepared by different geotechnical engineers, and indicate very different ground conditions, potentially impacting deep foundation element installation.	<ul style="list-style-type: none"> ▶ We have already analyzed boring information to identify trends at the top of bedrock elevation and the quality of the bedrock. ▶ We have included provisions for performing supplemental borings in critical areas where drilled shafts are required. ▶ We have adopted driven pile foundations for Piers 8 through 24 of the viaduct to mitigate rock quality issues (piles will take up in soils above the bedrock in many cases). ▶ Additionally, driven pile avoids uncertainty of weathered rock due to pile testing. We will have appropriate tooling and equipment available at the site to deal with obstructions.
4	Differing Site Conditions	Limited subsurface information along some of the proposed retaining walls	Due to access limitations, borings were not performed along the alignment of several retaining walls. Therefore, we expect ground conditions to vary from those inferred for adjacent borings.	<ul style="list-style-type: none"> ▶ We have used conservative preliminary design sections at these wall locations. ▶ We will perform additional borings prior to final design to accommodate for prevailing conditions early. ▶ This approach will facilitate an accurate design that can be completed early or on time to avoid schedule impacts.
5	Differing Site Conditions	Reliable Information regarding levels of soil contamination at the ROW		<ul style="list-style-type: none"> ▶ GLX Constructors has performed extensive hazardous materials due diligence during the proposal phase. ▶ We first identified all recorded soil and groundwater contamination along the entire Project corridor. ▶ We then developed an interactive web mapping tool of all data points to show probable soil conditions linked to associated disposal categories. ▶ Using this information, we have been able to pre-characterize the ROW soils that will be excavated and have incorporated it into our design to maximize the reuse of contaminated soils as backfill material on site. ▶ Additionally, we raised the VMF site elevation and included ATC 35 (changes to portions of the Viaduct Structure to an earth-filled MSE Wall Structure) to provide an opportunity for reuse of appropriate soil. ▶ These approaches maximize reuse of excavated contaminated material on-site versus off-site; thereby, reducing both costs and risks of unnecessary transport of material for off-site disposal.

“
The MBTA's Greenbush Commuter Rail Project included many sensitive environmental elements, including the clearance, site preparation, the handling and removal of contaminated materials, installation of trackside drainage, retaining walls, and fill throughout the corridor. The 18-mile-long corridor was constructed through areas of wetland and intense environmental sensitivity that required significant mitigation. It also passed through many urban communities often behind private residences and across major surface streets, requiring a constant awareness and vigilance to the needs of these communities and traffic patterns.

With the support of STV, Balfour Beatty provided support to the prime contractor to ensure environmental compliance throughout the project duration.



Our success in working near an active track within an urban environment with a limited ROW can be attributed to building healthy partnering relationships throughout design and construction on each project. Fluor and Balfour Beatty's work on portions of the Eagle P3 Commuter Rail Project in Denver, Colorado occurred adjacent to BNSF and UPRR freight rail corridors.

Design and construction considered requirements associated with freight railroads, such as clearances between OCS poles and freight railroad tracks, electromagnetic compatibility with freight railroad communications and signal system, and protection screens and bonding of existing railroad bridges. Portions of construction and installation work were adjacent to Class I ROW. In addition, this team coordinated the design and construction of the shared at-grade crossings with UPRR. This involved joint applications to the PUC, establishing interconnectivity between UPRR and the Fluor- and Balfour Beatty-led team signal houses and city traffic systems, and joint testing and commissioning of the crossings in the field.

#	Risk	Description of Risk	Additional Risk Details	Mitigation Plan/Strategies
6	Working Near An Active Track	Working near an active track	Mitigate and minimize risks of working near an active track through a depth of experience and current working relationships.	<ul style="list-style-type: none"> ▶ GLX Constructors will draw upon our team's personnel expertise and vast experience on past projects working near an active track. <ul style="list-style-type: none"> ◆ We have a depth of experience with railroad owners – in particular, Keolis, Pan Am, CSX, Amtrak, and the MBTA. ▶ We will leverage our established relationships, experience, and knowledge to facilitate communication, coordination, and approvals with the railroad operations. <ul style="list-style-type: none"> ◆ It is a significant benefit to the MBTA that all GLX Constructors' team members have worked on multiple, major infrastructure projects involving work adjacent to, or in, passenger and Class I freight railroad right-of-way (ROW). ◆ By successfully executing these projects, we have demonstrated our understanding of the requirements for safe and efficient construction projects of this size and complexity. ◆ To the extent we are able; we are committed to maintaining service for the MBTA's passenger and freight rail lines. ◆ Our past projects have all required diligent coordination with multiple third parties, interface with the project Owner's active rail lines, and work around other operating, active rail lines. In discussions pertaining to ROW used for freight service, it is critical to properly coordinate and thoroughly understand shared use agreement rights between the MBTA and freight railroads. ▶ Success requires regular, clear, and persistent communication between the freight railroads, the DB Management Team, and the MBTA.
7	Working Near An Active Track	Working near an active track – coordination and permitting	Adjacent railroad stakeholders will be critical to providing information necessary to achieving Substantial Completion. For this reason, these companies will have the priority when we begin early coordination and permitting.	<ul style="list-style-type: none"> ▶ To handle all aspects of railroad coordination, we have appointed Jack Rahmes as our Railroad Coordinator. ▶ Jack will serve as the single point of contact to the railroads, and he will make certain that GLX Constructors clearly communicates with railroad stakeholders throughout the permitting and approval process. ▶ Holding daily and weekly coordination meetings, Jack will remain dedicated through the Construction Phase to keep the MBTA, Keolis, Pan Am, CSX, and Amtrak closely informed about our construction activities and any work that may affect their facilities or operations. ▶ To facilitate working near an active track, our work plans will detail the completion of the day or night shift work activities, which will include sufficient time to inspect the adjacent track to confirm it can be placed back in service. ▶ This inspection will occur with the MBTA's EIC, the MBTA Flagger, and our Superintendent in charge of the associated work. <div style="background-color: #e0f2f7; padding: 10px; margin-top: 10px;"> <p>For the last 5 years, GLX Constructors' team member, Balfour Beatty, has coordinated closely with UPRR on the active Alameda Corridor Transportation Authority (ACTA) Track Maintenance Contract, which involves moving an existing freight corridor between the Ports of Los Angeles and Long Beach and the UPRR and BNSF hubs in Los Angeles into a 30-foot-wide trench.</p> <p>With experience working in a dense, urban corridor, Balfour Beatty has a clear understanding of the coordination challenges and freight railroad requirements necessary for successful execution of safe work within a limited ROW envelope.</p> <p>GLX Constructors team members, Balfour Beatty and STV, worked on the Charlotte Area Transit Systems (CATS) LYNX LRT Blue Line Extension, which included combined right-of-way with the State of North Carolina, CSX, and North Carolina Railroad.</p> </div>
8	Working Near An Active Track	Flagger	Working safely and efficiently around the existing commuter rail, freight rail, and active Green Line tracks requires extensive pre-planning, coordination, effective communication, and great attention to detail.	<ul style="list-style-type: none"> ▶ Our Railroad Coordinator, Jack Rahmes will be actively engaged with planning, notifications, and requests for railroad flagging services. ▶ We will coordinate and establish comprehensive work plans that allow for long-term planning for sufficient flagging resources. ▶ This pre-planning detail will help mitigate schedule disruptions that may occur from any potential shortage of flagging resources. ▶ GLX Constructors' work plans will maximize barriers and barrier fences to minimize the need for flaggers while working in the active ROW. ▶ Our Railroad Coordinator will arrange for flagging at the Track Coordination Meetings and in accordance with the Technical Provisions. ▶ Per the contract requirements, GLX Constructors will develop the construction schedule based on a maximum of 18 flagging resource available on any particular day.
9	Working Near An Active Track	Signal work	Interfacing with adjacent developers and projects is critical to the success of the Green Line Extension DB Project; perhaps no item is more critical than effectively coordinating with adjacent freight and commuter railroads.	<ul style="list-style-type: none"> ▶ Beyond co-locating with the MBTA for daily coordination, we will also employ an aggressive coordination schedule to meet frequently with the MBTA, Keolis, Pan Am, CSX, and Amtrak. ▶ In addition to coordinating construction activities and phasing with ongoing railroad operations, our Railroad Coordinator, Jack, will coordinate track and signal work performed by the Railroad Operator (e.g., Keolis for commuter rail). ▶ Work performed by the Railroad Operator will be over-laid on both long- and short-term Project schedules. ▶ During regular construction coordination meetings, we will review our planned work and its associated timing.

#	Risk	Description of Risk	Additional Risk Details	Mitigation Plan/Strategies
10	Working Near An Active Track	Safety	<p>The safety of the traveling public, community members, and our employees is the most critical aspect of the Green Line Extension DB Project.</p> <p>As discussed in Section 3.1, safety is our Number 1 priority – no priority is higher.</p>	<ul style="list-style-type: none"> ▶ GLX Constructors’ safety culture is based on the highest corporate standards of Fluor Enterprises, Inc., The Middlesex Corporation, Herzog Contracting Corporation, and Balfour Beatty Infrastructure, Inc., whose concepts and practices have been used and tested with successful results on projects throughout the world. ▶ Working near an active track presents unique safety hazards that require customized procedures to mitigate effectively. <ul style="list-style-type: none"> ◆ Communicating safety hazards and procedures is critical to the success of our safety and health training programs. ▶ We will adopt a detailed safety program and culture on the Project from inception. <ul style="list-style-type: none"> ◆ Roadway Worker Protection (RWP) training is required for all workers, which will clearly lay out responsibilities and protocols. ◆ Employee orientation at the Project’s onset includes communication work force prior to construction. ◆ This training will emphasize work areas that are adjacent to live rail and vehicular traffic, with measures that include positive barriers, increased visibility, controlled/designated points of ingress and egress, and flaggers. ▶ We will develop a Project-specific Roadway Worker Safety Protection manual (RWSP), which implements stringent standards that are consistent with federal regulations and aligns with Keolis’ RWSP. <ul style="list-style-type: none"> ◆ Our RWSP will afford on-track safety for all roadway workers whose duties occur on the Project’s property, and it will provide specific levels of protection required by federal law. ◆ Our policy will include procedures to monitor both the effectiveness and compliance with the program. ▶ Rules and operating procedures governing track occupancy and protection are included together in one manual, which will be readily available to all roadway workers. <ul style="list-style-type: none"> ◆ GLX Constructors understands that it is responsible for its employees’ understanding of and compliance with the rules and the requirements of the on-track safety program. ◆ Each roadway worker will be responsible for following the on-track safety program when working on Project property. ◆ A roadway worker will not foul a track except when necessary for the performance of the work. ◆ Each roadway worker is responsible to ascertain on-track safety before fouling a track. ▶ We will implement a Track Access Program, in which work near active railroads must be coordinated between GLX Constructors’ Railroad Coordinator and the Track Access Committee. <ul style="list-style-type: none"> ◆ This coordination will take place during our daily Track Access Committee Meetings. ◆ Preparation will include developing detailed work schedules, plans, procedures, and other information as required by the railroads. ◆ All planned work is subject to approval by the Track Access Committee. ▶ We will strengthen corridor safety by optimizing our design and carefully phasing construction in a way that reduces or eliminates work over active rail and traffic lanes. <ul style="list-style-type: none"> ◆ GLX Constructors will develop detailed Management Plans (e.g., PEP, DQMP, CQMP, SWP3) that include work activity planning and processes, and management structures that achieve quality and compliance to improve safety. ◆ To further increase our safety measures, GLX Constructors will implement and enforce detailed lifting/rigging safety procedures, where no pedestrians or vehicles will be allowed under loads during critical lifts or major construction events that may create a potential hazard to nonconstruction personnel. ◆ We will pre-plan all lifts and develop critical lift erection plans for qualifying lifts, complete with critical lift Constructability Reviews performed by GLX Constructors Operations & Safety. ▶ A structural engineer will design support of excavation systems, with Constructability Reviews performed by GLX Constructors Operations & Safety. <ul style="list-style-type: none"> ◆ As detailed in Section 3.1, GLX Constructors will implement the and training of our Health, Safety, and Environmental (HSE) Plan and philosophy to the Safety Task Assignment (STA) process and incorporate utility location information into the STAs. ◆ We will provide high visibility warning signage and use a utility spotter at all times when working in high-risk areas. ▶ To prevent injury to both the traveling public and Project employees, we will establish and implement a comprehensive Testing and Commissioning Plan. <ul style="list-style-type: none"> ◆ Third parties will be included as part of the development of these procedures. ◆ We will institute a comprehensive public information campaign prior to live testing, which will require outreach and close coordination with places such as nearby residences, businesses, universities, and places of worship. ◆ We will also add additional security and safety personnel during the Testing and Commissioning Phase to enforce HSE protocols, including the Project Security Plan, which is a component of the HSE plan.

“
In 2016, the National Railroad Construction and Maintenance Association recognized Balfour Beatty and Herzog with its Platinum Award for excellence in railroad safety after subjecting their safety program and safety practices to a rigorous review.

This award recognizes Balfour Beatty and Herzog’s extensive efforts to promote and improve safety in rail construction.



#	Risk	Description of Risk	Additional Risk Details	Mitigation Plan/Strategies
11	Working Near An Active Track	Maintaining convenience to the public	Maintaining adequate access in and around the Project site is important to minimize inconveniences to the traveling public and to fostering a positive community relationship.	<ul style="list-style-type: none"> ▶ GLX Constructors will perform pre-construction video of all surrounding roads to thoroughly document existing conditions, and to seek agreement on pre-existing condition with local entities and the MBTA. ▶ To reduce congestion, improve safety, and limit wear on local roads, GLX Constructors will use off-road hauls when possible. ▶ Our design and construction approach has minimized heavy hauling on local roads. ▶ We will carefully plan our major construction access activities that might interact with local event days, such as the Boston Marathon on Patriot's Day, Evacuation Day, Bunker Hill Day, other sporting events, or local municipality event days. ▶ Our Title VI Program Lead will communicate with the MBTA and appropriate third-party stakeholders to provide this input to our planning and scheduling team
3.4.C. Impacts to Adjacent Properties and the Traveling Public				
12	Impacts to Adjacent Properties and the Traveling Public	Minimize impacts through proactivity, public engagement and awareness	It is critical to the Project's success to maintain an excellent reputation for the MBTA, GLX Constructors, and affiliated companies and maintains positive impressions from the community.	<ul style="list-style-type: none"> ▶ In our partnership with the MBTA, GLX Constructors will involve the local community through sponsored information sessions throughout the Project's life to solicit feedback and identify improvement opportunities for stakeholder involvement. ▶ We will engage local agencies and stakeholders through our TWGs and ad hoc meetings during the planning stages of both design and construction, so we may address concerns early and adequately. <ul style="list-style-type: none"> ◆ To establish and maintain positive community impressions, we will emphasize the importance of minimizing impacts to adjacent properties and the traveling public. ▶ Understanding the right-of-way limits, the surrounding neighborhoods, and nearby businesses is critical to minimizing impacts to properties that are adjacent to the Project. <ul style="list-style-type: none"> ◆ Our workers will walk construction work zones prior to construction to familiarize project staff with the Project's right-of-way. ◆ We will define access points during post-award planning. ◆ To encourage their use, enhance safety, and minimize confusion, points of ingress/egress will be clearly marked with orange construction entrance signage. ▶ As part of our planning process, we will know the working hours in each jurisdiction and engage in an active community outreach program. <ul style="list-style-type: none"> ◆ We will meet with local businesses in particular work zones to provide updates and familiarize ourselves with their concerns and issues. ◆ Additionally, GLX Constructors will execute our work per the approved work plans and permits (e.g., environmental compliance and night work) and closely monitor noise and vibration attributable to on-site construction activities. ◆ Further, our design minimizes driven pile foundations in favor of noise- and vibration-friendly drilled shaft and micro-pile foundation types. ◆ To document existing conditions prior to the start of construction (e.g., nearby building foundations), GLX Constructors will hire a specialized firm to perform pre-construction surveys, which will include video as necessary. ▶ To prevent potential damage during construction to adjacent historic properties and cultural resources found in the Pre-Construction Survey, we will develop a Comprehensive Environmental Protection Program (CEPP) for the project, per the contract, to include protocols for protecting known historic properties and cultural resources. <ul style="list-style-type: none"> ◆ GLX Constructors will implement a detailed CEPP on the Project from its inception, with training that includes clear responsibilities and protocols. ◆ We will identify known historic and cultural sites/non-disturbance limits in the plans, and fence/protect-in-place known sites prior to the start of construction activities. ◆ Our Environmental Manager, Chris McDermott, will also monitor known historic/cultural sites, and in the event a historic/cultural site is damaged, crews will stop work in the immediate area, create a safe buffer, and notify the Environmental Manager. ▶ To minimize impacts to the traveling public, we will develop comprehensive Track Access and Maintenance of Traffic (MOT) plans, and schedule work to minimize rail/lane impacts (e.g., by using allowable track windows, night, and weekend work). ▶ We will also develop comprehensive work plans to eliminate the need for unplanned rail/lane closures. <ul style="list-style-type: none"> ◆ By coordinating with and obtaining approval from the MBTA on the proposed schedule for all full closures, we will develop hour-by-hour schedules, including an additional 30-minute buffer to provide maximum planning for all such events. ◆ As an extra measure of insurance, we will develop contingency plans for all partial and full rail/lane closures. ◆ In our experience, effectively communicating lane closure requirements to all subcontractors and inspectors enhances their performance.

#	Risk	Description of Risk	Additional Risk Details	Mitigation Plan/Strategies
---	------	---------------------	-------------------------	----------------------------

3.4.D. Other Major Risks

13	Schedule	Schedule certainty	Delivering schedule certainty begins very early in the process through a robust understanding of the Project, and continuous engagement of interdisciplinary teams of subject matter experts and key stakeholders in a formal, collaborative structure, i.e., Technical Working Groups, to collectively mitigate and minimize potential and actual schedule impacts.
----	----------	--------------------	--

- ▶ GLX Constructors have developed a detailed construction schedule based on our initial design.
- ▶ We have included input from our Design Team, Construction Team, Environmental Team, local subcontractors, and our DB Management Team.
- ▶ We have reviewed safety concerns and modified design and construction procedures where necessary.
- ▶ By properly including our Construction Team into our Design Team's Technical Work Groups, we have streamlined our design's review and approval process.
 - ◆ This approach to construction-driven execution adds certainty that we will achieve faster startup of construction activities, taking advantage of as much of the 2018 construction season as possible.
- ▶ Utility relocations and their associated designs have been identified and scheduled for early works design and construction to mitigate potential impacts to the Project's DB Schedule.
- ▶ We will develop detailed early work design schedules for execution and construction, allowing the MBTA and appropriate third-party stakeholders' adequate time to react and plan.
- ▶ After Project Award, we will begin coordinating and proactively partner with local cities and stakeholders for optimal night work windows, which will help mitigate schedule impacts and lessen the burden to local communities.
 - ◆ We will train all workers in accordance with the requirements of each jurisdiction impacted by night work operations and their associated noise control plans.
- ▶ The original baseline schedule is produced on the Primavera P6 platform, and we have also evaluated our construction resources using Time Location Diagram software, TILOS, to highlight areas of heightened concern for resource allocation, including flagging resources.
- ▶ GLX Constructors performed a Primavera Schedule Risk Analysis to assess the schedule, progress, and budgetary impact of risks associated with each Project component, and the output shows the probabilistic likelihood of achieving particular major milestones
 - ◆ A schedule risk analysis calculation has been performed generating a P85 confidence level of achieving the required milestone dates, as shown in the graph below.

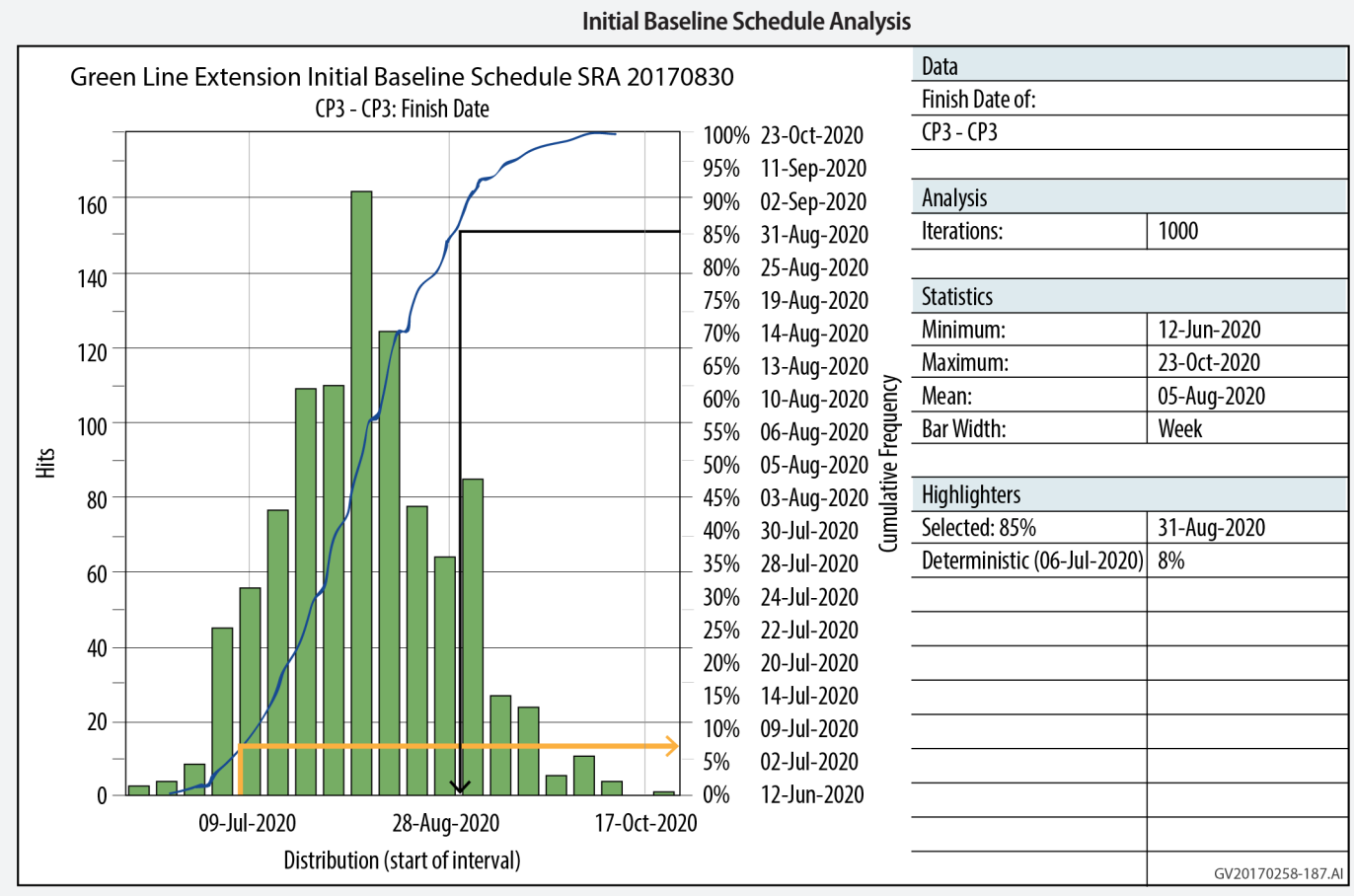

“
Our construction team is well-versed in accelerating construction to avoid rail closures.

For example, on the Utah I-15 CORE Highway Design Build Project, GLX Constructors' team members used Accelerated Bridge Construction (ABC) to expedite the schedule. Under this ABC method, four bridges were constructed on the side of I-15. With the use of a remote-controlled, self-propelled modular transporter, the bridges were swiftly moved into place overnight, allowing for only a single-night full freeway closure – without affecting the safety or travel times of motorists using the interstate.



#	Risk	Description of Risk	Additional Risk Details	Mitigation Plan/Strategies
14	Utility Risks	Effectively managing several high-risk utilities that lie within the Project corridor	Spectra Energy Algonquin's (now Enbridge) gas line at STA 266+50; the MWRA 12" waterline and Verizon ductbank at Medford Street; the at-grade ductbank, waterlines, and sanitary sewer lines at School Street; and the water, electrical, and communication lines at Broadway. Relocating these utilities will have long durations and coordination will involve long lead times, as discussed in Section 4.9.	<ul style="list-style-type: none"> ▶ GLX Constructor's design approach includes adjustments that minimize the impacts to utilities, leaving them, in-place where possible. ▶ Our Utility Coordinator will be the main point of contact between GLX Constructors, the MBTA, and Utility Owners, and we will leverage our previous experience and relationships with MWRA, Enbridge, Verizon, AT&T, and others throughout the Project limits to help expedite reviews and approvals. ▶ GLX Constructors will maintain a good working relationship with all Utility Owners and will comply with each Utility Agreement and its Project Execution Plan (PEP). ▶ The Utility Coordinator will develop, manage, and update the Utility Coordination Plan (UCP), and will organize coordination meetings to identify, clarify, and resolve issues. ▶ Utility coordination will take place immediately after Project Award to minimize schedule impacts. ▶ Early coordination will include identifying and confirming utility locations, potential conflicts, and required relocations. ▶ As part of this process, we will develop a utility relocation and new service matrix to identify relocations, required easements, new service delivery points and routings, utility test pits, and costs associated with relocations. ▶ Sharing information with Utility Owners early on will reduce problems arising from an inadequate available Subsurface Utility Engineering (SUE) level, including risk of an accidental utility strike by crews working in close proximity to existing lines and infrastructure. ▶ The UC will prepare Utility Agreements, PEP documents, and maintain a Project utility composite map, showing existing and proposed utility alignments, and an issues status log. ▶ The UC will also develop action plans and schedules to control and monitor execution and compliance with the respective PEP. ▶ We will maintain ongoing communication with utility companies so that design and construction of relocations is performed in an efficient, cost-effective, and constructible manner to the Utility and MBTA Standards. ▶ To accelerate utility relocations, we will use special utility designers approved by the Utility Owners. ▶ If required, we will update and reissue the UCP to address changes in site conditions and Project scope. ▶ GLX Constructors will execute any necessary agreements with Utility Owners, and we will perform the design and construction of the utility relocation to minimize risk. ▶ In the event that we encounter an unidentified utility, we will perform a Utility Adjustment Amendment to accelerate the relocation process if a Utility Agreement is already in place with the owner of the unidentified utility.
15	Public/Media Exposure	Maintaining rider satisfaction	Maintaining rider satisfaction, as well as convenience to the public, during the construction of the Green Line Extension DB Project is essential to us.	<ul style="list-style-type: none"> ▶ GLX Constructors understands the importance of not disrupting train schedules, particularly in a congested, urban area. ▶ We will reduce public inconveniences through design optimization and careful construction planning that streamlines cutover/tie-in activities and accelerates the work. ▶ We will coordinate with and obtain approval from the MBTA on the proposed schedule for all full closures to support cutover/tie-in operations. <ul style="list-style-type: none"> ◆ We will develop detailed cutover/tie-in plans that are realistic and achievable within the allowable outage windows and provided time constraints. ▶ Detailed planning will include developing hour-by-hour schedules for all cutover/tie in events, including an additional 30 minute buffer for demobilization. ▶ As an extra measure of insurance, GLX Constructors will also develop contingency plans for all cutover/tie-in events.
16	Public/Media Exposure	Public awareness and outreach	Maintaining public awareness with extensive outreach to communicate project status and mitigate public concerns/issues during construction.	<ul style="list-style-type: none"> ▶ GLX Constructors' Title VI Program Lead, Hannah Brockhaus, and her team will support the MBTA on public and media exposure events, whether planned or unplanned. ▶ Our approach is to identify potential exposure during the initial design evaluation and assemble an event specific plan or approach for dissemination to the public and media.

The Green Line Extension DB Project has unique technical, public relations, and logistical challenges. It presents potential Projects risks that must be actively managed for the Project to be successfully delivered on time and within budget. These include, but are not limited to:

Mobility and Safety. The Green Line is a highly congested, active commuter, passenger and freight rail corridor, and a gateway to visitors who enter the city for special events. Therefore, the Project demands advanced track allocation/access management, maintenance of traffic, construction planning, sequencing, scheduling, and communications/SCADA, signals, systems, and ITS management to protect the safety and mobility of the public before, during, and after construction.

Third-party interfaces. The biggest risk to on-time completion lies within third-party interfaces and utilities such as MWRA, Enbridge, Verizon, and AT&T. These stakeholders and their requirements must be well understood and built into our plans and schedule in advance.

Environmental. Cambridge, Somerville, and Medford are Environmental Justice communities that pride themselves in environmental stewardship. The Green Line Extension DB Project will result in significant air quality improvements in the region's most densely populated community.

We are committed to completing the Green Line Extension DB Project on time and within budget. We sincerely understand the critical nature of these requirements – many of us live here, and we have successfully completed other infrastructure Projects in the area.

To make certain these challenges were known, properly addressed, and built into our plans, price, and schedule, we have assigned a group of highly experienced staff to develop a detailed list of potential Project risks and their associated mitigation measures. We have invested an extensive amount of time into due diligence, including detailed meetings with key stakeholders to make certain we fully understand the Project's implications, challenges, and requirements. As a result, GLX Constructors is prepared for a rapid, efficient, and successful start to the Project, focused from the first day on the MBTA's Project goals.

3.5 INITIAL BASELINE SCHEDULE

Since our SOQ submittal in early 2017, GLX Constructors has invested tremendous resources in the pursuit of the Green Line Extension DB Project. In developing our proposal, we have performed schedule analyses to fully assess the design and construction challenges of the Project. While performing these activities, we focused on the MBTA's milestones, objectives, and activity restrictions. In establishing our Initial Baseline Schedule, we have coordinated the scope of all Project-related activities to safeguard schedule certainty, identify potential risks, and implement appropriate mitigation measures to address concerns from the MBTA and local municipalities.

The Project's schedule is at the core of Project execution, and it must be continuously monitored to make certain that work is performed within the established time allotted. As it is with all schedule preparations, the Project Team's input and active participation is essential. GLX Constructors will make certain that the Project Team – comprising the Superintendents, Project Controls Team, and DB Management Team – is the principal driver for developing and maintaining the Project Schedule from Notice to Proceed 1 (NTP 1) through Final Acceptance.

GLX Constructors' Scheduling Team works closely with our engineers, managers, and designers to create and maintain the most achievable, aggressive schedule for the Green Line Extension DB Project. We have evaluated and included considerations for potential needs and impacts of local residents, the traveling public, the environment, weather, and other anticipated events to produce an achievable Initial Baseline Schedule. We have accurately determined the baseline construction period, and we commit to the completion of each required milestone while maintaining minimal inconvenience to the public.

3.5.A GLX CONSTRUCTORS' UNDERSTANDING OF DESIGN PHASE AND CONSTRUCTION PHASE PLANNING

Our Initial Baseline Schedule is a construction-driven Critical Path Method (CPM) schedule developed as a collaborative effort by all Project disciplines, including our Lead Designer, STV, and relevant subconsultants. During the Proposal Phase, GLX Constructors collaborated in our Technical Work Groups (TWG) to develop the Initial Baseline Schedule and include initial design concepts. These TWGs will continue during the DB phase of the Project, during which the schedule will remain a critical, primary topic of discussion. We will regularly review and update the schedule to meet the MBTA's goal to achieve schedule certainty.

Included in our Initial Baseline Schedule is our Design Team's input for the Design Phase of the Project. The Design Team is committed to completing the design activities in a timely manner to support the overall Project

Schedule. Each step of the Design Package (30/60/90/RFC, as illustrated in Figure 3.1-12 in Section 3.1, Project Management Plan) has been included in the Initial Baseline Schedule, as well as appropriate QA/QC, constructability, the MBTA, and third-party review timelines.

Receiving the Ready for Construction (RFC) drawings initiates construction activities. We have evaluated the construction activities with our principal estimators, construction superintendents, and DB Management Team to make certain the construction activities' depictions are accurate. We have allotted time in each construction activity for QA/QC inspection and approval, which allows for proper work documentation.

After construction activities are complete, the Testing and Commissioning Phase of the Project commences; we have included aggressive, achievable timelines for the completion of this work in the Initial Baseline Schedule. Our Systems Team, composed of design and construction personnel, has collaborated to confirm the proper amount of time needed for testing, commissioning, certification, and rail activation before revenue service begins.

3.5.B GLX CONSTRUCTORS' UNDERSTANDING OF HOW THE CRITICAL PATH METHOD WILL BE UTILIZED

Our Initial Baseline Schedule, which comprises the integrated design, procurement, construction, and testing/commissioning schedules, includes a fully integrated CPM schedule that identifies critical design packages and long-lead procurement items that support our initial construction activities. By integrating design, procurement, construction, testing, and commissioning activities into a single CPM schedule, the critical path schedule incorporates all necessary elements and displays the float to the specific activity, rather than design, procurement, or construction as a whole.

Our critical path determines the duration of the longest path from Project Award through Contract Final Acceptance, and it does not contain arbitrary resource ties. The activity and logic ties show all required work sequentially; the logic ties define all tasks related to the MBTA or third parties. We have determined our critical path by pure construction logic.

All activities, with the exception of the Project Start and Completion milestones, are logically tied without using Start-to-Finish relationships. No unrelated or interim dates are used to influence any float values. The total float value is initially determined by NTP to Milestone 4A, then from Milestone 4A to Milestone 4B, then to the Contract Final Acceptance. The longest path with the least float value (0 days) defines the critical path from Design to Construction to Contract Final Acceptance.

We will use the critical path schedule during contract execution to highlight the activities where potential delays may occur without mitigation efforts. In addition, we will highlight any schedule paths that are near critical, five days or less of float, to identify other schedule areas that may require mitigation.

The critical path activities that determine our baseline Construction Phase are shown in Appendix 2 – Initial Baseline Schedule Critical Path.

3.5.C GLX CONSTRUCTORS' UNDERSTANDING OF THE MBTA'S REQUIREMENTS

During the Proposal Phase, GLX Constructors carefully reviewed the RFP and associated documentation. Our thorough understanding of the MBTA's requirements is clearly demonstrated by our schedule submittal, which includes:

- ▶ A complete CPM.
- ▶ A resource-loaded schedule to include a sample figure of \$100 million.
- ▶ Effective logic showing all responsibility designations and durations.
- ▶ Sample cash flow report.
- ▶ Complete outline of the schedule coding.
- ▶ A complete production rate basis table.
- ▶ A work breakdown structure (WBS) depicting the MBTA's mandatory codes, with additional codes added to enable GLX Constructors to further filter through and analyze the data.

3.5.D GLX CONSTRUCTORS' INNOVATIVE APPROACH TO THE WORK

Our Initial Baseline Schedule incorporates all approved ATCs. In addition, our schedule has been integrated with a time-location diagram using the program TILOS®. This innovative diagram linearly depicts the entire construction of this Project segment in a cohesive, one-page format, as exemplified in Appendix 3 – TILOS Schedule for Union Square Line and Appendix 4 – TILOS Schedule for Medford Line.

As illustrated in Figure 3.5-1, a snapshot of the TILOS schedule for Medford Line, the left side of the diagram depicts the time scale of the Project, and the top section shows the linear segmentation of the Project. As a benefit, the time-location diagram conveniently shows the location of all construction activities, as well as their time frames in a linear fashion.

Through carefully analyzing the TILOS diagram, crew density, and productivity rates, the simultaneous construction activities demonstrate potential constructability and conflict issues long before construction



The innovative use of Herzog's Multi-Purpose Machine (MPM), gondola cars, flatcars, and low-railers will allow GLX Constructors to avoid congestion in the corridor by shuttling materials and equipment into and out of the work areas during off peak hours. Because of the low profile of the cars, equipment can be easily transported to and from the corridor, and work operations can be performed from low-rail mounted equipment.

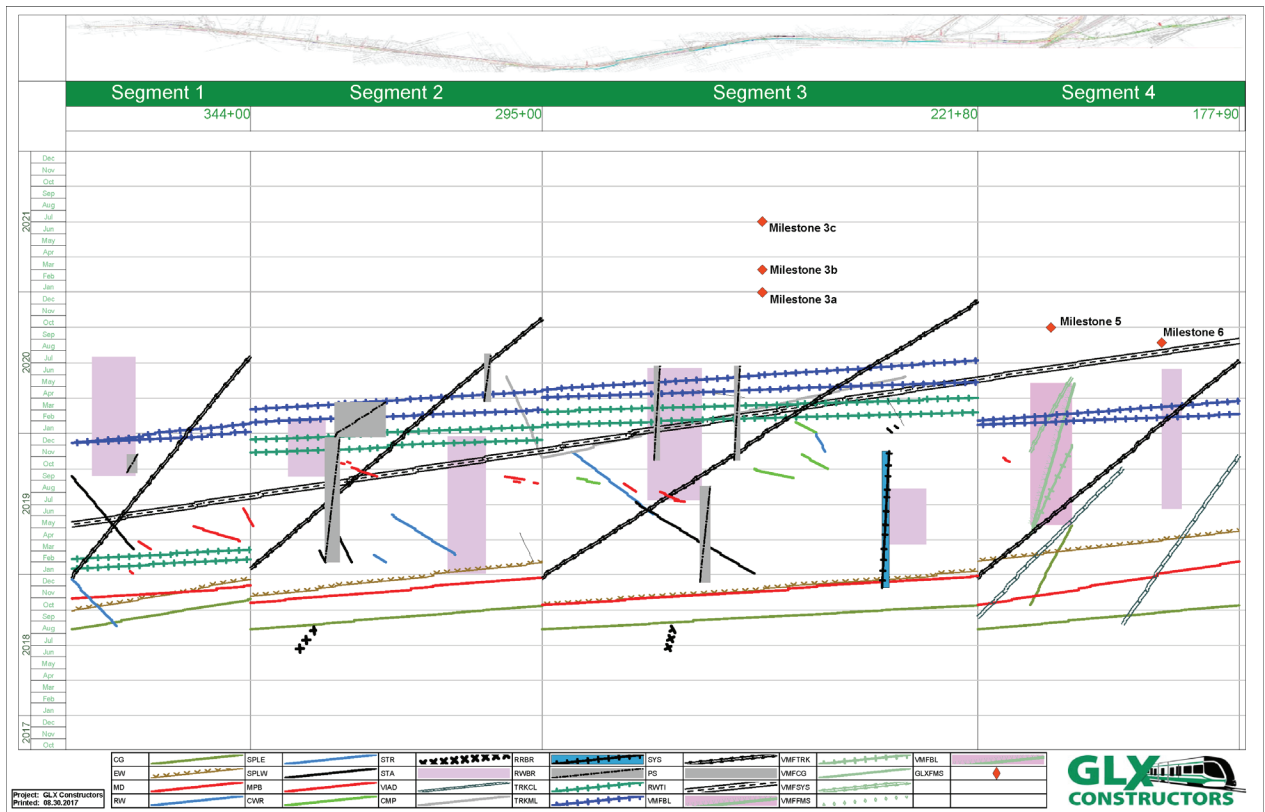

Figure 3.5-1. TILOS Example. GLX Constructors will use TILOS to demonstrate the entire construction of the Project in a cohesive, one-page format.

begins. This information is seamlessly integrated with our Primavera schedule for simple import and export functionality.

This integration allows us to perform constant, real-time analysis of our Project schedule and adjust, as necessary, to protect an on-time Project completion.

Innovative Rail Techniques

Our team will eliminate, or overcome, many of the risks associated with the constricted work zones by using Herzog’s proprietary rail equipment. We believe our capabilities and experience in using this equipment will vastly reduce risk to GLX Constructors and the MBTA to successfully complete the Project on or ahead of schedule. During preconstruction, we will use hy-rail light detecting and ranging (LiDAR) trucks to create a 3D model of the corridor features to confirm elevations, clearances, and spatial relationships.

LiDAR Imaging

Herzog’s specialized LiDAR trucks can produce in-depth laser scans for horizontal and vertical geometry of the ROW in an electronic file format, which is able to be directly uploaded into our design software programs as needed. The LiDAR information allows us to provide information to the



On the DCTA A-Train Project, ballast was brought in and was stored in several locations along the alignment. Once sufficient track was constructed, our team used Herzog's 300-ton capacity ballast train to dump ballast down the track, making the placement process more efficient. For areas with subgrade, the ballast trucks placed ballast directly onto grade, followed with a blade to smooth and level out the ballast. Bottom ballast was trucked directly to the jobsite.

Design Team in real-time, and it allows more efficient and effective design and construction work planning.

Multi-Purpose Machines (MPMs)

MPMs, designed and built by Herzog, enable us to perform work activities including excavation, utility installation, wall construction, pile installation, signal installation, and other track construction needs directly from the existing track, during available work windows, using the MPM as a mobile work platform. Other equipment, including flatcars powered by Track Mobiles for delivering bridge materials and station components, ballast cars for placing ballast, low-railers, and hy-rail trucks for delivering materials and personnel, will be used to minimize the need for at-grade access from local streets.

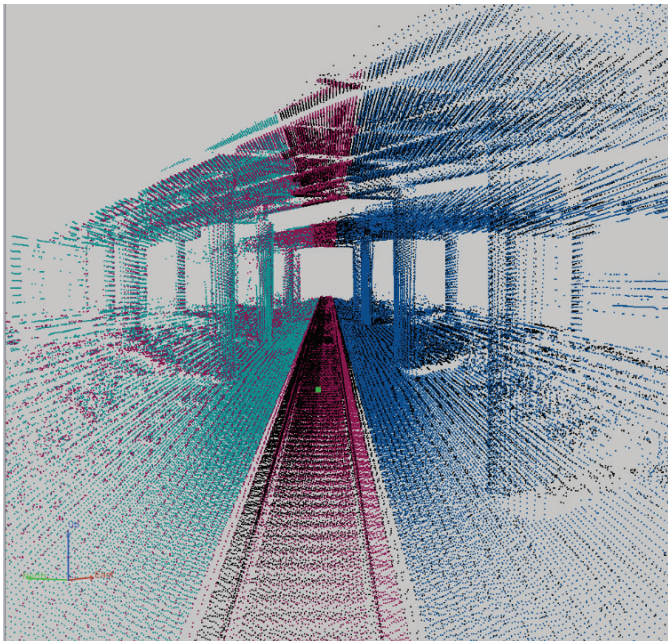

Figure 3.5-2. LiDAR Imaging Example. GLX Constructors will use Herzog's LiDAR Imaging technology to meet or exceed our schedule's critical path activities by allowing for quick information processing and more proficient construction work planning.

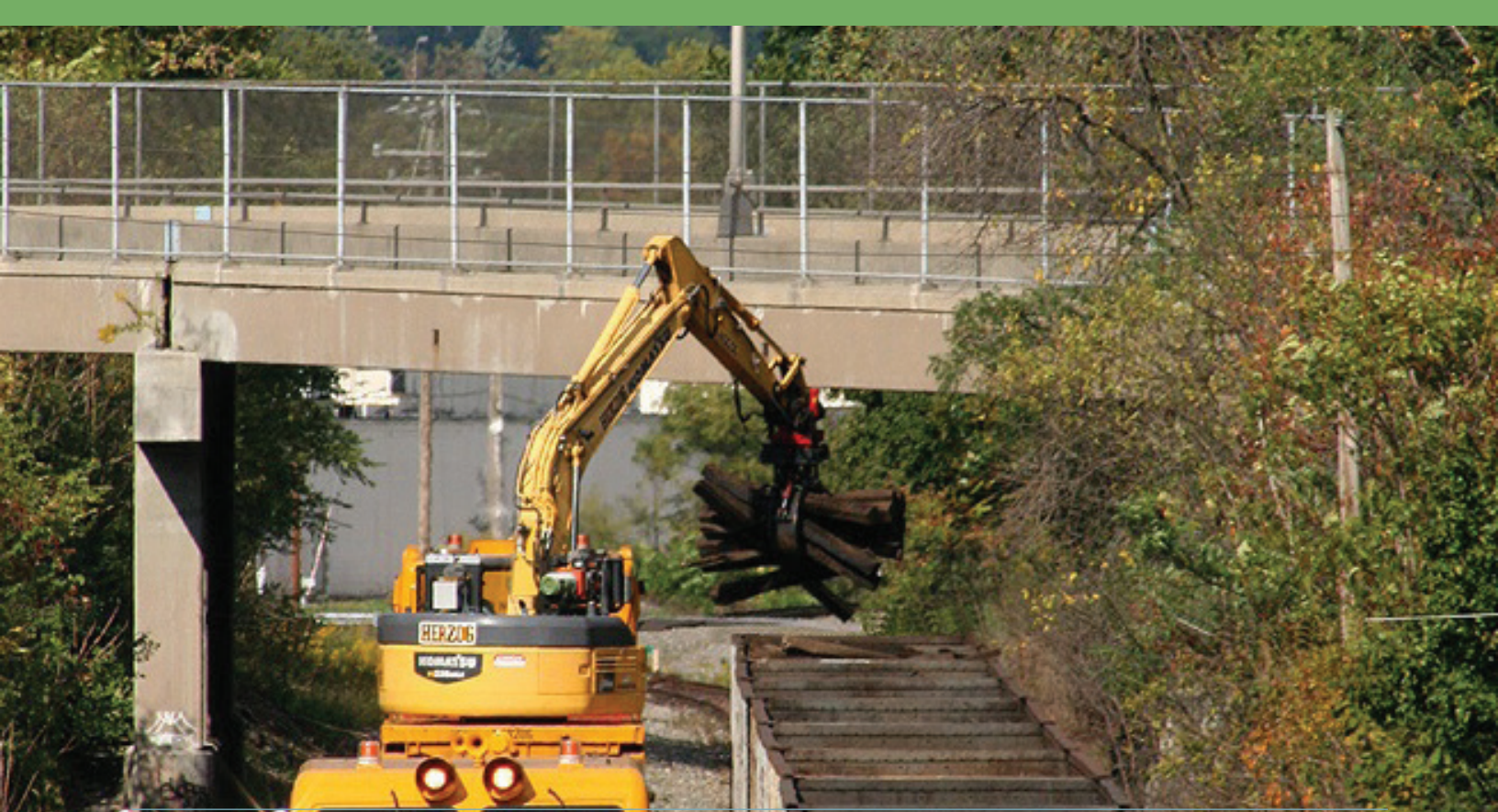

Figure 3.5-3. An Example of a Multi-Purpose Machine. Using Herzog's MPMs will allow GLX Constructors to remain on schedule, even in the case of potential, unexpected delays. This poses a sincere benefit to the MBTA and the public realm.

3.5.E GLX CONSTRUCTORS' APPROACH TO MANAGING INTERFACES

To successfully deliver a Project of the scope, size, and complexity as the Green Line Extension DB Project, managing interfaces is critical to have a seamless transition from the Design Phase to the Construction Phase of the Project. We have kept this critical transition in mind during the Proposal Phase, and we intend to mirror the same focus during the Execution Phase of the Project.

For example, we have developed the Project's Design Schedule to accommodate for the field's needs, such as procurement or testing and commissioning, interfaces demonstrated in Figure 3.5-4. We will schedule our earliest submittals to provide adequate procurement and construction times for the work items that define our critical path



The benefits of the MPMs were demonstrated on the Southwest Rail Line Project in Denver in 2008. Herzog was asked to assist in the cleanup and reconstruction after the derailment of freight cars in a shared freight/light rail corridor damaged several hundred feet of LRT track, walls, catenary poles, and associated improvements. To avoid the need to reconstruct the undamaged outbound LRT line, a track-based repair solution was required. Mounted on one of three Consolidated Mainline freight tracks and working under a Form B Order, MPMs worked in support of our construction crews to remove and rebuild the MSE wall, track, and other improvements in just 11 days. Our ability to work from existing commuter/freight tracks is a distinct advantage GLX Constructors offers the MBTA.

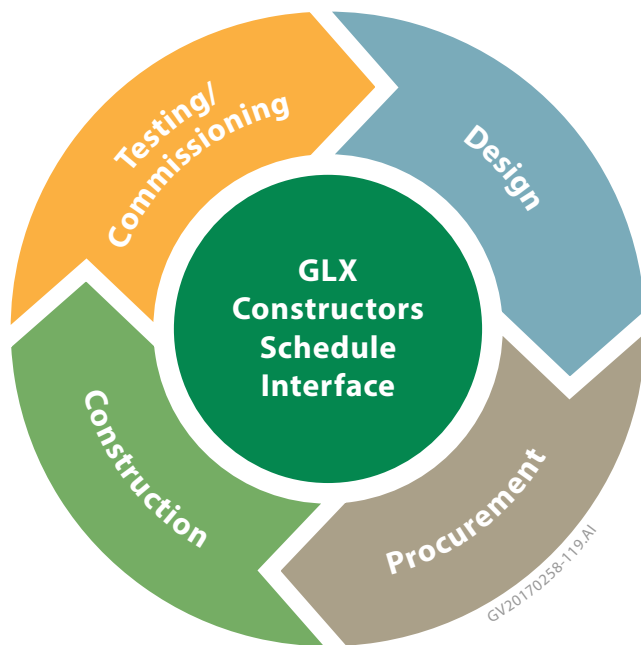

Figure 3.5-4. GLX Constructors’ Schedule Interfaces. *To smooth the transitions between each critical Project Phase, our schedule takes into account information from design, procurement, construction, and testing and commissioning, which facilitates an efficient DB execution.*

Our construction project engineers interface with the Design and Scheduling Teams during the Design Phase to provide constructability, schedule reviews, and mitigation efforts. During the Project’s Construction Phase, our project and field engineers will work with the Design Team to mitigate and resolve construction issues as they arise.

Similarly, our Scheduling Team interfaces with Construction and Procurement Teams when the design solution requires procuring materials and resources. These requirements are identified during the Design Phase and quantified by our project and field engineers to determine the procurement activities necessary to properly supply the materials. In turn, the procurement information is provided to the Scheduling Team to update the schedule accordingly.

3.5.F OTHER KEY ASPECTS OF SCHEDULE PROGRESSION AND CONTROL

Effective resource management is urgent to the success of a DB project. Our Project Manager, John West, and Construction Manager, Jamie Doyle, will lead GLX Constructors’ resource management on a day-to-day basis. Our Project Controls Manager and Lead Scheduler will assist John and Jamie and maintain progress to look for early symptoms of schedule slippage.

For cost certainty and timely Project execution, GLX Constructors will determine the resources required and plan accordingly. We will develop

“
On multiple DB projects, our team members have repeatedly proven that we are capable of managing interfaces, working together as designers and builders to execute projects that meet or exceed our clients’ needs and expectations.”

action plans for directing and controlling resources of workers, equipment, and materials in a coordinated and timely manner.

When managing our Project resources, we will consider all scheduling activities, ranging from the daily adjustments necessary to keep a project running efficiently, to formally submitting a recovery schedule if required. By planning the Project with the foresight to schedule work on multiple fronts concurrently by various Project disciplines, we create the schedule flexibility to offset delay in one area by moving crews to other locations with minimal lost time. We can then focus on resolving the issue that is delaying one phase and, when it is resolved, recover the schedule by adding resources to complete the delayed activities.

Because schedule slippages can cause the critical path to shift, we will conduct weekly reviews of the critical path to help the Lead Scheduler and DB Management Team understand how priorities need to be modified. Action items developed during the schedule review meetings can include steps such as securing additional resources and material, shifting resources to other areas, initiating night shifts, or meeting with suppliers to update fabrication or delivery schedules.

Enforcing resource objectives is driven by close supervision, monitoring of progress against an updated plan, and escalating issues as necessary. See Section (w.) below for more information.

Overcoming Schedule Execution Challenges

On the Denver Eagle P3 Project, executed by Fluor, Balfour Beatty, and STV, there were numerous Schedule Execution Challenges that our team members overcame.

- ▶ **IDC Retrofits.** Designs for the bulk of already constructed bridge structures were determined to be noncompliant with AREMA per the Concession Agreement less than two years prior to the project's Revenue Service date. Resolutions varied from complete bridge demolition and replacement to field retrofits of various degrees, impacting a total of 15 bridge structures at a total cost of \$25 million. All bridge structure remedial work was completed and the ensuing OCS and Train Control systems installation was compressed into 50 percent of the original schedule timeframe without delay to Revenue Service.
- ▶ **Third-Party Coordination.** Coordination and schedule challenges with a significant number of various third parties that maintained design acceptance authority within their jurisdiction, including DIA, FRA, multiple Denver area cities and counties, BNSF and UPRR railroads, Colorado PUC, and multiple utility companies involving approximately 1,000 conflicts.

► **Client Changes.** Over 180 client changes that modified the project scope by a value of 25 percent. Late client changes to the alignment less than two years prior to the project’s Revenue Service date included the addition of a station and significant lengths of railway corridor protection barrier.

► **Rolling Stock Procurement.** Major rolling stock procurement of an original 50 vehicles with a client change for an additional 16 vehicles within two to three years of the project’s Revenue Service date. All 66 rolling stock vehicles were scheduled and managed to on-time delivery in support of the Revenue Service date and ensuing operations period.

3.5.G MEASURE OF HOW MUCH WORK REMAINS TO COMPLETE AN ACCEPTABLE BASELINE SCHEDULE SUBMISSION AFTER NOTICE TO PROCEED

After Project Award and the Initial Baseline Schedule submission, GLX Constructors will conduct a schedule planning session with the MBTA to begin creating a more detailed design and construction schedule. We estimate our current schedule is approximately 30 percent complete in the level of detail that will ultimately be developed.

We will continue to develop the remaining detail as the permanent design progresses and completes, allowing for more clearly refined and updated construction activities. The Project schedule will be a living document as it progresses through the discipline interfaces in an update – progress – refine – update cycle, as illustrated in Figure 3.5-5. From this planning session and by expanding the current Initial Baseline Schedule, GLX Constructors will work with the MBTA to further develop the Baseline Schedule rev. 0.

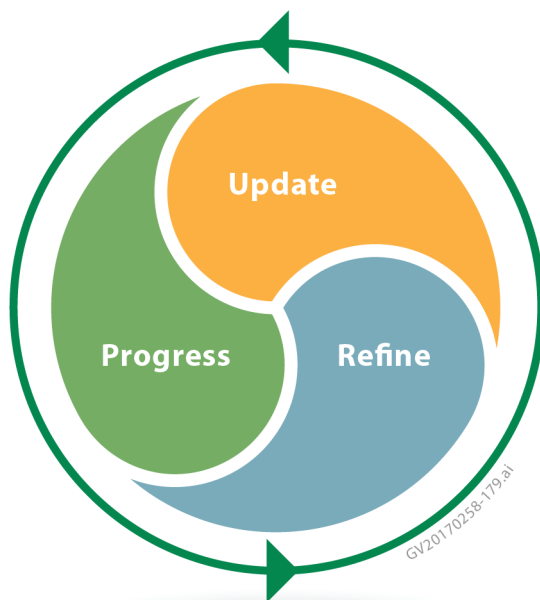

Figure 3.5-5. Cycle to Refine the Project Schedule. *Our Project Schedule is a versatile, living document that will adjust well to the needs and circumstances of the Project.*

Electronic Schedule Submission

The electronic schedule submission is included in our Proposal submission.

Sample Figure Requirements

Our electronic submission is cost-loaded with a sample figure of \$100 million and included in our Proposal submission.

Roll Plan Hardcopy

The 36-inch roll plan hardcopy showing logic ties is included in our Proposal submission.

Sample Reports

The sample reports are included in our Proposal submission.

GLX Constructors' Detailed Narrative Description of our Proposed Project Approach

To properly estimate and develop a proposal for this Project, GLX Constructors has created an Initial Baseline Schedule that comprises design, procurement, construction, start-up testing, commissioning, and safety certification plus third-party activities. We have developed the Initial Baseline Schedule to meet or exceed contract requirements proposed by the MBTA, with a commitment to the timely completion of the Project Milestones outlined in Volume 1, Section 2.3, while maintaining minimal impacts to the public. Our schedule is aggressive; yet, because it is supported by our experience on similar, relevant rail and DB projects, our schedule is reliable, reasonable, and achievable.

Our schedule strategy is based on our familiarity with and understanding of the Green Line Extension DB Project; our relationship with the MBTA; and knowing how to best allocate the personnel, equipment, and materials necessary to complete the Project within the required timeframe. Our schedule is a direct result of developing an efficient rail construction sequencing approach to maximize work areas and minimize construction impacts to stakeholders, communities, and the traveling public. The Initial Baseline Schedule was developed by:

- ▶ Identifying activities required to support the optimized sequencing plan within each segment
- ▶ Identifying early design packages to support aggressive early construction

- ▶ Using our extensive design experience under the DB umbrella to create a detailed design schedule, including submittals and associated review times, to forecast a more accurate start of construction
- ▶ Applying quantities and proven execution history on production to identify durations associated with the installation

The key elements of the Project Schedule are design work, bridges (both roadway and railroad), drainage, utilities, MOT, subcontracts, rail schedules, geotechnical conditions, retaining and noise walls, and earthwork phasing requirements.

Effective Schedule/Cost Control

With the Baseline Schedule in place, GLX Constructors will use a system of long-range planning and short-term scheduling. The Baseline Schedule will be used for long-range planning and will be organized by a Work Breakdown Structure (WBS), which allows the schedule activities to be separated into schedules for design, pre-construction, and construction. The appropriate managers will develop detailed, short-range schedules for the performance of work within their responsibility areas.

Short-term scheduling will be the basis for the four-week look-ahead schedules. These short-range schedules will be integrated with our subcontractors' work scopes and individual activities. All activity progress will be reported to our Lead Scheduler, who will update the Project Baseline Schedule and analyze the schedule for performance against the Project's milestones.

The Baseline Schedule will be the basis for planning and monitoring the work progress and generating monthly invoices. A cost- and resource-loaded P6 schedule will be fully integrated with GLX Constructors' cost systems.

a. Critical Schedule Management Reporting

Our critical Schedule Management Reporting will include the following reports:

- ▶ Activity Reports with logic ties
- ▶ Bid Item Reports
- ▶ An Example of Craft Performance Curves Reports
- ▶ Look-Back and Look-Ahead Schedules
- ▶ Time-Location Diagrams

We have included example reports from each of these as Appendix 5 – Critical Schedule Management Report Examples.

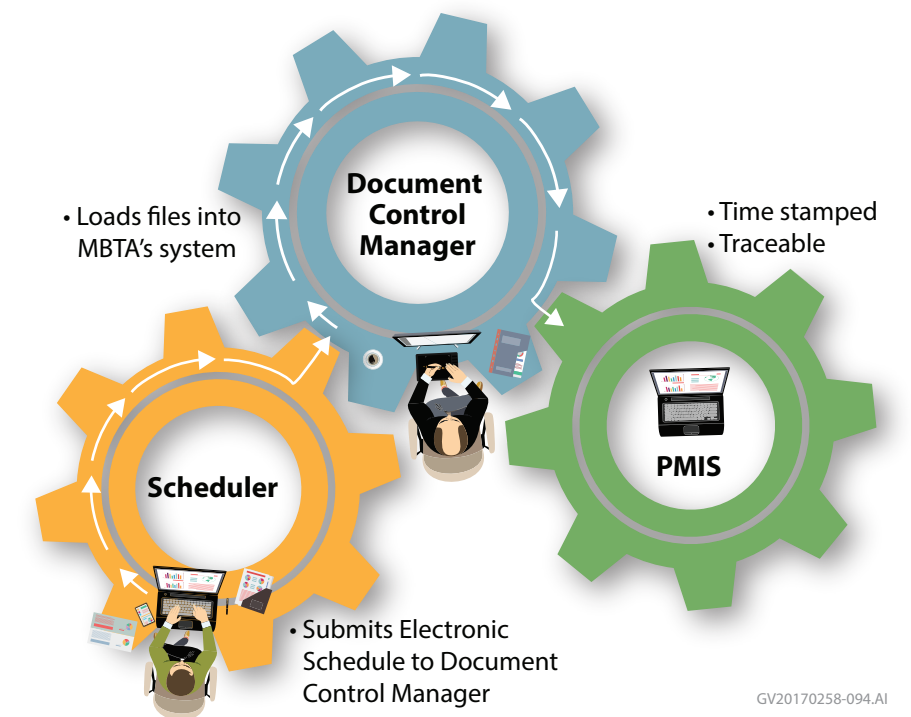

Figure 3.5-6. Document Control System. Our document control process provides accountability and reliability from our Project Controls Team to the MBTA.

b. Integration of Schedule Activities with Document Control

As part of our Document Management Plan, indicated in Figure 3.5-6, we intend to upload all native files into the MBTA's PMIS as required. These native Primavera files can then be uploaded into the MBTA's master schedule.

c. Description of the Schedule Updating Process that will be Implemented and detailed Daily, Weekly, and Monthly

On a daily basis, field engineers will provide information to our Lead Scheduler, who, in turn, will update the schedule based on these daily reports.

On a weekly basis, GLX Constructors will update the cumulative craft-hour performance curves, including self-perform and subcontractor hours within the schedule.

Our Project Controls Team will collect data from the field and analyze the findings. Any schedule impact that identified prior to data collection will be promptly communicated to the Lead Scheduler to be reflected in the schedule. A craft-hour analysis, requirements, and forecast will be updated on a monthly basis.

As required by the Technical Provisions, before the monthly progress meeting with the MBTA, our Project Controls team will submit a draft progress schedule to the MBTA for validation.

In addition to the Monthly Primavera Baseline Scheduling, we will submit a time-location diagram using TILOS, at a minimum of once every two months, as required in Volume 2, Section 2.4.6(h).

GLX Constructors will conduct a weekly meeting that provides a two-week look-back schedule and a four-week look-ahead schedule. Design discipline leads and construction discipline project engineers will lead their superintendents to develop these schedules weekly in conjunction with the Project Controls Leads. The four-week look-ahead schedules will be based on the Project Baseline Schedule, and provide day-to-day details. These details will include activities planned at both the end of the week and at the month-end closing.

Two weeks before our monthly submittal date, GLX Constructors will conduct a meeting with the MBTA to discuss our monthly progress.

d. Description of How GLX Constructors' Project Manager, Design Manager, and Site Supervisors will use the Schedule Information

The Project Manager, Design Manager, and site supervisors will use the Baseline Schedule daily in the field to monitor all scheduled Project activities. The actual work progress will be documented, resource requirements will be evaluated, and critical work areas and tasks will be identified.

Updated critical paths and resource curves will be generated for review with the balance of the Project Team. Analyzing to-date performance compared to

the Baseline Schedule provides the basis for decision making and correcting negative trends as required. The Project Team will analyze actual start and completion dates, cost value of work reported in place, activity physical percent completion, revised logic, remaining durations, craft-hour analysis and forecasting, the influence of change orders (if applicable), and other revisions.

In addition, GLX Constructors and the MBTA will review the look-back and look-ahead schedules; the time-location drawing schedule, or TILOS diagrams; craft-hour performance curves; craft-hour analysis curves showing craft-days of effort for each month; cash flow projection broken out by major cost centers (as determined by the MBTA); identified schedule delays; recovery plans; and detailed schedule narratives.

e. Description of How this Information will be Used in Project Management Meetings

During Project Management Meetings, GLX Constructors and the MBTA will review the progress, forecasted finish for in-progress activities, and re-forecasted early dates for activities planned during the next update period. We will review logic revisions or potential changes in the work, pre-existing activities, revisions due to unauthorized modifications, and recovery schedules. In addition, we will review any schedule delays – with an associated description of their extent and the cause for delay – that occurred since the previous progress schedule submittal. In addition, we will discuss the MBTA's responses to previous update review comments, recap progress, days gained or lost versus the previous progress schedule submittal, changes in resources, and identify delays, their extent, and causes.

From our schedule analysis, a monthly report consisting of the following elements will be developed and discussed at the monthly progress review meetings:

- ▶ **Bar Chart Schedules.** These will include the Level 1 summary schedule (total project and for construction only); near-term Level 3 detailed schedule (two months history and six months into the future); and comparison bar chart schedules with current early and late dates compared to the target date sets – again for the near-term as described herein.
- ▶ **Management Schedule Report.** This is a summary report presenting high-level Project information in a narrative, tabular format. At a minimum, it will include milestone statuses, highlights from the previous update, and any major issues or risks of which the Project Team needs to be aware.
- ▶ **Schedule Progress Narrative Report.** This is a narrative description of the Project's design and construction progress, schedule conformance to the specifications, any deviations from previous progress schedule and/or baseline schedule, and potential schedule issues.



The Project Manager, Design Manager, and site supervisors will use the Baseline Schedule daily in the field to monitor all scheduled Project activities.



We will build all fabricator and subcontractor construction activities into the Project Schedule, and their activities will be appropriately tracked like any other construction activity.

► **Critical and Near-Critical Path Reports.** This report will call attention to the planned activities currently on the critical and near-critical paths, their progress to-date, as well as the variance from the planned schedule.

f. Description of How the Proposer Plans to Capture Work from Fabricators and Subcontractors

Effectively managing our fabricators and subcontractors is critical to maintaining our proposed Schedule. Our subcontractors' work scopes encompass track and guideway, Systems, traction power, rolling stock provisions, and operations and maintenance facilities. During the Proposal Phase, we relied on input from our dedicated subcontractors and fabricators, and we have incorporated the applicable information into our Initial Baseline Schedule.

GLX Constructors will be responsible for managing the progress and successful work completion performed by our fabricators and subcontractors. We will make certain their execution is properly coordinated with our design effort and self-performed construction activities. To properly integrate their activities into the Baseline Schedule, our subcontractors will be co-located and participate in the Project's early Design Phases.

We will build all fabricator and subcontractor construction activities into the Project Schedule, and their activities will be appropriately tracked like any other construction activity. We will hold pre-activity meetings prior to the start of a subcontractor's operation to make certain everyone involved understands the schedule and Project concerns. These meetings will include discussions about safety, environmental, quality, and local neighborhood constraints to make certain that all subcontractors comprehend the expectations and importance of the Project requirements. Subcontractors are to participate in the scheduling, planning on the job, and decisions affecting their work. Ongoing contact and weekly meetings with our fabricators will confirm timely updates to their respective activities are incorporated into our schedule.

The methodology of capturing work from our fabricators and subcontractors will be communicated to the MBTA during the Schedule Planning session with the MBTA within ten days after issuance of NTP.

g. Schedule Coding

GLX Constructors will use a combination of WBS and Activity Codes to organize the schedule and allow for a multifaceted approach to filtering and analyzing the data. We have incorporated the mandatory coding (Stand Cost Category) file as listed in Volume 2, Section 2.4.5(e). We have added additional coding to provide further granularity of activity groups. Our Project Activity Codes are depicted in Appendix 6 – GLX Activity Codes.

h. Work Breakdown Structure/Schedule Organization

The Project's WBS segments were developed as a collaborative effort between the Design Team and the Construction Team.

The WBS is a multi-level, hierarchical arrangement of the work to be performed on the Project. GLX Constructors has laid out the WBS to enable a straightforward identification of areas, segments, responsibilities, and work types within each segment, as shown in Appendix 7 – Work Breakdown Schedule. Our design has been further broken down into specific Design Packages to include clearing and grubbing, drainage, bridges, track, stations, utility bridges, viaducts, retaining walls, systems, roadway bridges, underpasses, community path, roadways, and fencing. Likewise, construction has been divided into smaller work types to include utilities, drainage, bridges, track, stations, systems, drainage, testing, and commissioning, to name a few.

i. Schedule Detail

Following Project Award, we will expand the Initial Baseline Schedule to encompass the full detailed scope of all design and construction activities. It will be used to actively progress the Project and manage our resources. During the Initial Baseline Schedule development, we convened our weekly TWGs to collaborate on the primary disciplinary aspects of the Project, such as utilities, track, drainage, structures, roadway, Systems, testing and commissioning, environmental, maintenance of traffic, and safety. TWGs integrated the participation of all disciplines, including O&M and Light Rail Vehicle (LRV) representatives, to vet issues on specific work elements. The TWGs' primary focus is to meet or exceed the overall Project goals by sharing best practices, determining priorities, identifying concerns, and resolving potential conflicts.

Information gathered during the TWGs formed the basis of our Initial Baseline Schedule and identified the complexities of the scope. The schedule is organized around logical, understandable, buildable units that enable both the MBTA and GLX Constructors to track and monitor design, procurement, and construction activities. This comprehensive schedule identifies critical path design activities to commence with DB Contract Execution and NTP, prioritizes long-lead items, takes advantage of innovations, and illustrates the plan to complete by the defined milestones dates. The schedule has a clear and concise level of detail demonstrating our complete scope understanding. Activity durations are based on consistent calculation methods. The level of detail demonstrating steps, with logic ties, required to complete the work while avoiding lags, is sufficient to control day-to-day activities.

j. Schedule Logic Competency

Our Initial Baseline Schedule represents the complete, logical time-phased representation of the Project plan. It covers the full scope and our understanding of the work execution. There are activity date constraints for the Project's start and finish milestones. The schedule logic is based on a determined sequence of work without resource constraints.

k. Organization and Management of the Critical Path and All of the Other Paths

The schedule's critical path identifies activities with the 0 float path from design, procurement, construction, startup, testing, commissioning, and safety certification. It will clearly identify critical submittals for the MBTA, third parties, and GLX Constructors. Daily monitoring of all schedule activities will alert GLX Constructors of any potential delay in critical path activities. If any critical path work is delayed more than 30 calendar days, we will submit written notice to the MBTA along with a recovery schedule for review and approval.

Managing All Other Paths. As with the critical path activities, we will continuously monitor the near-critical path activities, which have total float values between 1 and 20 days, to make certain that work is performed within the established time allotted. The Project Team's input and active participation is essential. Through daily monitoring, input, feedback, and activities review, we will make certain these near-critical activities do not become critical.

l. Cost Loading Example

Our \$100 million cost loading example includes design, procurement, pre-construction, and construction activities. These activities include labor, equipment, materials, and subcontracts, and they are consistent with bid items. These activities have reasonable and proportional cost allocations to their respective activity and duration. With this cost loading spread, we will extract basic schedule information, categorize it in an Excel spreadsheet, and apply the summarized cost and revenue information of up to 20-30 summary categories each with revenue and cost information. Please see Appendix 8 – \$100 Million Cost Loading Example.

m. Cash Flow Projections

We will perform cash flow projections monthly for the entire life of Project. Projections will include key input from Design Discipline Leads, Material Management, Contract Management, Scheduling, Construction, and Project Business Services. We will measure cash flow projections against early and late baseline revenue curves. These projections will be derived from the schedule data export into tabular format broken out by MBTA-determined major cost centers. Please see Appendix 9 – Cash Flow Projections.

n. Responsibility Coding

The schedule responsibility coding indicates the party responsible for executing a specific activity. We use responsibility coding to break down the work for our designers, subcontractors, suppliers, the MBTA, and other third parties. For the Project's responsibility codes, see Section (g.) above.

o. Design and Construction Submittal management, including, completeness of the list, preparation, review, approval, coding, prioritization, and relation to the start of work

We manage our design and construction submittals to the MBTA and third parties with a database that includes information as it pertains to coding, prioritization, and the relation to the start of the work. Using logical sequences, each submittal to either the MBTA or to third parties shows the subsequent, required review cycles and final submittals. Figures 3.5-7 and 3.5-8 illustrate the completeness of our submittal list, including preparation activities, subsequent reviews and approvals, and appropriate coding.

The prioritization of design activities has been determined by the critical path construction activities. Likewise, design packages have been prioritized accordingly as depicted in Figure 3.5-9. As shown in these three graphics, the Release for Construction (RFC) finish date designates the start of its related construction activity.

Activity ID	Activity Name	Original Duration	Start	Finish	Responsibility
Design		335	19-Apr-17	31-Jul-18	
DSUM	Design - SUMMARY	335	19-Apr-17	31-Jul-18	
Project Wide		335	19-Apr-17	31-Jul-18	
+	Pedestrian Bridge	148	19-Apr-17	10-Nov-17	
+	Pump Stations	148	19-Apr-17	10-Nov-17	
+	Railroad Bridge	148	19-Apr-17	10-Nov-17	
+	Roadway Bridges	160	19-Apr-17	28-Nov-17	
+	Stations	152	19-Apr-17	17-Nov-17	
Ball Square		152	19-Apr-17	17-Nov-17	
DSTASUM	Ball Square Station - Design SUMMARY	152	19-Apr-17	17-Nov-17	
DSTA110	Ball Square Station - Preliminary Design - Submit to MBTA for Review	40	19-Apr-17	14-Jun-17	DBF
DSTA120	Ball Square Station - Preliminary Design - MBTA Review & Comment	20	15-Jun-17	12-Jul-17	MBTA
DSTA130	Ball Square Station - Intermediate Design - Submit to MBTA for Review	20	13-Jul-17	10-Aug-17	DBF
DSTA140	Ball Square Station - Intermediate Design - MBTA Review & Comment	20	11-Aug-17	07-Sep-17	MBTA
DSTA150	Ball Square Station - RFC Design - Submit to MBTA for Review	20	08-Sep-17	05-Oct-17	DBF
DSTA160	Ball Square Station - RFC Design - MBTA Review & Comment	20	06-Oct-17	02-Nov-17	MBTA
DSTA170	Ball Square Station - RFC Design - Incorporate Comments, Release for Construction	5	03-Nov-17	09-Nov-17	DBF
DSTA180	Ball Square Station - Final Design Docs - Submit to MBTA for Review	5	03-Nov-17	10-Nov-17	DBF
DSTA190	Ball Square Station - Final Design Docs - MBTA Review & Approve	5	10-Nov-17	17-Nov-17	MBTA

Figure 3.5-7. Design and Construction Submittal Management to the MBTA.
Demonstrates responsibility coding submissions to the MBTA.



We manage our design and construction submittals to the MBTA and third parties with a database that includes information as it pertains to coding, prioritization, and the relation to the start of the work.

Activity ID	Activity Name	Original Duration	Start	Finish
DCMP100	Community Path - Design SUMMARY	224	13-Dec-17	13-Nov-18
DCMP110	Community Path - Preliminary Design - Submit to MBTA/3rd Party/Govt for Review	20	13-Dec-17	24-Jan-18
DCMP120	Community Path - Preliminary Design - MBTA/3rd Party/Govt Review & Comment	40	25-Jan-18	21-Mar-18
DCMP130	Community Path - Intermediate Design - Submit to MBTA/3rd Party/Govt for Review	10	22-Mar-18	04-Apr-18
DCMP140	Community Path - Intermediate Design - MBTA/3rd Party/Govt Review & Comment	40	05-Apr-18	01-Jun-18
DCMP200	Community Path - Pre-RFC Design - Submit to MBTA/3rd Party/Govt for Review	10	04-Jun-18	15-Jun-18
DCMP210	Community Path - Pre-RFC Design - MBTA/3rd Party/Govt Review & Comment	40	18-Jun-18	13-Aug-18
DCMP150	Community Path - RFC Design - Submit to MBTA/3rd Party/Govt for Review	10	14-Aug-18	27-Aug-18
DCMP160	Community Path - RFC Design - MBTA/3rd Party/Govt Review & Comment	40	27-Aug-18	23-Oct-18
DCMP170	Community Path - RFC Design - Incorporate Comments, Release for Construction	5	23-Oct-18	30-Oct-18
DCMP180	Community Path - Final Design Docs - Submit to MBTA for Review	5	30-Oct-18	06-Nov-18
DCMP190	Community Path - Final Design Docs - MBTA Review & Approve	5	06-Nov-18	13-Nov-18

Figure 3.5-8. Design and Construction Submittal Management to the MBTA and Third Parties. Demonstrates responsibility coding submissions to the MBTA and third parties.

p. Design Schedule Management and Activity Detail

For detail about our Lead Designer's schedule management and activities, such as responsibilities, logic, and resources, see Section (o.) above.

In each of our Design Packages, the specific activities are logically linked and coded to the responsible party. Resources are assigned as shown in our \$100 million cost-loaded schedule sample in order to carefully track cost and schedule adherence.

q. Resource Loading (Labor/Crews and Equipment Detail/Activities)

All scheduled activities will be resource-loaded at a sufficient level to support generating progress curves. The resources will be based on our approved, logic-driven schedule, and quantities from our estimate. We will organize crews according to the resources available, scheduled time of work activities, and work restrictions, such as track access, weather, work hours/day, and the like. This will enable resource leveling that will optimize our resources while meeting or exceeding the schedule requirements.

Additionally, as discussed in Section 3.5.D., the resource-loaded Primavera schedule will be demonstrated in a TILOS time-location diagram that depicts the planned progression of each of the major crews, over-laid with the Project stationing graphic.

r. Production Rate Basis and Relationship to Estimate Details/ Subcontractor Pricing

Our detailed production rate basis is derived from the experience of the four contracting partners' experience working in an active rail corridor. We have linked our crew-based estimate, which also incorporates our subcontractor pricing, to our Primavera P6 schedule. It will be refined upon contract award and will form the basis of the productivities used in our schedule.

Activity ID	Activity Name	Original Duration	Start	Finish
Design				
DESFMS	Design Complete	0		11-Dec-17
Project Wide				
Documentation / Pre-Design Plan				
Earthwork, Clearing & Grubbing				
Community Path				
Track Drainage				
Main Drainage				
Retaining Walls				
Noise Walls				
Fencing				
Viaducts				
Lechmere (LEV)				
Medford (MBV)				
Union Square EB (UEV)				
Union Square WB (UWV)				
Railroad Bridge				
Washington St Bridge				
Roadway Bridges				
Broadway (Bridge No. S-17-013)				
Medford St (Somerville) (Bridge No. S-17-007)				
Cedar St (Somerville) (Bridge No. S-17-012)				
College Ave (Medford) (Bridge No. M-12-012)				
Lowell St (Somerville) (Bridge No. S-17-011)				
School St (Somerville) (Bridge No. S-17-008)				
Walnut St (Somerville) (Bridge No. S-17-006)				
Stations				
Magoun Square				
East Somerville				
Ball Square				
College Ave				
Gilman Square				
Lechmere Relocation				
Union Square				
Track				
Commuter Lines				
Medford, VMF, Union Square, and Yard Lines				
Utility Bridges				
Underpasses				
Walnut St				
Medford St				
School St				
Lowell St Modification				
Systems				
Overhead Contact Systems				
Communications				
Traction Power Systems				
Signaling				
Utilities				
Utility Bridges (Broadway & Medford)				
VMF				
Transportation Office Building				
Vehicle Maintenance Building				
Pump Stations				
Washington St (B)				
Red Bridge				
Washington St (A)				
Pedestrian Bridge				
College Ave				
Roadways & Traffic Improvements				

Figure 3.5-9. Design Package Priorities. We have prioritized our design packages according to critical path construction activities.

s. Considerations for Necessary Steps Needed, Prior to the Start the Physical Work Such as Special Permits and Approvals

GLX Constructors has carefully considered the necessary steps needed prior to breaking ground, including permits, plans, studies, and approvals. Every required permit (obtained by GLX Constructors, the MBTA, and any other third party), approvals, studies, meetings, plans, protocols, SOPs, and statements of qualifications are listed in the Initial Baseline Schedule within the Contract Deliverables/Submittals and Pre-Construction sections.

t. Construction Phasing and Traffic Management Planning

An essential element of all roadway and bridge construction is providing for the safe passage of vehicles, pedestrians, cyclists, and transit operators through the work zone. This includes persons with disabilities in accordance with the Americans with Disabilities Act (ADA) of 1990. Equally as important to the mobility of road users is the safety and protection of the construction workers performing tasks within the work space.

Consistent with MBTA/MassDOT policy, the reconstruction of the Project's roadways and bridges will include a variety of Temporary Traffic Control (TTC) measures depending on the particular work element being performed, the expected duration, and the time of day. When the normal function of the roadway, bridge, sidewalk, bike path, or transit way are suspended for reconstruction, TTC planning provides for the appropriate notification to the public, and for the safety and continuity of movement along roadways while maintaining access to private property and commercial businesses.

GLX Constructors will be responsible for managing the progress and successfully completing Traffic Management Plans. Design activities for traffic management plans will be included in the roadway bridge and railroad bridge design activities to make certain traffic management plans will properly accompany the RFC plans.

Design activities will be included for the submission of traffic management plans for the closures of the Medford Street Bridge, School Street Bridge, Broadway Bridge, and the closure of Washington Street between Joy Street and Tufts Street for the reconstruction of Washington Street and the Railroad Bridge crossing Washington Street to the City of Somerville traffic engineer for prior review and approval. Design activities will be included for the submission of the Traffic Management Plan for the staged construction across the exiting College Avenue Bridge and the intersection of College Avenue and Boston Street.

TTC plans and the variety of devices used for the Project will be consistent with local and industry-wide standards. Public outreach and coordination with the cities of Medford, Somerville, and Cambridge will be important for the approval of the TTC plans and also for coordination of adjacent construction projects, such as the city of Boston's interim work at Sullivan Square by the Wynn casino;

MassDOT's planned rehabilitation to the Maffa Way and Mystic Avenue bridges; and the ongoing work on the Longfellow Bridge, for example.

The FHWA's Manual on Uniform Traffic Control Devices (MUTCD), includes the following guidance:

The MUTCD and MassDOT's Standard Details and Drawings for the Development of TTC Plans will offer the primary guidance on the TTC. Unknown at this time are the means and methods for the work element, road conditions, duration of operations, and physical constraints to the work area. However, the MUTCD and MassDOT standard drawings cover the majority of situations likely to be encountered, such as lane closures, merges, detours, sidewalk and bike lane construction, and will be engineered to fit the specific situation. Special attention will be paid to non-motorized users and persons with disabilities, as all temporary routes must meet ADA guidelines and allow for bicycle travel.

The Project will closely coordinate with transit service providers for the temporary relocation of transit stops and/or bus shelters as needed for construction. A project of this magnitude will also include a robust public outreach component to inform residents and road users of the reconstruction work and planned traffic mitigation including notification via email/text, navigations services (Waze, etc.), and other social media platforms.

GLX Constructors will build MOT activities into the Project Schedule and the activities will be tracked as any other construction activity.

GLX Constructors has carefully considered the necessary construction phasing and traffic management planning to include the appropriate activities for weekly planning and proper execution. Our plan minimizes disruption to the traveling public (rail, pedestrian, vehicular), as shown below.



A project of this magnitude will also include a robust public outreach component to inform residents and road users of the reconstruction work and planned traffic mitigation including notification via email/text, navigations services (Waze, etc.), and other social media platforms.

“

Consideration for road user safety, worker and responder safety, and the efficiency of road user flow is an integral element of every TTC zone, from planning through completion. A concurrent objective of the TTC is the efficient construction and maintenance of the highway and efficient resolution of traffic incidents.

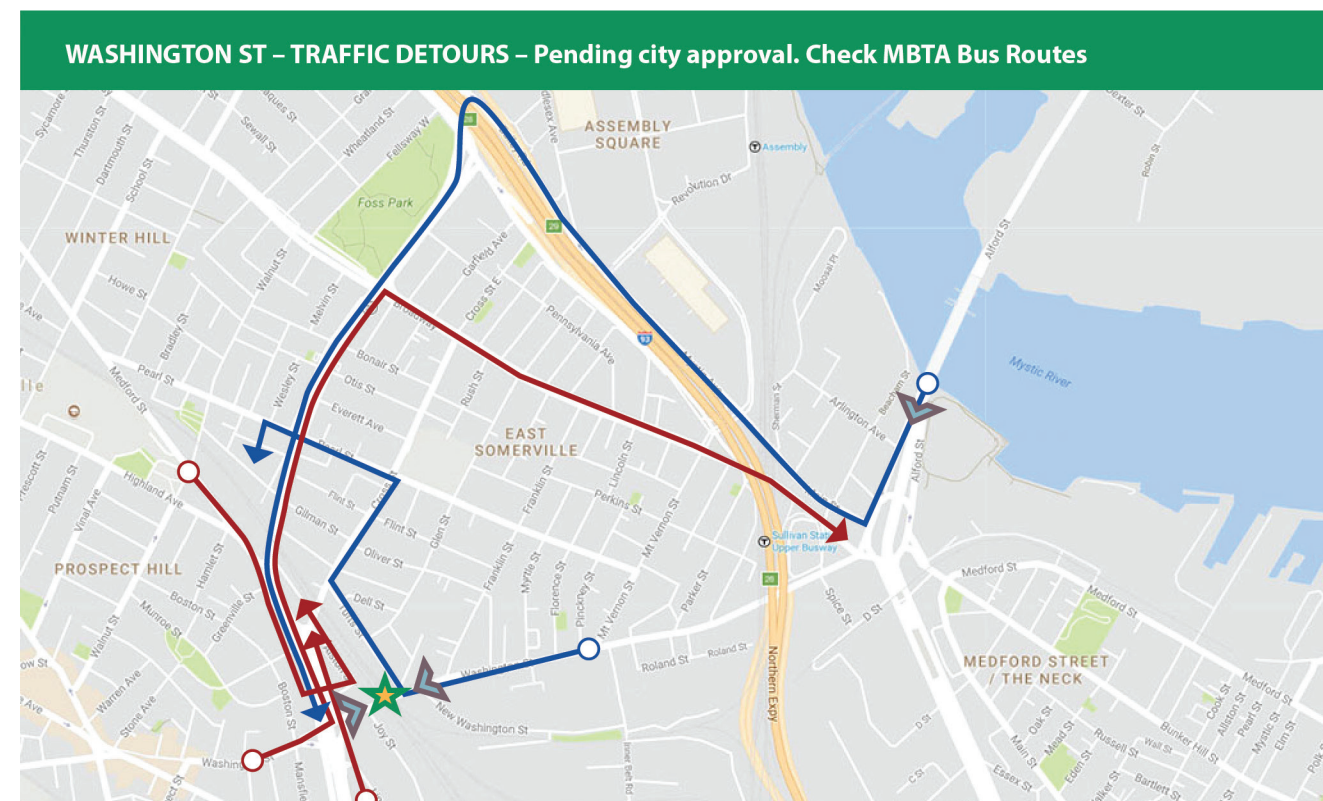

Figure 3.5-10. Washington Street Bridge. The railroad bridge over Washington Street shall be demolished and replaced with a structure which accommodates two proposed System tracks, two existing Railroad tracks, one proposed maintenance track, the Community Path, and new approach slabs. The vertical clearance between Washington Street and the proposed structure shall be increased from 13'-10" to 14'-6" at the minimum. Demolition and removal of the existing bridge and its approach slabs is included in this scope.

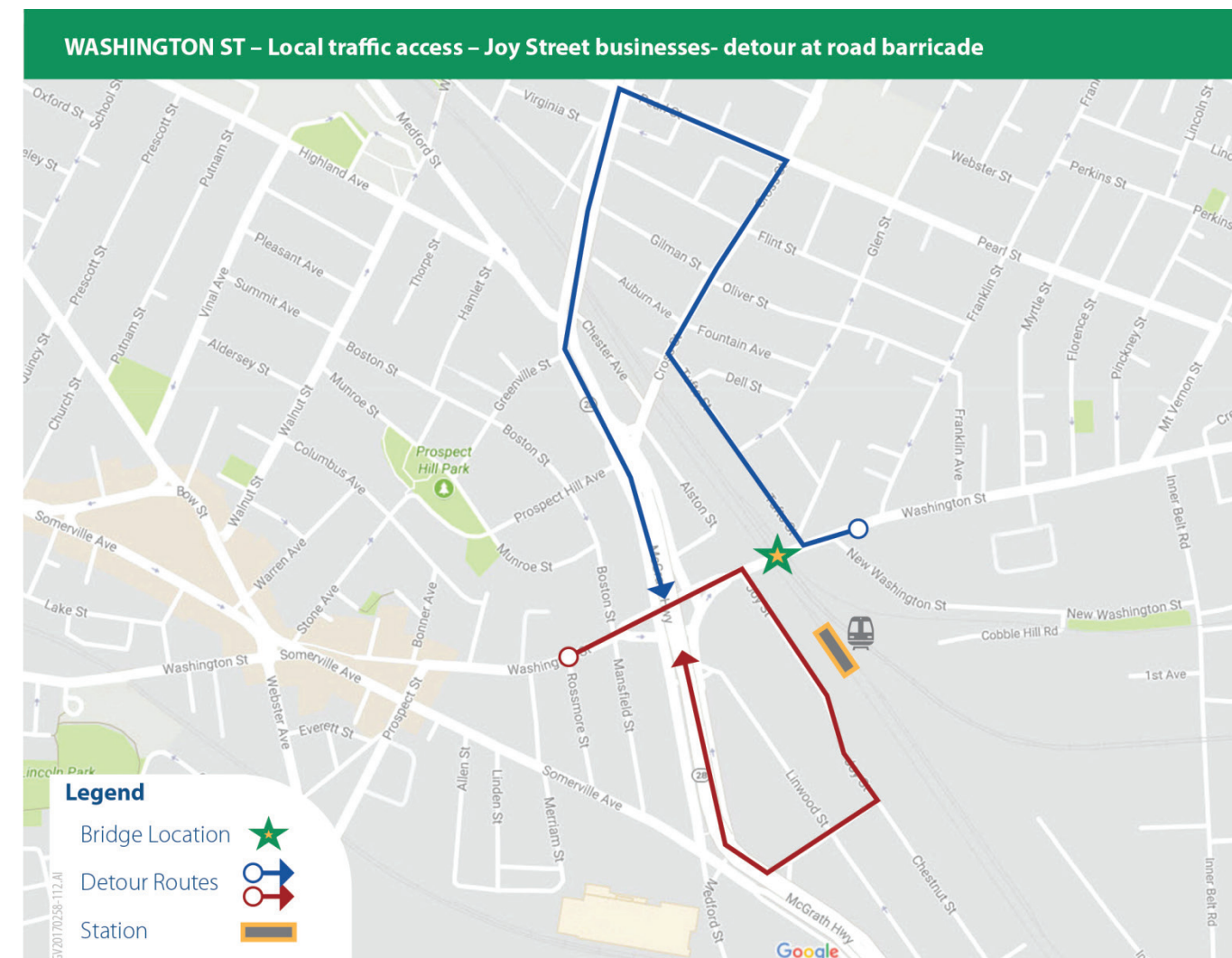

Figure 3.5-11. Washington Street Bridge. The railroad bridge over Washington Street shall be demolished and replaced with a structure which accommodates two proposed System tracks, two existing Railroad tracks, one proposed maintenance track, the Community Path, and new approach slabs. The vertical clearance between Washington Street and the proposed structure shall be increased from 13'-10" to 14'-6" at the minimum. Demolition and removal of the existing bridge and its approach slabs is included in this scope.

u. Payment/Invoicing (relationship to the schedule and bid values)

The cost-loaded schedule determines the monthly activities that must be completed to achieve the Project milestones that maintain the tempo of our schedule. We will base our invoices on the percentage of earned work activities completed within the allotted time frame.

v. Demonstration of the Chosen Scheduling Software Capabilities

GLX Constructors will employ the Primavera P6 Software, an industry standard that is compatible with the MBTA's Primavera Software. The functionality of the Primavera Software includes full import and export capabilities to and from multiple versions of Primavera and with TILOS, our time-location diagram software. Our staff is highly experienced with the functionality of this software.



Figure 3.5-12. Medford Street (Somerville) (Bridge No. S-17-007). An underpass shall be provided at the Medford Street Bridge behind the south abutment. The underpass shall be wide enough to accommodate one System track and associated dynamic clearance envelope (See Section 10), a separation wall with fence, and a minimum 8'-0" clear width for the Community Path.



Figure 3.5-13. School Street (Somerville) (Bridge No. S-17-008). The School Street Bridge shall be supported in place and the south abutment replaced. Behind the new abutment, an underpass structure shall be constructed to accommodate a new System track.

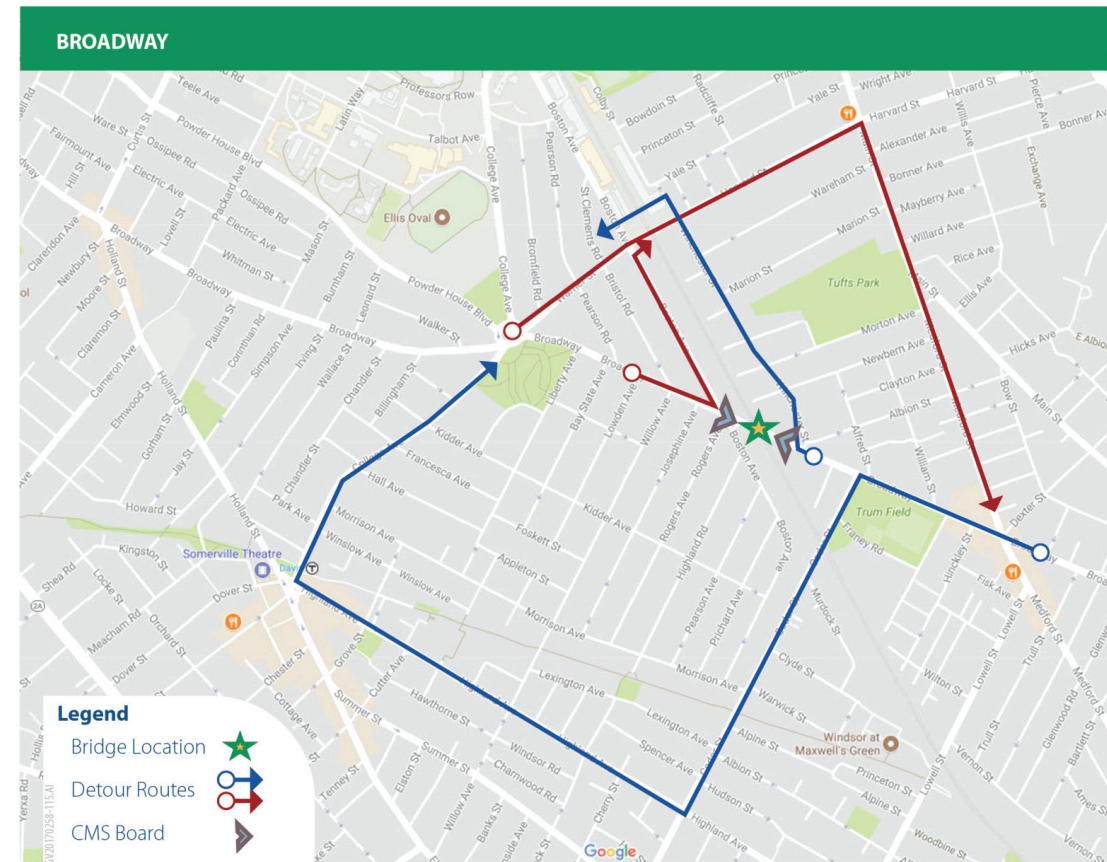

Figure 3.5-14 Broadway Bridge (Bridge No. S-17-013). The existing Broadway Bridge shall be demolished and a new bridge shall be constructed whose clear span is long enough to accommodate the two proposed System tracks and two Railroad tracks in accordance with Section 10.

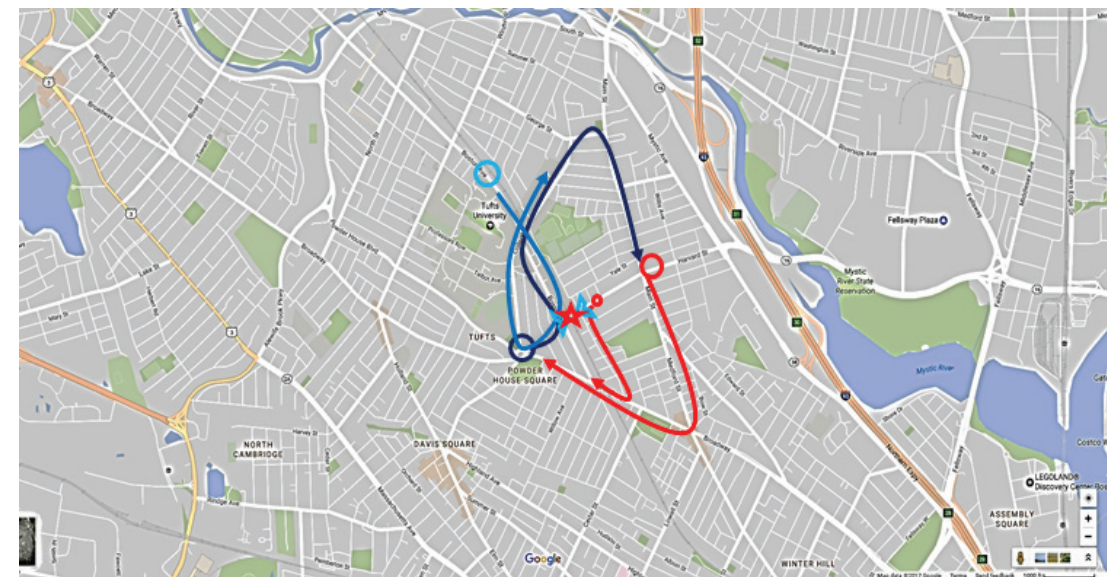

Figure 3.5-15. Harvard Street Rail Bridge. New approach slabs shall be provided to accommodate the existing bridge deck previously complete. The new approach slabs shall run the full width of the new structures and accommodate all drainage and utility requirements as outlined in Section 7.3 and Section 7.4.

COLLEGE AVE – STAGED CONSTRUCTION REQUIRED. LANES ALWAYS OPEN TO TRAFFIC; no detours

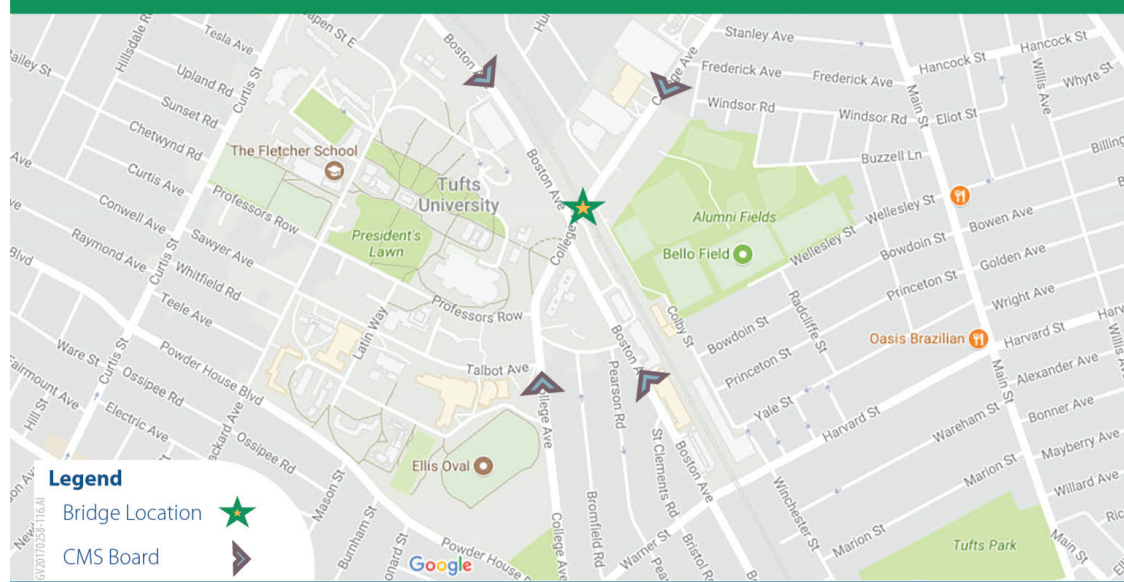

Figure 3.5-16. College Avenue (Medford) (Bridge No. M-12-012). The sidewalk on the north side of the existing bridge shall be removed and this space shall be replaced with 10'-6" right turn lane. The existing College Avenue Bridge shall be modified as necessary to accommodate (from South to North) a 6'-6" sidewalk, 1'-0" shoulder, 12'-2" lane, an 11' lane, a 10'-6" right turn lane, and a 1' shoulder and the two existing bridge rails on both sides. The total width of the existing structure shall be maintained. A separate pedestrian bridge with a minimum clear path width of 12'-0" shall be constructed north of the MWRA utility support structure that is adjacent to the College Avenue Bridge to accommodate both pedestrian and bicycle traffic over the tracks. See Section 8.6 for further information.

w. How Activities will be Rescheduled to Achieve Schedule Recovery Objectives and How Objectives will be Enforced

Rescheduling critical and near-critical activities will be an iterative process with the MBTA and our DB Management Team based on progress reporting from field supervision. The process to reschedule these activities is:

1. Compare to the Baseline Schedule to the previous periodic updated schedule to determine variances .
2. Review variances with our DB Management Team to establish workarounds or a recovery schedule for approval.
3. In Schedule Review Meetings with the MBTA, describe any resource changes and identify delays, their extent, and causes.
4. Itemize and explain changes in activities, calendar, and logic ties, schedule recovery plans, and GLX Constructors-initiated revisions.
5. Incorporate approval from the MBTA.

To recover the schedule, we will add additional equipment and labor resources as needed. Specifically, field managers will be held accountable for the schedule recovery. Please see Section 3.5.F for more information.

x. Innovative Approaches That Have Been Used and Will Be Used For Schedule Controls

For schedule controls, GLX Constructors will utilize TILOS, the industry-leading time-location diagram software, which highlights the number of crews required, concurrent work activities, resource utilization, flagger requirements for safety control, and risk management.

GLX Constructors has created an Initial Baseline Schedule that has been jointly prepared and agreed to by all discipline managers. It expresses realistic expectations of the schedule of work to be completed by all team members and third parties during the course of concurrent Project activities. We are confident that our Schedule, which meets all of the MBTA's milestone requirements, will provide the MBTA and GLX Constructors with the detailed information necessary to effectively manage the Green Line Extension DB Project.

APPENDIX 2

Initial Baseline Schedule Critical Path

Activity ID	Activity Name	Original Duration	Start	Finish	Total Float	2018												2019												2020												2021												2022											
						O	N	D	J	F	M	A	M	J	J	A	S	O	N	D	J	F	M	A	M	J	J	A	S	O	N	D	J	F	M	A	M	J	J	A	S	O	N	D	J	F	M	A	M	J	J	A	S	O	N	D	J								
Green Line Extension Initial Baseline Schedule 20170908						1052	28-Sep-17	08-Oct-21	0																																																								
Milestones						1052	28-Sep-17	08-Oct-21	0																																																								
PWMS011	Financial Proposal Submittal	0		28-Sep-17	0	Financial Proposal Submittal																																																											
PWMS010	Technical Proposal Submittal	0		28-Sep-17	0	Technical Proposal Submittal																																																											
PWMS020	MassDOT Announce Preferred Proponent	0		17-Nov-17*	0	◆ MassDOT Announce Preferred Proponent																																																											
PWMSAWD	Project Award	0		27-Nov-17	0	◆ Project Award																																																											
PWMSNTP	DB Contract Execution and NTP	0		12-Dec-17*	0	◆ DB Contract Execution and NTP																																																											
PWMS006	Plaza Work Complete in Plaza Easement Areas	0		21-Aug-20*	0	◆ Plaza Work Complete in Plaza Easement Areas																																																											
PWMS005	VMF - Functionally Complete & Ready for MBTA Operational Testing	0		30-Sep-20*	0	◆ VMF - Functionally Complete & Ready for MBTA Operational Testing																																																											
PWMS004a	New Green Line (1st Branch) Functionally Complete, Ready for Integrated Testing	0		22-Oct-20*	0	◆ New Green Line (1st Branch) Functionally Complete, Ready for Int																																																											
PWMS004b	New Green Line (1st Branch) Ready for MBTA Demonstration Testing	0		24-Dec-20*	0	◆ New Green Line (1st Branch) Ready for MBTA Demonstration																																																											
PWMS003a	New Green Line (2nd Branch) Functionally Complete, Ready for Integrated Testing	0		30-Dec-20*	0	◆ New Green Line (2nd Branch) Functionally Complete, Ready																																																											
PWMS003b	New Green Line (2nd Branch) Ready for MBTA Demonstration Testing	0		26-Feb-21*	0	◆ New Green Line (2nd Branch) Ready for MBTA Demons																																																											
PWMS004c	New Green Line (1st Branch) Open to Revenue Service	0		20-Apr-21*	0	◆ New Green Line (1st Branch) Open to Revenue Ser																																																											
PWMS003c	New Green Line (2nd Branch) Open to Revenue Service	0		08-Jun-21*	0	◆ New Green Line (2nd Branch) Open to Revenue																																																											
PWMS002	Contract Substantial Completion	0		11-Aug-21*	0	◆ Contract Substantial Completion																																																											
PWMS150	Notice of Final Completion - MBTA Review & Approve	15	20-Sep-21	08-Oct-21	0	■ Notice of Final Completion - MBTA Re																																																											
PWMS001	MBTA Issue Certificate of Final Completion - Contract Final Acceptance	0		08-Oct-21*	0	◆ MBTA Issue Certificate of Final Cdm																																																											
Design						317	12-Dec-17	27-Feb-19	0																																																								
Viaducts						287	12-Dec-17	16-Jan-19	0																																																								
Lechmere (LEV) Pkg 2						287	12-Dec-17	16-Jan-19	0																																																								
DLEV765	Lechmere Viaduct (LEV) Pkg 2 - Preliminary Design - Submit to MBTA for Review	60	12-Dec-17	20-Mar-18	0	■ Lechmere Viaduct (LEV) Pkg 2 - Preliminary Design - Submit to MBTA for Review																																																											
DLEV760	Lechmere Viaduct (LEV) Pkg 2 - Preliminary Design - MBTA Review & Comment	20	21-Mar-18	18-Apr-18	0	■ Lechmere Viaduct (LEV) Pkg 2 - Preliminary Design - MBTA Review & Comment																																																											
DLEV745	Lechmere Viaduct (LEV) Pkg 2 - Pre-RFC Design - Submit to MBTA for Review	60	19-Apr-18	13-Jul-18	0	■ Lechmere Viaduct (LEV) Pkg 2 - Pre-RFC Design - Submit to MBTA for Review																																																											
DLEV740	Lechmere Viaduct (LEV) Pkg 2 - Pre-RFC Design - MBTA Review & Comment	20	16-Jul-18	10-Aug-18	0	■ Lechmere Viaduct (LEV) Pkg 2 - Pre-RFC Design - MBTA Review & Comment																																																											
DLEV755	Lechmere Viaduct (LEV) Pkg 2 - RFC Design - Submit to MBTA for Review	55	13-Aug-18	26-Oct-18	0	■ Lechmere Viaduct (LEV) Pkg 2 - RFC Design - Submit to MBTA for Review																																																											
DLEV750	Lechmere Viaduct (LEV) Pkg 2 - RFC Design - MBTA Review & Comment	20	29-Oct-18	28-Nov-18	0	■ Lechmere Viaduct (LEV) Pkg 2 - RFC Design - MBTA Review & Comment																																																											
DLEV770	Lechmere Viaduct (LEV) Pkg 2 - RFC Design - Incorporate Comments, Release for Construc	35	29-Nov-18	16-Jan-19	0	■ Lechmere Viaduct (LEV) Pkg 2 - RFC Design - Incorporate Comments, Release for Construction																																																											
Retaining & Noise Walls						192	12-Dec-17	05-Sep-18	0																																																								
Retaining Walls (Early)						192	12-Dec-17	05-Sep-18	0																																																								
DRTW240	Retaining Walls (Early) - Preliminary Design - Submit to MBTA for Review	40	12-Dec-17	20-Feb-18	0	■ Retaining Walls (Early) - Preliminary Design - Submit to MBTA for Review																																																											
DRTW250	Retaining Walls (Early) - Preliminary Design - MBTA Review & Comment	20	21-Feb-18	20-Mar-18	0	■ Retaining Walls (Early) - Preliminary Design - MBTA Review & Comment																																																											
DRTW280	Retaining Walls (Early) - Pre-RFC Design - Submit to MBTA for Review	40	22-Mar-18	22-May-18	0	■ Retaining Walls (Early) - Pre-RFC Design - Submit to MBTA for Review																																																											
DRTW290	Retaining Walls (Early) - Pre-RFC Design - MBTA Review & Comment	20	23-May-18	20-Jun-18	0	■ Retaining Walls (Early) - Pre-RFC Design - MBTA Review & Comment																																																											
DRTW320	Retaining Walls (Early) - RFC Design - Submit to MBTA for Review	25	21-Jun-18	25-Jul-18	0	■ Retaining Walls (Early) - RFC Design - Submit to MBTA for Review																																																											
DRTW330	Retaining Walls (Early) - RFC Design - MBTA Review & Comment	20	26-Jul-18	22-Aug-18	0	■ Retaining Walls (Early) - RFC Design - MBTA Review & Comment																																																											
DRTW230	Retaining Walls (Early) - RFC Design - Incorporate Comments, Release for Construction	10	23-Aug-18	05-Sep-18	0	■ Retaining Walls (Early) - RFC Design - Incorporate Comments, Release for Construction																																																											
Track						150	12-Dec-17	09-Jul-18	0																																																								
Medford, Commuter, Union Square						150	12-Dec-17	09-Jul-18	0																																																								
DRWB2490	Medford & Union Line Track - Preliminary Design - Submit to MBTA for Review	65	12-Dec-17	28-Mar-18	0	■ Medford & Union Line Track - Preliminary Design - Submit to MBTA for Review																																																											
DRWB2500	Medford & Union Line Track - Preliminary Design - MBTA Review & Comment	20	29-Mar-18	26-Apr-18	0	■ Medford & Union Line Track - Preliminary Design - MBTA Review & Comment																																																											
DRWB2510	Medford & Union Line Track - Intermediate Design - Submit to MBTA for Review	50	30-Apr-18	09-Jul-18	0	■ Medford & Union Line Track - Intermediate Design - Submit to MBTA for Review																																																											
Drainage						226	12-Dec-17	23-Oct-18	0																																																								
Drainage - Watershed 2						201	12-Dec-17	18-Sep-18	0																																																								
DDRA430	Drainage W2 - Preliminary Design - Submit to MBTA for Review	50	12-Dec-17	06-Mar-18	0	■ Drainage W2 - Preliminary Design - Submit to MBTA for Review																																																											
DDRA425	Drainage W2 - Preliminary Design - MBTA Review & Comment	20	07-Mar-18	03-Apr-18	0	■ Drainage W2 - Preliminary Design - MBTA Review & Comment																																																											
DDRA400	Drainage W2 - Pre-RFC Design - Submit to MBTA for Review	30	04-Apr-18	21-May-18	0	■ Drainage W2 - Pre-RFC Design - Submit to MBTA for Review																																																											
DDRA395	Drainage W2 - Pre-RFC Design - MBTA Review & Comment	20	21-May-18	19-Jun-18	0	■ Drainage W2 - Pre-RFC Design - MBTA Review & Comment																																																											
DDRA420	Drainage W2 - RFC Design - Submit to MBTA for Review	25	19-Jun-18	24-Jul-18	0	■ Drainage W2 - RFC Design - Submit to MBTA for Review																																																											
DDRA415	Drainage W2 - RFC Design - MBTA Review & Comment	20	24-Jul-18	21-Aug-18	0	■ Drainage W2 - RFC Design - MBTA Review & Comment																																																											
DDRA435	Drainage W2 - RFC Design - Incorporate Comments, Release for Construction	20	21-Aug-18	18-Sep-18	0	■ Drainage W2 - RFC Design - Incorporate Comments, Release for Construction																																																											
Drainage - Watershed 3						226	12-Dec-17	23-Oct-18	0																																																								
DDRA480	Drainage W3 - Preliminary Design - Submit to MBTA for Review	60	12-Dec-17	20-Mar-18	0	■ Drainage W3 - Preliminary Design - Submit to MBTA for Review																																																											
DDRA475	Drainage W3 - Preliminary Design - MBTA Review & Comment	20	21-Mar-18	18-Apr-18	0	■ Drainage W3 - Preliminary Design - MBTA Review & Comment																																																											
DDRA450	Drainage W3 - Pre-RFC Design - Submit to MBTA for Review	40	19-Apr-18	15-Jun-18	0	■ Drainage W3 - Pre-RFC Design - Submit to MBTA for Review																																																											
DDRA445	Drainage W3 - Pre-RFC Design - MBTA Review & Comment	20	18-Jun-18	16-Jul-18	0	■ Drainage W3 - Pre-RFC Design - MBTA Review & Comment																																																											

■ Actual Work ■ Critical Remaining Work
■ Remaining Work ◆ Milestone



APPENDIX 3

TILOS Schedule for Union Square Line

Segment 6 - Union Square

0+00

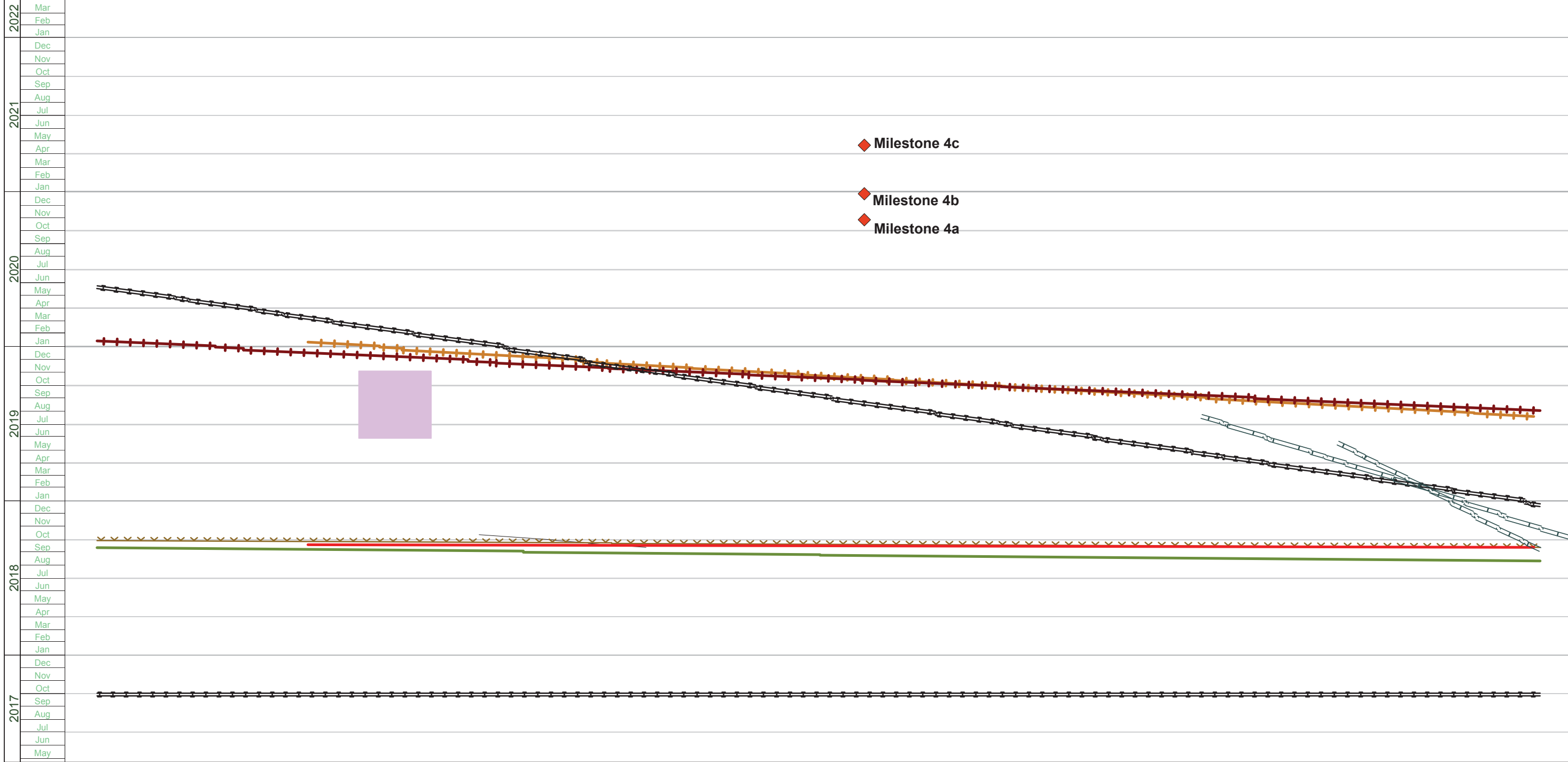

Project: GLX Constructors
Printed: 08.30.2017

Clearing & Grubbing		Viaducts		Systems	
Earthwork		Union Square Station		GLXFMS	
Main Drainage		Track - Un Sq EB			
Retaining Wall		Track - Un Sq WB			



APPENDIX 4

TILOS Schedule for Medford Line

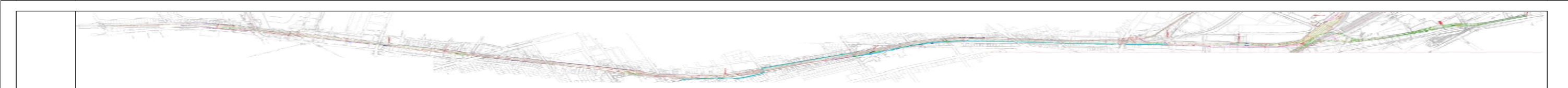

Segment 1	Segment 2	Segment 3	Segment 4
344+00	295+00	221+80	177+90

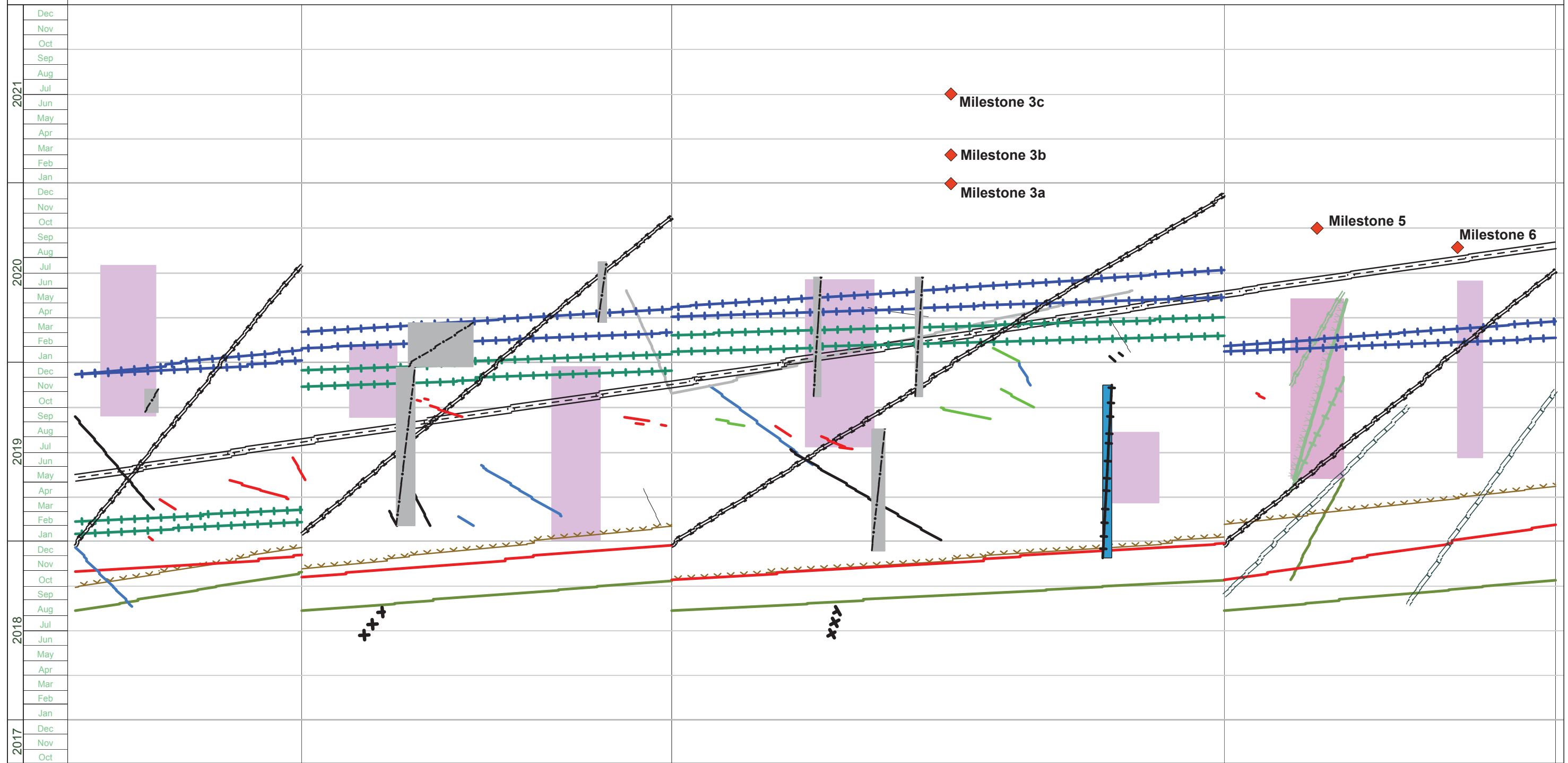

CG		SPLW		STR		RRBR		SYS		VMFTRK		VMFBL	
EW		SPLW		STA		RWBR		PS		VMFCG		GLXFMS	
MD		MPB		VIAD		TRKCL		RWTI		VMFSYS			
RW		CWR		CMP		TRKML		VMFBL		VMFFMS			

Project: GLX Constructors
Printed: 08.30.2017



APPENDIX 5

Critical Schedule Management Report Examples

GLX Activities with Pred/Succ

Activity ID	Activity Name	Predecessors	Successors	
A6020	Track - Design SUMMARY			
A6030	Track S2 - SUMMARY			
A6050	Track S3 - SUMMARY			
A6070	Systems S3 - SUMMARY			
A6080	Track S4 - SUMMARY			
A6090	Systems S4 - SUMMARY			
A6110	Systems S5 (VMF) - SUMMARY			
A6120	Track S6 (Union Square Branch) - SUMMARY			
A6130	Ball Sq TPSS - Install, Field Test	C2TPS170, C2STA2105, PRTPS100, DUDP950	TMB3A145	
<u>Activity ID</u>	<u>Activity Name</u>	<u>Relationship Type</u>	<u>Lag</u>	<u>Driving</u>
C2TPS170	Ball Sq TPSS - Field Test	FF	0	No
C2STA2105	Ball Square Station - Excavate, CIP Frost Wall & Backfill	SS	0	Yes
PRTPS100	Traction Power Substation - Fabricate & Deliver	SS	40	No
DUDP950	Traction Power Systems - RFC Design - Incorporate Comments, Release for Construction	FS	0	No
<u>Activity ID</u>	<u>Activity Name</u>	<u>Relationship Type</u>	<u>Lag</u>	<u>Driving</u>
TMB3A145	(3a) - LFAT and Systems Integration Testing	FF	0	No
A6140	Segment 1 - SUMMARY			
A6150	Segment 2 - SUMMARY			
A6160	Segment 3 - SUMMARY			
A6170	Segment 4 - SUMMARY			



GLX Activities with Pred/Succ

Activity ID	Activity Name	Predecessors	Successors
A6180	Segment 5 VMF - SUMMARY		
A6190	Segment 6 - Union Square - SUMMARY		
A6200	Final Testing - SUMMARY		
A6210	Roadway & Traffic Improvements - SUMMARY		

C1CGE105	Clearing & Grubbing - Segment 1	PSTU105, DDRA340	C1UT135, C1UT130, C1UT125, C1UT115, C1UT110, C1UT105, C1DRA135, C1CGE110
-----------------	--	-------------------------	---

<u>Activity ID</u>	<u>Activity Name</u>	<u>Relationship Type</u>	<u>Lag</u>	<u>Driving</u>
PSTU105	Pre-Construction Studies - Design Confirmation	FS	0	No
DDRA340	Earthwork, Clearing & Grubbing - RFC Design - Incorporate Comments, Release for Construction	FS	0	Yes

<u>Activity ID</u>	<u>Activity Name</u>	<u>Relationship Type</u>	<u>Lag</u>	<u>Driving</u>
C1UT135	Utilities - Relocate Overhead ELEC STA 357+25 MB-WB to STA 375+00 MB-WB (MBTA)	FS	0	No
C1UT130	Utilities - Relocate FIBER OPTICS Overhead STA 357+25 MB-WB to STA 375+00 MB-WB (MBTA)	FS	0	No
C1UT125	Utilities - Relocate 4" FIBER OPTIC Overhead STA 335+00 MB-WB to STA 357+00 MB-WB	FS	0	No
C1UT115	Utilities - Relocate Overhead ELEC on College Ave Bridge STA	FS	0	No



GLX Activities with Pred/Succ

Activity ID	Activity Name	Predecessors	Successors
	363+50 MB-WB		
C1UT110	Utilities - 30" MDC C/W Water ABANDONED Demolish & Cap STA 358+50 MB-WB	0	No
C1UT105	Utilities - 24" MDC C/W Water ABANDONED Demolish & Cap STA 358+50 MB-WB	0	No
C1DRA135	Main Drainage - Excavate & Install	0	Yes
C1CGE110	Earthwork - Segment 1	30	Yes

C1CGE110	Earthwork - Segment 1	DDRA340, C1CGE105	C1SG200, C1DRA135, C1RWB110, C1OCS110, C1OCS105, C1RNW170, C1RNW165, C1RNW105, C1RNW115, C1RNW110, C1RNW125
-----------------	------------------------------	--------------------------	--

<u>Activity ID</u>	<u>Activity Name</u>	<u>Relationship Type</u>	<u>Lag</u>	<u>Driving</u>
DDRA340	Earthwork, Clearing & Grubbing - RFC Design - Incorporate Comments, Release for Construction	FS	0	No
C1CGE105	Clearing & Grubbing - Segment 1	SS	30	Yes
<u>C1SG200</u>	<u>Segment 1 Complete</u>	<u>FS</u>	<u>0</u>	<u>No</u>
C1DRA135	Main Drainage - Excavate & Install	SS	0	No
C1RWB110	College Ave Bridge (M-12-012) - Demo Existing Sidewalk (on north side) and Railing	FS	0	No



GLX Activities with Pred/Succ

Activity ID	Activity Name	Predecessors	Successors
C1OCS110	Medford Line EB - Drill & Place OCS Foundations & Poles	FF	10 No
C1OCS105	Medford Line WB - Drill & Place OCS Foundations & Poles	FF	10 No
C1RNW170	Retaining Wall MW-9.5 (360+75 - 362+80) - Install Modular Pre-Cast Block Wall	FS	0 No
C1RNW165	Retaining Wall ME-2.5 (363+75 - 364+25) - Install Modular Pre-Cast Block Wall	FS	0 No
C1RNW105	Retaining Wall MW-10 (363+63 - 374+02) - Install Soil Nail Wall	FS	0 No
C1RNW115	Retaining Wall MW-8.2 (343+56 - 345+20) - Install MSE Wall	FS	1 No
C1RNW110	Retaining Wall ME-3 (366+50 - 374+00) - Install Soldier Pile Wall	FF	0 Yes
C1RNW125	Retaining Wall MW-9 (345+80 - 353+54) - Install MSE Wall	FS	1 No

C1COM105 College Ave Station - Mechanical, Electrical, Communications Eq C1STA1135, PRCME100, DUDP850 C1COM115

<u>Activity ID</u>	<u>Activity Name</u>	<u>Relationship Type</u>	<u>Lag</u>	<u>Driving</u>
C1STA1135	College Ave Station - Shelter, Roof	FF	10	Yes
PRCME100	Communications Equipment - Fabricate & Deliver	FS	0	No
DUDP850	Communications - RFC Design - Incorporate Comments, Release for Construction	FS	0	No
<u>Activity ID</u>	<u>Activity Name</u>	<u>Relationship Type</u>	<u>Lag</u>	<u>Driving</u>
C1COM115	College Ave Station - Pull & Terminate Wire,	FS	0	No



GLX Activities with Pred/Succ

Activity ID	Activity Name	Predecessors	Successors
Local Test			
C1COM110	College Ave Station - Install FDP & Patch Cables	C1STA1135, DUDP850	C1COM115
<u>Activity ID</u>	<u>Activity Name</u>	<u>Relationship Type</u>	<u>Lag</u> <u>Driving</u>
C1STA1135	College Ave Station - Shelter, Roof	FF	10 Yes
DUDP850	Communications - FS RFC Design - Incorporate Comments, Release for Construction		0 No
<u>Activity ID</u>	<u>Activity Name</u>	<u>Relationship Type</u>	<u>Lag</u> <u>Driving</u>
C1COM115	College Ave Station - Pull & Terminate Wire, Local Test	FS	0 No
C1COM115	College Ave Station - Pull & Terminate Wire, Local Test	C1COM110, C1STA1150, C1COM105	TMB3A145
<u>Activity ID</u>	<u>Activity Name</u>	<u>Relationship Type</u>	<u>Lag</u> <u>Driving</u>
C1COM110	College Ave Station - Install FDP & Patch Cables	FS	0 No
C1STA1150	College Ave Station - Lighting, Signage, Finishes	FF	0 Yes
C1COM105	College Ave Station - Mechanical, Electrical, Communications Eqp	FS	0 No
<u>Activity ID</u>	<u>Activity Name</u>	<u>Relationship Type</u>	<u>Lag</u> <u>Driving</u>
TMB3A145	(3a) - LFAT and Systems Integration Testing	FF	0 No
C1CTRK100	Commuter Track 1 EB - SUMMARY		
C1CTRK115	Commuter Track 1 EB - Install Ties & Rail	C1CTRK150, PRTRK100	C1CTRK120
<u>Activity ID</u>	<u>Activity Name</u>	<u>Relationship Type</u>	<u>Lag</u> <u>Driving</u>
C1CTRK150	Commuter Track 1 EB - Install Bottom Ballast	SS	2 Yes



GLX Activities with Pred/Succ

Activity ID	Activity Name	Predecessors	Lag	Driving	Successors
PRTRK100	Trackwork - Fabricate & ...	FS	0	No	
<u>Activity ID</u>	<u>Activity Name</u>	<u>Relationship Type</u>	<u>Lag</u>	<u>Driving</u>	
C1CTRK120	Commuter Track 1 EB - Install Top Ballast, Surface & Line	SS	2	Yes	
C1CTRK120	Commuter Track 1 EB - Install Top Ballast, Surface & Line	C1CTRK115			C1CTRK125
<u>Activity ID</u>	<u>Activity Name</u>	<u>Relationship Type</u>	<u>Lag</u>	<u>Driving</u>	
C1CTRK115	Commuter Track 1 EB - Install Ties & Rail	SS	2	Yes	
<u>Activity ID</u>	<u>Activity Name</u>	<u>Relationship Type</u>	<u>Lag</u>	<u>Driving</u>	
C1CTRK125	Commuter Track 1 EB - Destress & Weld Track	SS	2	Yes	
C1CTRK125	Commuter Track 1 EB - Destress & Weld Track	C1CTRK120			C1CTRK155, C1SG200
<u>Activity ID</u>	<u>Activity Name</u>	<u>Relationship Type</u>	<u>Lag</u>	<u>Driving</u>	
C1CTRK120	Commuter Track 1 EB - Install Top Ballast, Surface & Line	SS	2	Yes	
<u>Activity ID</u>	<u>Activity Name</u>	<u>Relationship Type</u>	<u>Lag</u>	<u>Driving</u>	
C1CTRK155	Commuter Track 2 WB - Install Bottom Ballast	FS	0	Yes	
C1SG200	Segment 1 Complete	FS	0	No	
C1CTRK135	Commuter Track 2 WB - Install Ties & Rail	C1CTRK155, PRTRK100			C1CTRK140
<u>Activity ID</u>	<u>Activity Name</u>	<u>Relationship Type</u>	<u>Lag</u>	<u>Driving</u>	
C1CTRK155	Commuter Track 2 WB - Install Bottom Ballast	SS	2	Yes	
PRTRK100	Trackwork - Fabricate & ...	FS	0	No	
<u>Activity ID</u>	<u>Activity Name</u>	<u>Relationship Type</u>	<u>Lag</u>	<u>Driving</u>	
C1CTRK140	Commuter Track 2 WB - Install Top Ballast, Surface & Line	SS	2	Yes	
C1CTRK140	Commuter Track 2 WB - Install Top Ballast, Surface & Line	C1CTRK135			C1CTRK145
<u>Activity ID</u>	<u>Activity Name</u>	<u>Relationship Type</u>	<u>Lag</u>	<u>Driving</u>	



GLX Activities with Pred/Succ

Activity ID	Activity Name	Predecessors	Successors
C1CTRK135	Commuter Track 2 WB - Install Ties & Rail	SS	2 Yes
<u>Activity ID</u>	<u>Activity Name</u>	<u>Relationship Type</u>	<u>Lag</u> <u>Driving</u>
C1CTRK145	Commuter Track 2 WB - Destress & Weld Track	SS	2 Yes
C1CTRK145	Commuter Track 2 WB - Destress & Weld Track	C1CTRK140	C1RNW170, C1RNW105, C1MTRK160, C1DRA150, C1SG200
<u>Activity ID</u>	<u>Activity Name</u>	<u>Relationship Type</u>	<u>Lag</u> <u>Driving</u>
C1CTRK140	Commuter Track 2 WB - Install Top Ballast, Surface & Line	SS	2 Yes
<u>Activity ID</u>	<u>Activity Name</u>	<u>Relationship Type</u>	<u>Lag</u> <u>Driving</u>
C1RNW170	Retaining Wall MW-9.5 (360+75 - 362+80) - Install Modular Pre-Cast Block Wall	FS	0 Yes
C1RNW105	Retaining Wall MW-10 (363+63 - 374+02) - Install Soil Nail Wall	FS	0 Yes
C1MTRK160	Medford Line EB - Install Sub Ballast	FS	0 No
C1DRA150	Commuter Line 2 WB Track Drainage - Excavate & Install Drainage	FS	0 No
C1SG200	Segment 1 Complete	FS	0 No
C1CTRK150	Commuter Track 1 EB - Install Bottom Ballast	C1DRA110, C1RNW165, C1DRA135, DRWB2460, C1RNW110	C1CTRK115
<u>Activity ID</u>	<u>Activity Name</u>	<u>Relationship Type</u>	<u>Lag</u> <u>Driving</u>
C1DRA110	Commuter Line 1 EB Track Drainage - Excavate & Install	FS	0 Yes
C1RNW165	Retaining Wall ME-2.5 (363+75 - 364+25) - Install Modular Pre-Cast Block Wall	FS	0 No



GLX Activities with Pred/Succ

Activity ID	Activity Name	Predecessors	Successors
C1DRA135	Main Drainage - Excavate & Install	FS	0 No
DRWB2460	Commuter Line Track - RFC Design - Incorporate Comments, Release for Construction	FS	0 No
C1RNW110	Retaining Wall ME-3 (366+50 - 374+00) - Install Soldier Pile Wall	FS	0 No
<u>Activity ID</u>	<u>Activity Name</u>	<u>Relationship Type</u>	<u>Lag</u> <u>Driving</u>
C1CTRK115	Commuter Track 1 EB - Install Ties & Rail	SS	2 Yes

C1CTRK155 Commuter Track 2 WB - Install Bottom Ballast C1CTRK125, DRWB2460 C1CTRK135

Activity ID	Activity Name	Relationship Type	Lag	Driving
C1CTRK125	Commuter Track 1 EB - Destress & Weld Track	FS	0	Yes
DRWB2460	Commuter Line Track - RFC Design - Incorporate Comments, Release for Construction	FS	0	No
<u>Activity ID</u>	<u>Activity Name</u>	<u>Relationship Type</u>	<u>Lag</u>	<u>Driving</u>
C1CTRK135	Commuter Track 2 WB - Install Ties & Rail	SS	2	Yes

C1CTRK165 Commuter Track 2 WB - SUMMARY

C1DRA100 Drainage S1 - SUMMARY

C1DRA110 Commuter Line 1 EB Track Drainage - Excavate & Install C1RNW165, C1RNW110, C1DRA135, DDRA170 C1CTRK150

Activity ID	Activity Name	Relationship Type	Lag	Driving
C1RNW165	Retaining Wall ME-2.5 (363+75 - 364+25) - Install Modular Pre-Cast Block Wall	FS	0	Yes
C1RNW110	Retaining Wall ME-3 (366+50 -	FS	0	No



GLX Activities with Pred/Succ

Activity ID	Activity Name	Predecessors	Successors
C1DRA135	Soldier Pile Wall Main Drainage - Excavate & Install	FS	0 No
DDRA170	Track Drainage - RFC Design - Incorporate Comments, Release for Construction	FS	0 No
<u>Activity ID</u>	<u>Activity Name</u>	<u>Relationship Type</u>	<u>Lag</u> <u>Driving</u>
C1CTRK150	Commuter Track 1 EB - Install Bottom Ballast	FS	0 Yes

Activity ID	Activity Name	Relationship Type	Lag	Driving
C1DRA125	Medford Line WB Track Drainage - Excavate & Install			
			C1MTRK155, C1RNW115, C1RNW125, C1RNW105, DDRA170	C1SG200
C1MTRK155	Medford Line WB - Destress & Weld Track	FS	0	Yes
C1RNW115	Retaining Wall MW-8.2 (343+56 - 345+20) - Install MSE Wall	FS	0	No
C1RNW125	Retaining Wall MW-9 (345+80 - 353+54) - Install MSE Wall	FS	0	No
C1RNW105	Retaining Wall MW-10 (363+63 - 374+02) - Install Soil Nail Wall	FS	0	No
DDRA170	Track Drainage - RFC Design - Incorporate Comments, Release for Construction	FS	0	No
<u>Activity ID</u>	<u>Activity Name</u>	<u>Relationship Type</u>	<u>Lag</u>	<u>Driving</u>
C1SG200	Segment 1 Complete	FS	0	No

Activity ID	Activity Name	Relationship Type	Lag	Driving
C1DRA135	Main Drainage - Excavate & Install			
			C1CGE110, C1CGE105, DDRA230	C1SG200, C1DRA110, C1CTRK150
C1CGE110	Earthwork - Segment 1	SS	0	No
C1CGE105	Clearing & Grubbing -	FS	0	Yes



GLX Activities with Pred/Succ

Activity ID	Activity Name	Predecessors	Successors
	Segment 1		
DDRA230	Main Drainage - RFC Design - Incorporate Comments, Release for Construction	FS	0 No
<u>Activity ID</u>	<u>Activity Name</u>	<u>Relationship Type</u>	<u>Lag</u> <u>Driving</u>
C1SG200	Segment 1 Complete	FS	0 No
C1DRA110	Commuter Line 1 EB Track Drainage - Excavate & Install	FS	0 No
C1CTRK150	Commuter Track 1 EB - Install Bottom Ballast	FS	0 No

C1DRA150 Commuter Line 2 WB Track Drainage - Excavate & Install Drainage C1CTRK145, C3DRA110 C1SG200

Activity ID	Activity Name	Relationship Type	Lag	Driving
C1CTRK145	Commuter Track 2 WB - Destress & Weld Track	FS	0	No
C3DRA110	Commuter Line 1 EB Track Drainage - Excavate & Install	FS	0	Yes
<u>Activity ID</u>	<u>Activity Name</u>	<u>Relationship Type</u>	<u>Lag</u>	<u>Driving</u>
C1SG200	Segment 1 Complete	FS	0	No

C1MTRK120 Medford Line EB - Install Ties & Rail C1MTRK190, PRTRK100 C1MTRK145, C1MTRK125

Activity ID	Activity Name	Relationship Type	Lag	Driving
C1MTRK190	Medford Line EB - Install Bottom Ballast	SS	2	Yes
PRTRK100	Trackwork - Fabricate & Install	FS	0	No
<u>Activity ID</u>	<u>Activity Name</u>	<u>Relationship Type</u>	<u>Lag</u>	<u>Driving</u>
C1MTRK145	Medford Line WB - Install Ties & Rail	FS	0	Yes
C1MTRK125	Medford Line EB - Install Top Ballast, Surface & Line	SS	2	Yes

C1MTRK125 Medford Line EB - Install Top Ballast, Surface & Line C1MTRK120 C1OCS115, C1MTRK130

Activity ID	Activity Name	Relationship Type	Lag	Driving
-------------	---------------	-------------------	-----	---------



Example - Bid Item Report

Bid	Client No.	Type	Description	Bid Quan	Takeoff Quan	Unit	Total Labor	Total Labor UC	Burden	Burden UC	PM	CM	Sub	Equipment	Unit Cost	Total	D-Group
1		D	DIRECT COST ITEMS	1.000	1.000	LS											P
10000		D	### MOBILIZATION ###	1.000	1.000	LS											0
20001		D	AREA 1### REMOVALS & DEMOLITION ###	1.000	1.000	LS											1
20002		D	AREA 2### REMOVALS & DEMOLITION ###	1.000	1.000	LS											2
20003		D	AREA 3### REMOVALS & DEMOLITION ###	1.000	1.000	LS											3
20101		D	REMOVAL OF EXSTG. OBSTRUCTIONS (REMOVE FENCE)	4,628.000	4,628.000	LF											1
20201		D	REM.&DISP. EXSTG. WALLS	96.000	96.000	CY											1
20301		D	REM. & DISP.OF EXIST. CONC.PAVEMENT	6,794.000	6,794.000	SY											1
20303		D	REM. & DISP.OF EXIST. CONC.PAVEMENT	1,807.000	1,807.000	SY											3
20403		D	REM. & DISP. OF EXISTING CURB	6,991.000	6,991.000	LF											3
20501		D	REM.&DISP.OF EXIST ASPH. PVMT.	1,850.000	1,850.000	SY											1
20503		D	REM.&DISP.OF EXIST ASPH. PVMT.	21,270.000	21,270.000	SY											3
20601		D	REM. & DISP. OF EXIST.SHOULDERS	22,828.000	22,828.000	SY											1
20703		D	REM. & DISP.OF EXISTING CONC.SDWLK	3,153.000	3,153.000	CY											3
20801		D	REM. & DISP.OF CONC.MED.BARR.	400.000	400.000	LF											1
20901		D	REMOVAL OF EXIST. GUARDRAIL	11,304.000	11,304.000	LF											1
21001		D	DEMO EXIST. BRIDGE&RAMPS-CMPLTE	96,224.000	96,224.000	SF											1
21103		D	REMOVAL OF PAVEMENT MARKINGS	12,240.000	12,240.000	LF											3
21201		D	DEMO EXIST. BUILDINGS-CMPLTE	210,322.000	210,322.000	SF											1
30001		D	AREA 1###CLEAR, ERTHWK,GRADING&GRND IMPRVMENTS ###	1.000	1.000	LS											1
30002		D	AREA 2###CLEAR, ERTHWK,GRADING&GRND IMPRVMENTS ###	1.000	1.000	LS											2
30003		D	AREA 3###CLEAR, ERTHWK,GRADING&GRND IMPRVMENTS ###	1.000	1.000	LS											3
30101		D	CLEAR. & GRUB. WITHIN ROW	29.000	29.000	ACRE											1
30102		D	CLEAR. & GRUB. WITHIN ROW	10.000	10.000	ACRE											2
30103		D	CLEAR. & GRUB. WITHIN ROW	8.000	8.000	ACRE											3
30201		D	UNCLASSIFIED EXCAVATION	61,467.000	61,467.000	CY											1
30202		D	UNCLASSIFIED EXCAVATION	1,315.000	1,315.000	CY											2
30203		D	UNCLASSIFIED EXCAVATION	17,817.000	17,817.000	CY											3
30252		D	OVEREXCAVATION	19,320.000	19,320.000	CY											2
30253		D	OVEREXCAVATION	9,680.000	9,680.000	CY											3
30301		D	FINE GRADE	252,540.000	252,540.000	SY											1
30302		D	FINE GRADE	20,700.000	20,700.000	SY											2
30303		D	FINE GRADE	140,760.000	140,760.000	SY											3
30401		D	F&I SETTLEMENT DEVICES&MONITORING	9.000	9.000	EA											1
30501		D	GRASS LINED SWALES	13,464.000	13,464.000	LF											1
30503		D	GRASS LINED SWALES	1,000.000	1,000.000	LF											3
30601		D	RETENTION / DETENTION PONDS	2,900.000	2,900.000	CY											1
30701		D	EARTHQUAKE DRAINS	254,741.000	254,741.000	LF											1
30702		D	EARTHQUAKE DRAINS	26,462.000	26,462.000	LF											2
30703		D	EARTHQUAKE DRAINS	49,629.000	49,629.000	LF											3
30803		D	TIMBER PILE STABILIZATION	37,602.000	37,602.000	LF											3
30901		D	STONE COLUMN STABILIZATION	480.000	480.000	EA											1
30903		D	STONE COLUMN STABILIZATION	752.000	752.000	EA											3
31001		D	GEOTEXTILE / GEOGRID REINF.	4,680.000	4,680.000	SY											1
31003		D	GEOTEXTILE / GEOGRID REINF.	29,683.000	29,683.000	SY											3
31101		D	EMBANKMENT IN PLACE-INCL SURCHARGE	145,093.000	145,093.000	CY											1
31102		D	EMBANKMENT IN PLACE-INCL SURCHARGE	8,963.000	8,963.000	CY											2
31103		D	EMBANKMENT IN PLACE-INCL SURCHARGE	32,630.000	32,630.000	CY											3
31111		D	EMBANKMENT	155,245.000	155,245.000	CY											1
31112		D	EMBANKMENT	10,031.000	10,031.000	CY											2
31113		D	EMBANKMENT	33,756.000	33,756.000	CY											3
31131		D	BACKFILL CURBS, SIDWLK,SHLDRS,MUP	2,449.000	2,449.000	CY											1
31133		D	BACKFILL CURBS, SIDWLK,SHLDRS,MUP	1,565.000	1,565.000	CY											3
31143		D	F & I 18" TOPSOIL & PLANTED MEDIAN	1,199.000	1,199.000	CY											3
31201		D	PLACE&REMOVE SURCHARGE MATERIAL-RAMP A	2,278.000	2,278.000	CY											1
31301		D	PLACE&REMOVE SURCHARGE MATERIAL-RAMP B	1,194.000	1,194.000	CY											1
31501		D	PLACE&REMOVE SURCHARGE MATERIAL-RAMP D	1,222.000	1,222.000	CY											1
40001		D	AREA 1### PAVEMENT & BASE ###	1.000	1.000	LS											1
40002		D	AREA 2### PAVEMENT & BASE ###	1.000	1.000	LS											2
40003		D	AREA 3### PAVEMENT & BASE ###	1.000	1.000	LS											3
40103		D	GRADED AGGREGATE BASE COURSE	1,652.000	1,652.000	TON											3

Pricing Details Removed

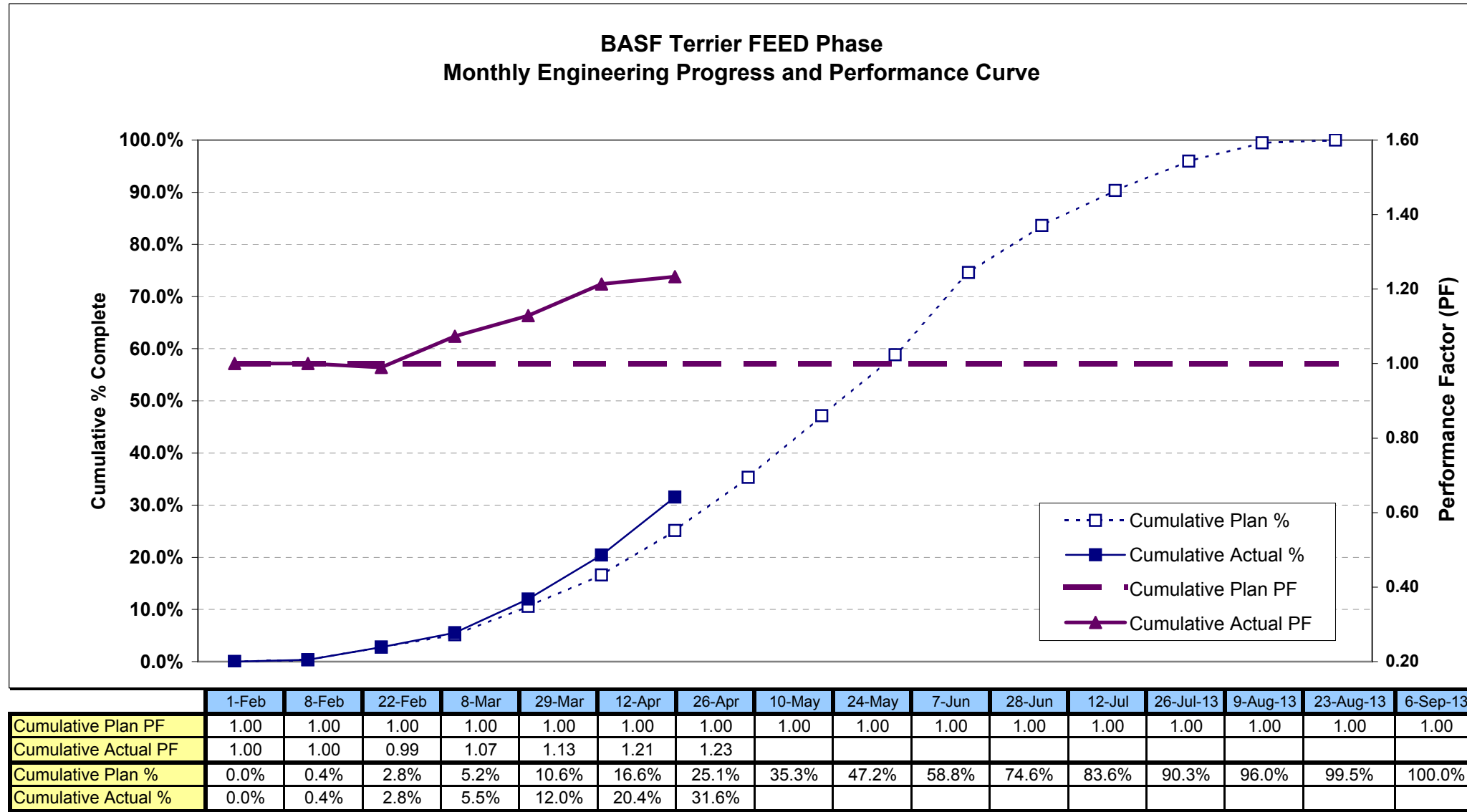

**BASF Terrier FEED Phase
Engineering Progress & Performance - PROCESS**

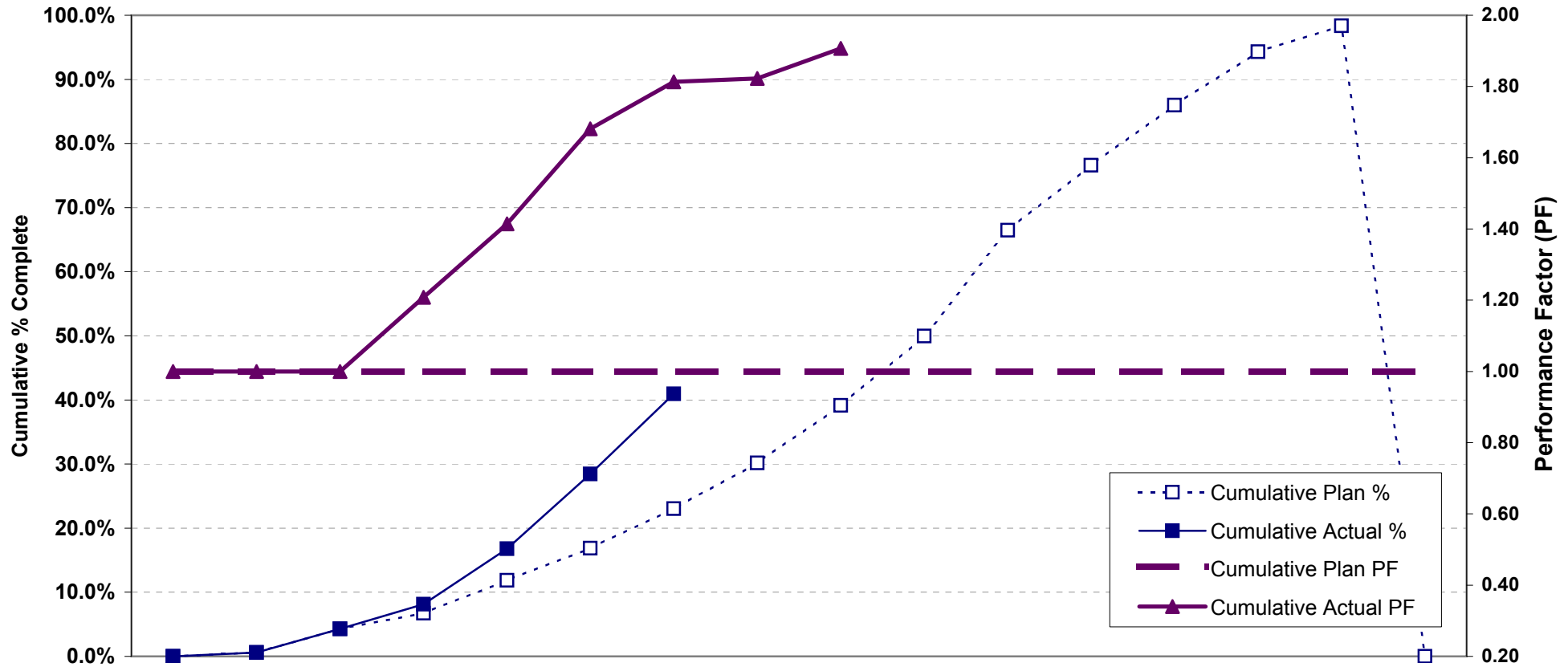

	1-Feb	8-Feb	22-Feb	8-Mar	29-Mar	12-Apr	26-Apr	10-May	24-May	7-Jun	28-Jun	12-Jul	26-Jul-13	9-Aug-13	23-Aug-13	6-Sep-13
Cumulative Plan PF	1.00	1.00	1.00	1.00	1.00	1.00	1.00	1.00	1.00	1.00	1.00	1.00	1.00	1.00	1.00	1.00
Cumulative Actual PF	1.00	1.00	1.00	1.21	1.41	1.68	1.81	1.82	1.91							
Cumulative Plan %	0.0%	0.6%	4.3%	6.7%	11.9%	16.9%	23.0%	30.2%	39.2%	50.0%	66.5%	76.6%	86.0%	94.3%	98.4%	0.0%
Cumulative Actual %	0.0%	0.6%	4.3%	8.1%	16.8%	28.4%	40.9%									

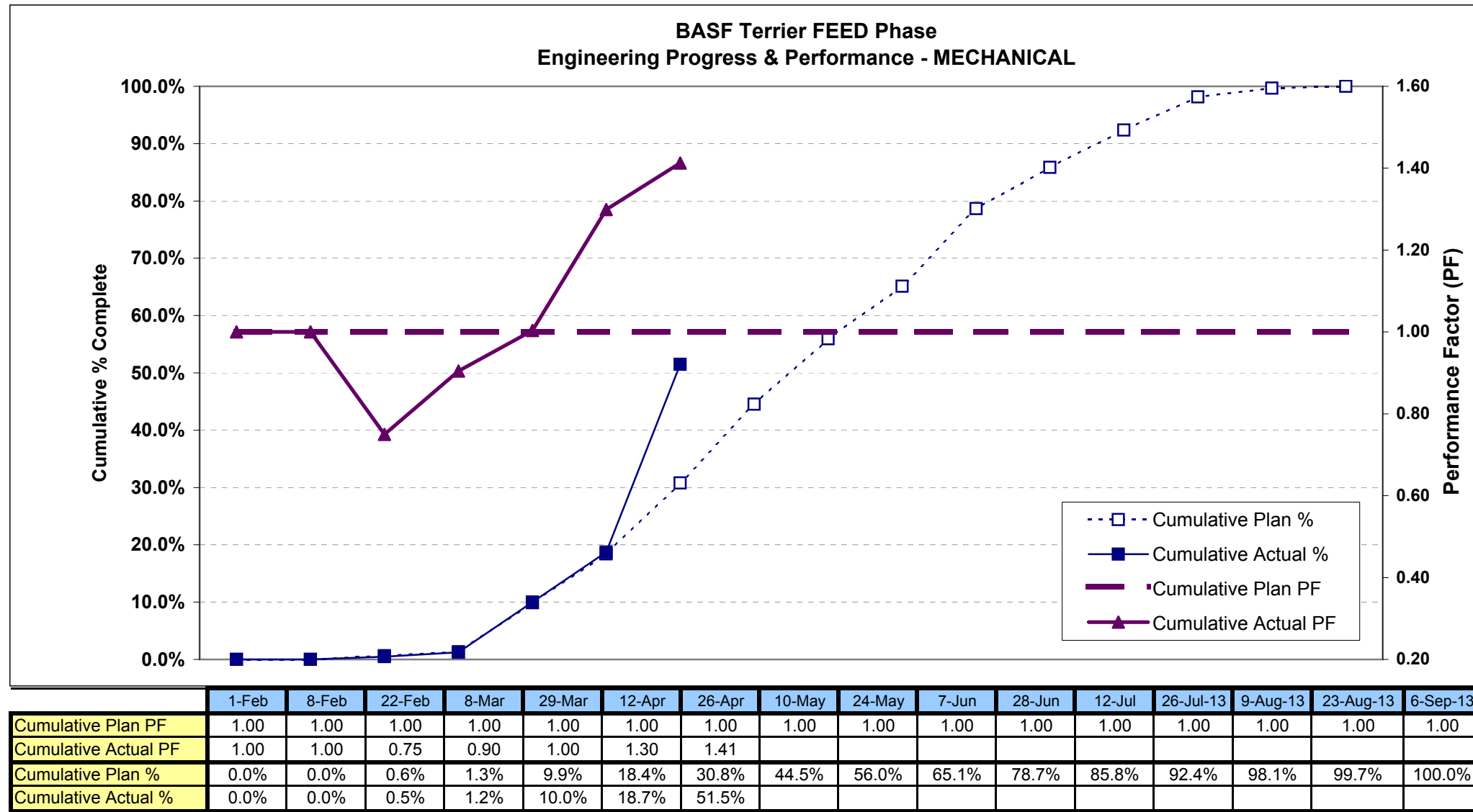

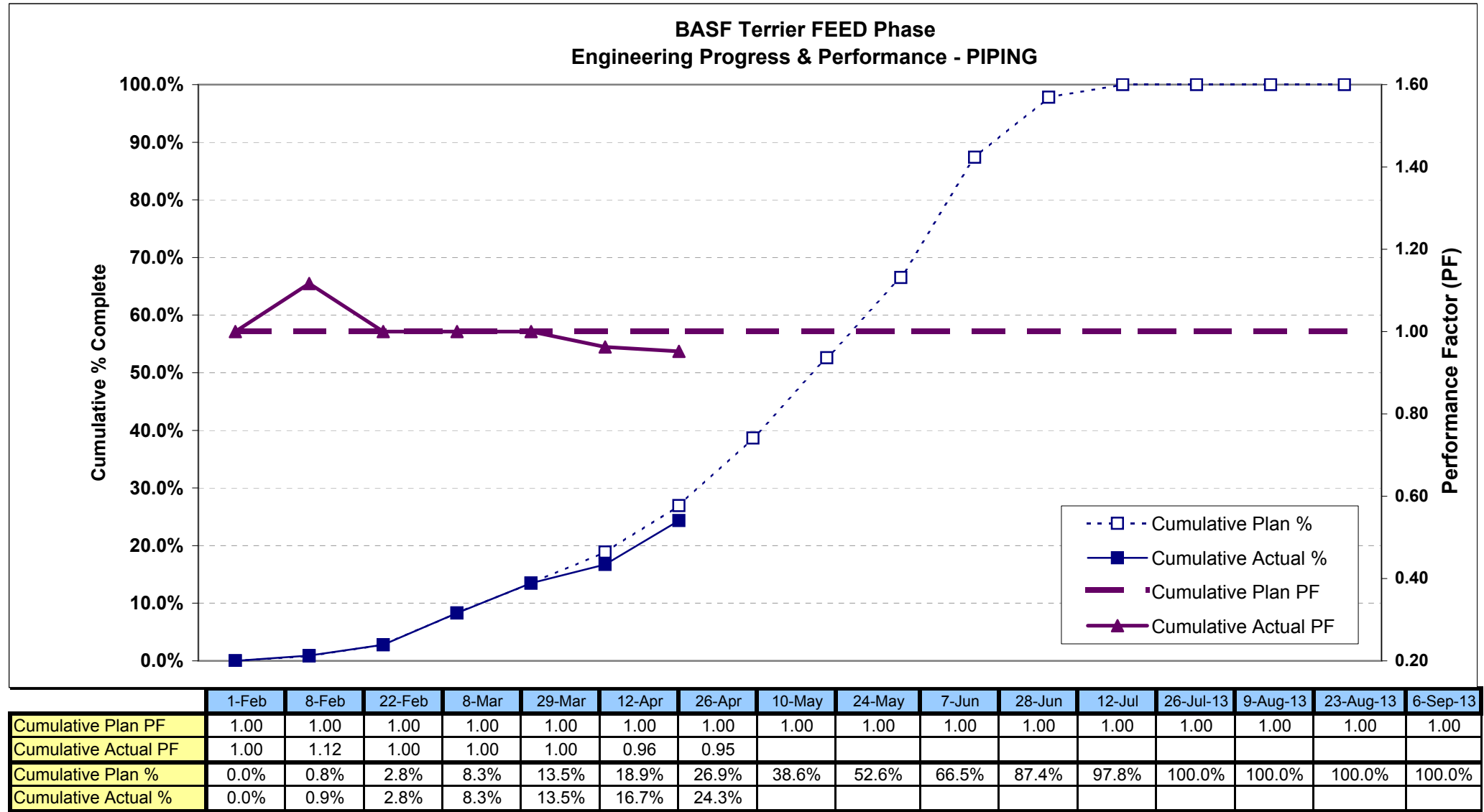

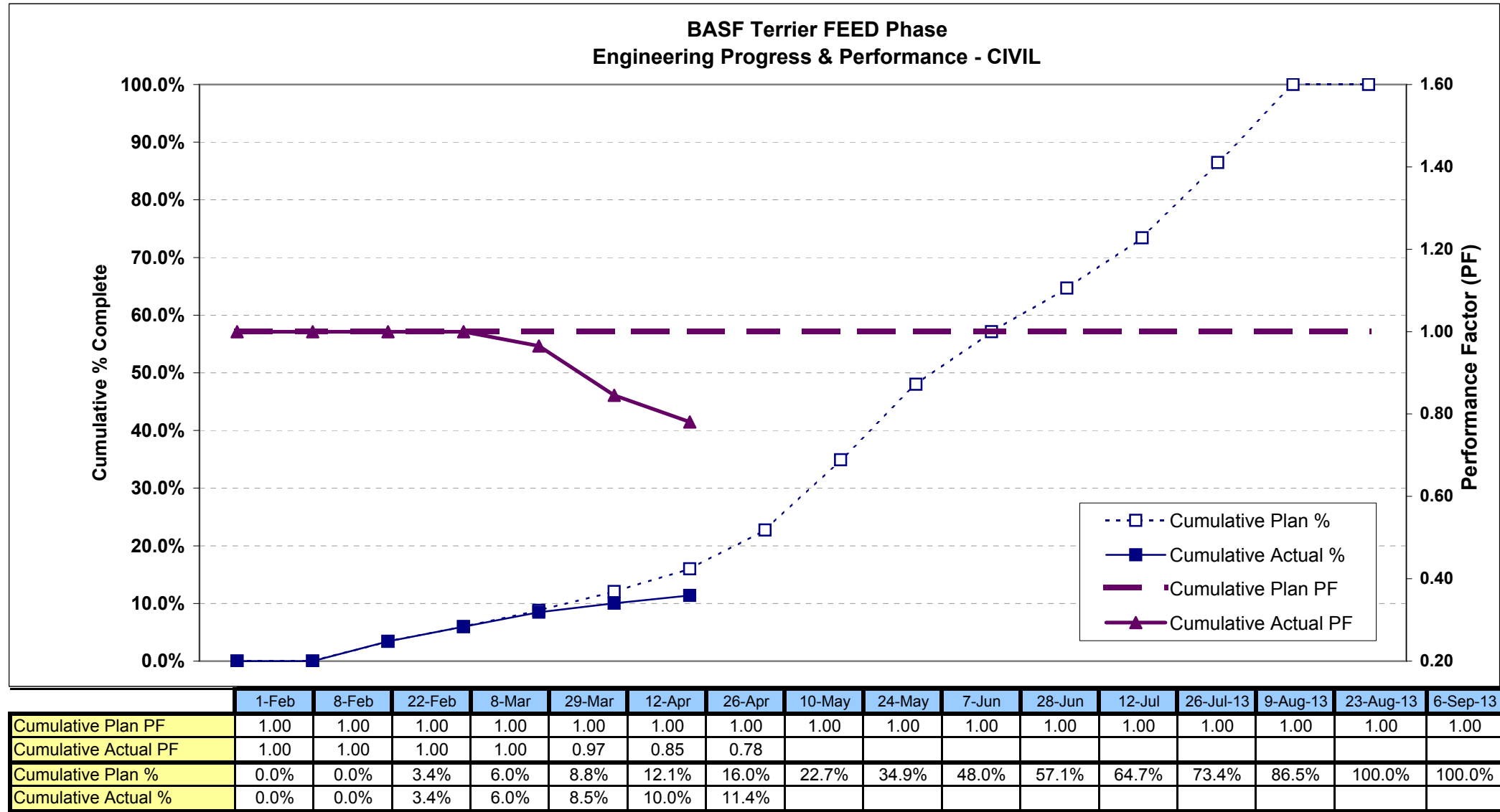

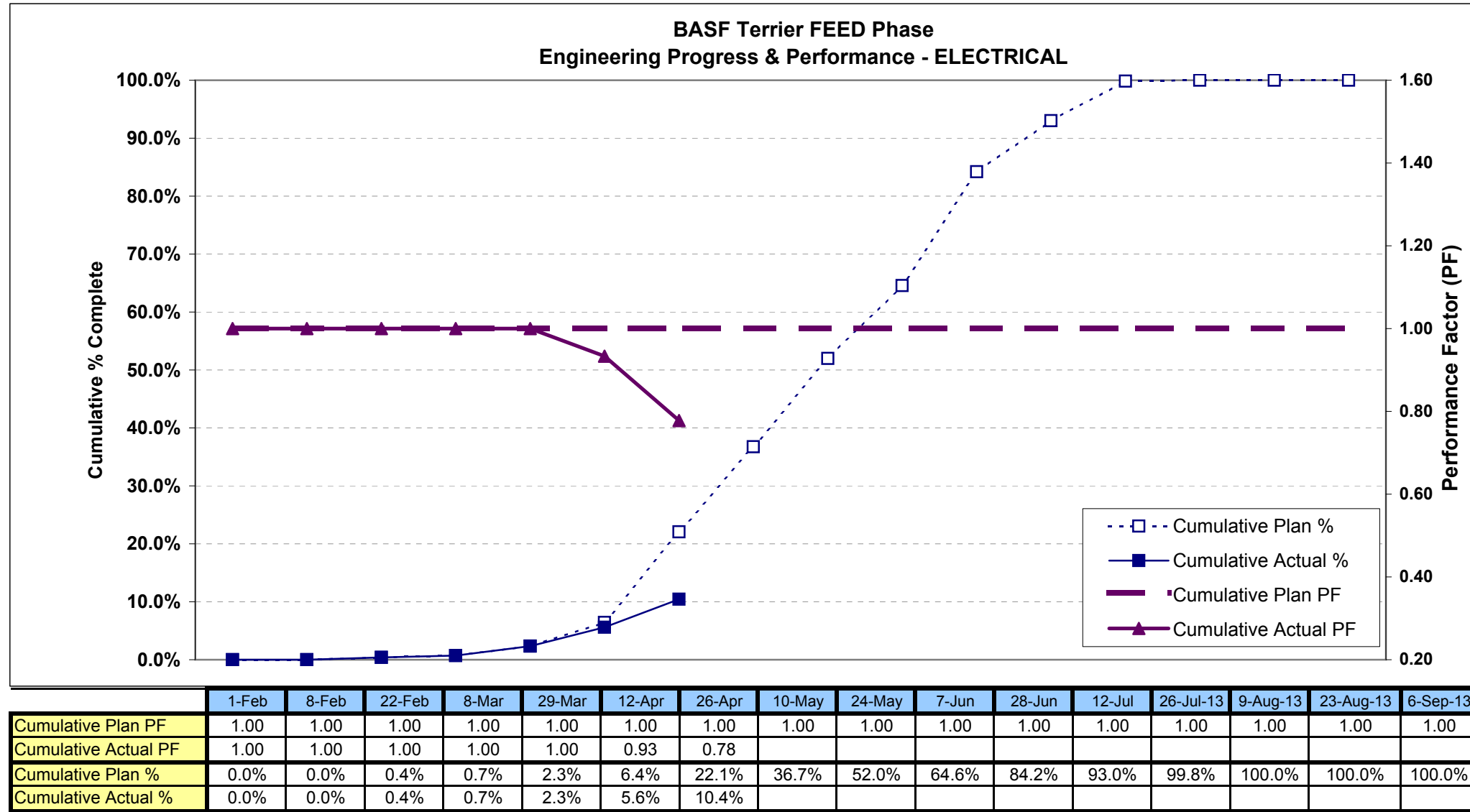

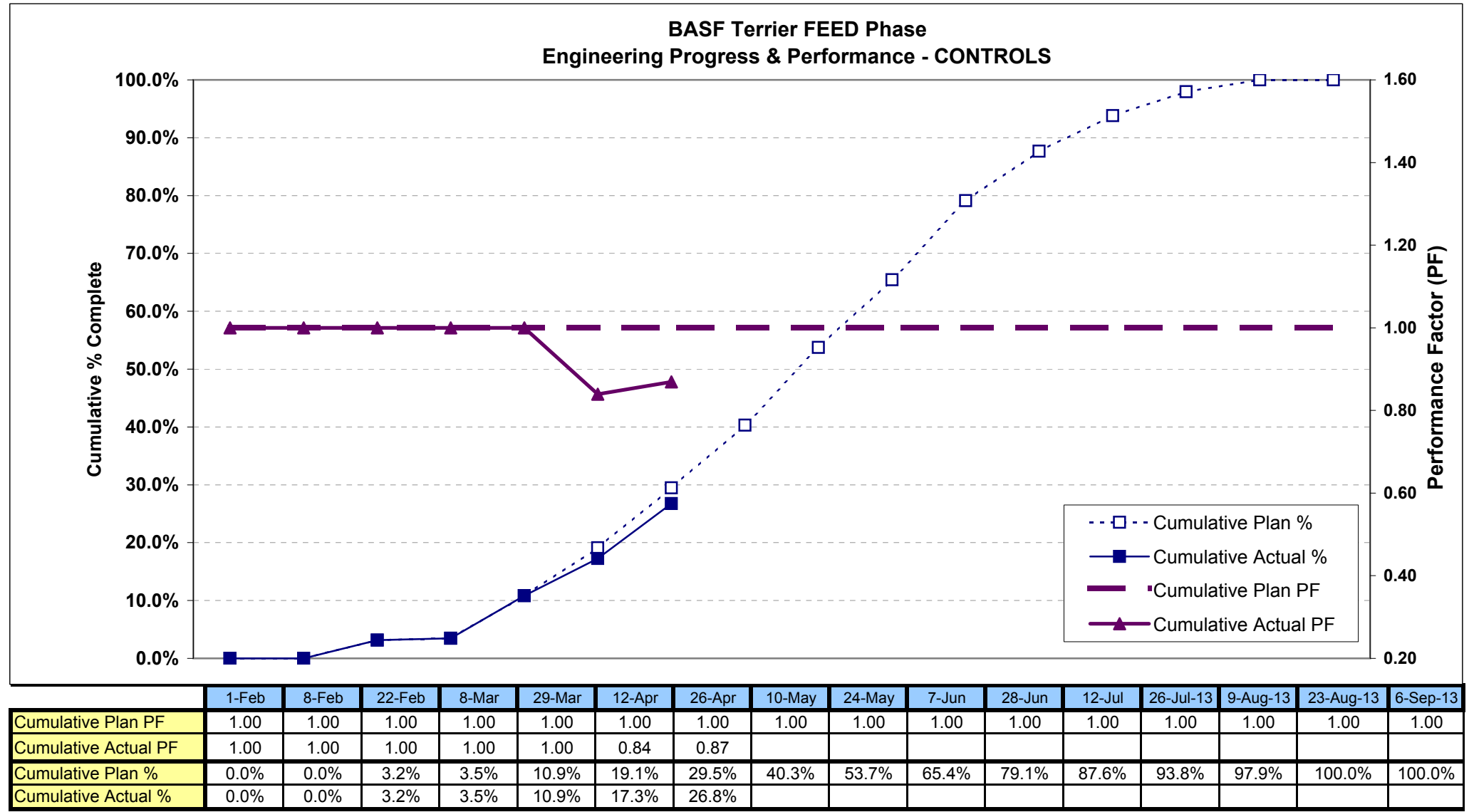

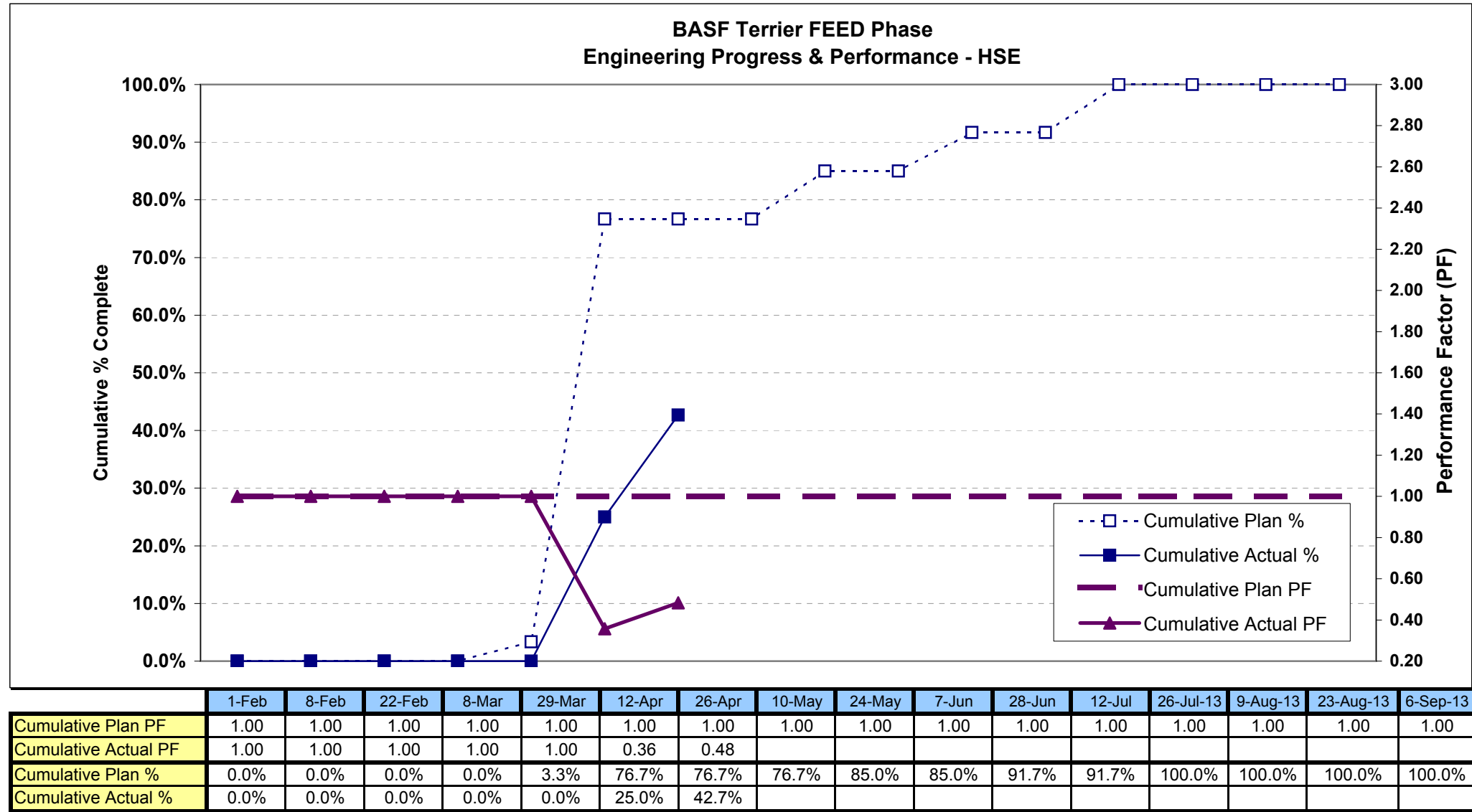

Activity ID	Activity Name	Original Duration	Start	Finish	Total Float	2018			
						Oct	Nov	Dec	
Green Line Extension Initial Baseline Schedule 20170908						457	01-Oct-18	30-Jun-20	226
Design						57	01-Oct-18	18-Dec-18	626
Roadway Bridges						40	11-Oct-18	10-Dec-18	74
Broadway (Bridge No. S-17-013)						40	11-Oct-18	10-Dec-18	74
DBWBR140	Broadway Bridge - RFC Design - MBTA Review & Comment	40	11-Oct-18	10-Dec-18	74				
Stations						50	09-Oct-18	18-Dec-18	245
Magoun Square						30	09-Oct-18	20-Nov-18	229
DSTA350	Magoun Square Station - RFC Design - Submit to MBTA for Review	30	09-Oct-18	20-Nov-18	229				
Gilman Square						30	09-Oct-18	20-Nov-18	220
DSTA450	Gilman Square Station - RFC Design - Submit to MBTA for Review	30	09-Oct-18	20-Nov-18	220				
College Ave						30	09-Oct-18	20-Nov-18	265
DSTA250	College Ave Station - RFC Design - Submit to MBTA for Review	30	09-Oct-18	20-Nov-18	265				
East Somerville						20	09-Oct-18	06-Nov-18	218
DSTA540	E Somerville Station - Intermediate Design - MBTA Review & Comment	20	09-Oct-18	06-Nov-18	218				
Ball Square						45	16-Oct-18	18-Dec-18	52
DSTA130	Ball Square Station - Intermediate Design - Submit to MBTA for Review	45	16-Oct-18	18-Dec-18	52				
Lechmere Station						40	23-Oct-18	17-Dec-18	41
DSTA650	Lechmere Station - RFC Design - Submit to MBTA for Review	40	23-Oct-18	17-Dec-18	41				
Retaining & Noise Walls						20	23-Oct-18	19-Nov-18	83
DRTW385	Retaining & Noise Walls - RFC Design - Submit to MBTA for Review	20	23-Oct-18	19-Nov-18	83				
Track						31	01-Oct-18	12-Nov-18	223
Medford & Union Square						25	09-Oct-18	12-Nov-18	135
DRWB2550	Medford & Union Line Track - RFC Design - Submit to MBTA for Review	25	09-Oct-18	12-Nov-18	135				
Rail Yard						20	01-Oct-18	26-Oct-18	225
DRWB2450	Rail Yard Track - RFC Design - MBTA Review & Comment	20	01-Oct-18	26-Oct-18	225				
Drainage - Segment 1						5	23-Oct-18	30-Oct-18	656
DDRA300	Drainage S1 - Final Design Docs - Submit to MBTA for Review	5	23-Oct-18	30-Oct-18	656				
Drainage - Segment 3						5	23-Oct-18	30-Oct-18	656
DDRA460	Drainage S3 - Final Design Docs - Submit to MBTA for Review	5	23-Oct-18	30-Oct-18	656				
Drainage - Segment 4						5	23-Oct-18	30-Oct-18	656
DDRA510	Drainage S4 - Final Design Docs - Submit to MBTA for Review	5	23-Oct-18	30-Oct-18	656				
Drainage - Segment 5						5	23-Oct-18	30-Oct-18	656
DDRA610	Drainage S5 - Final Design Docs - Submit to MBTA for Review	5	23-Oct-18	30-Oct-18	656				
Drainage - Segment 6						5	23-Oct-18	30-Oct-18	656
DDRA560	Drainage S6 - Final Design Docs - Submit to MBTA for Review	5	23-Oct-18	30-Oct-18	656				
Systems						34	09-Oct-18	23-Nov-18	268
Signaling						25	09-Oct-18	12-Nov-18	53
DUDP1030	Signaling - RFC Design - Submit to MBTA for Review	25	09-Oct-18	12-Nov-18	53				
Power & OCS						25	09-Oct-18	12-Nov-18	110
DOCS125	Power & OCS - RFC Design - Submit to MBTA for Review	25	09-Oct-18	12-Nov-18	110				
Communications						25	22-Oct-18	23-Nov-18	268
DUDP830	Communications - RFC Design - Submit to MBTA for Review	25	22-Oct-18	23-Nov-18	268				
Community Path						40	08-Oct-18	05-Dec-18	268
DCMP210	Community Path - Pre-RFC Design - MBTA, 3rd Party, Govt Review & Comment	40	08-Oct-18	05-Dec-18	268				
Roadways & Traffic Improvements						10	10-Oct-18	24-Oct-18	638
DRDW185	Roadways - Final Design Docs - Submit to MBTA for Review	5	10-Oct-18	17-Oct-18	638				
DRDW190	Roadways - Final Design Docs - MBTA Review & Approve	5	17-Oct-18	24-Oct-18	638				
Procurement						232	02-Oct-18	09-Oct-19	56
Communications Equipment						232	02-Oct-18	09-Oct-19	56
PRCME120	Communications Equipment - Place Order	2	02-Oct-18	04-Oct-18	56				
PRCME100	Communications Equipment - Fabricate & Deliver	230	04-Oct-18	09-Oct-19	56				
Fare Collection System Equipment						202	02-Oct-18	21-Aug-19	60
PRFCS120	Fare Collection System Equipment - Place Order	2	02-Oct-18	04-Oct-18	60				
PRFCS100	Fare Collection System Equipment - Fabricate & Deliver	200	04-Oct-18	21-Aug-19	60				
Feeder Cabling						142	02-Oct-18	17-May-19	94

■ Actual Work ■ Critical Remaining Work
■ Remaining Work ◆ Milestone



Green Line Extension Proposal Development Schedule

Page: 1 of 2 Data Date: 28-Sep-17 Print: 09-Sep-17

Activity ID	Activity Name	Original Duration	Start	Finish	Total Float	2018		
						Oct	Nov	Dec
PRCBL120	Feeder Cabling - Place Order	2	02-Oct-18	04-Oct-18	94	■ Feeder Cabling - Place Order		
PRCBL100	Feeder Cabling - Fabricate & Deliver	140	04-Oct-18	17-May-19	94	■ Feeder Cabling - Place Order		
Trackwork		122	11-Oct-18	29-Apr-19	40	■ Trackwork - Place Order		
PRTRK120	Trackwork - Place Order	2	11-Oct-18	12-Oct-18	40	■ Trackwork - Place Order		
PRTRK100	Trackwork - Fabricate & Deliver	120	15-Oct-18	29-Apr-19	40	■ Trackwork - Place Order		
Construction		397	02-Oct-18	30-Jun-20	81			
Segment 1		320	23-Oct-18	25-Mar-20	143			
Drainage		320	23-Oct-18	25-Mar-20	143			
C1DRA100	Drainage S1 - SUMMARY	320	23-Oct-18	25-Mar-20	143	■ Main Drainage - Excavate & Install		
C1DRA135	Main Drainage - Excavate & Install	20	23-Oct-18	27-Nov-18	127	■ Main Drainage - Excavate & Install		
Segment 2		51	04-Oct-18	26-Dec-18	0			
Earthwork, Clearing & Grubbing		51	04-Oct-18	26-Dec-18	0			
C2CGE110	Earthwork / Access Road - Segment 2	51	04-Oct-18	26-Dec-18	0	■ Ear		
Segment 3		382	23-Oct-18	30-Jun-20	81			
Earthwork, Clearing & Grubbing		94	23-Oct-18	26-Mar-19	33			
C3CGE110	Earthwork - Segment 3	94	23-Oct-18	26-Mar-19	33	■		
Drainage		382	23-Oct-18	30-Jun-20	81			
C3DRA100	Drainage S3 - SUMMARY	382	23-Oct-18	30-Jun-20	81	■		
C3DRA105	Main Drainage - Excavate & Install	46	23-Oct-18	11-Jan-19	33	■		
Segment 4		82	02-Oct-18	13-Feb-19	396			
Utilities		15	23-Oct-18	15-Nov-18	448			
C4UT115	Utilities - Relocate Overhead ELEC STA 208+25 MB-WB	10	23-Oct-18	08-Nov-18	453	■ Utilities - Relocate Overhead ELEC STA 208+25 MB-WB		
C4UT120	Utilities - Relocate Overhead ELEC STA 208+50 MB-WB	10	23-Oct-18	08-Nov-18	453	■ Utilities - Relocate Overhead ELEC STA 208+50 MB-WB		
C4UT125	Utilities - Relocate Underground ELEC STA 210+50 MB-WB	15	23-Oct-18	15-Nov-18	448	■ Utilities - Relocate Underground ELEC STA 210+50 MB-WB		
Drainage		67	23-Oct-18	13-Feb-19	275			
C4DRA100	Drainage S4 - SUMMARY	67	23-Oct-18	13-Feb-19	275	■		
C4DRA115	Main Drainage - Excavate & Install	67	23-Oct-18	13-Feb-19	275	■		
Viaducts		37	02-Oct-18	03-Dec-18	285			
Medford (MBV)		37	02-Oct-18	03-Dec-18	285			
Medford Branch South		37	02-Oct-18	03-Dec-18	285			
C4MBV340	Medford Viaduct (MBV) (Piers 22 - 24) - Steep Pipe Pile Caps	13	02-Oct-18	19-Oct-18	69	■ Medford Viaduct (MBV) (Piers 22 - 24) - Steep Pipe Pile Caps		
C4MBV295	Medford Viaduct (MBV) (Piers 25 - 29, 32) - Drilled Shafts	24	19-Oct-18	03-Dec-18	285	■ Medford Viaduct (MBV) (Piers 25 - 29, 32)		
C4MBV360	Medford Viaduct (MBV) (Piers 17 - 19) - Drilled Shaft Caps	15	23-Oct-18	15-Nov-18	40	■ Medford Viaduct (MBV) (Piers 17 - 19) - Drilled Shaft Caps		
Medford Branch North		10	19-Oct-18	06-Nov-18	285			
C4MBV395	Medford Viaduct (MBV) (Piers 33 - 37) - Drilled Shaft Piers	10	19-Oct-18	06-Nov-18	285	■ Medford Viaduct (MBV) (Piers 33 - 37) - Drilled Shaft Piers		
Segment 5 - VMF		127	23-Oct-18	17-May-19	111			
Clearing & Grubbing		127	23-Oct-18	17-May-19	111			
C5STR140	VMF - Vehicle Maint Building - Complete Site Clearing & Grading	102	23-Oct-18	09-Apr-19	35	■		
C5STR150	VMF - Clearing, Excavation, Site Prep - SUMMARY	127	23-Oct-18	17-May-19	111	■		
Segment 6 - Union Square		244	02-Oct-18	29-Oct-19	50			
Drainage		229	23-Oct-18	29-Oct-19	50			
C6DRA100	Drainage S6 (Union Sq Branch) - SUMMARY	229	23-Oct-18	29-Oct-19	50	■ Union Sq Line Main Drainage - Excavate & Install		
C6DRA115	Union Sq Line Main Drainage - Excavate & Install	5	23-Oct-18	01-Nov-18	224	■ Union Sq Line Main Drainage - Excavate & Install		
Viaducts		178	02-Oct-18	16-Jul-19	66			
Union Square EB (UEV)		178	02-Oct-18	16-Jul-19	66			
C6UEV100	Union Square EB Viaduct (UEV) - SUMMARY	178	02-Oct-18	16-Jul-19	66	■ Union Square EB Viaduct (UEV) - Steel Pipe Piles		
C6UEV105	Union Square EB Viaduct (UEV) - Steel Pipe Piles	24	02-Oct-18	07-Nov-18	66	■ Union Square EB Viaduct (UEV) - Steel Pipe Piles		

■ Actual Work ■ Critical Remaining Work
■ Remaining Work ◆ Milestone



Green Line Extension Proposal Development Schedule

Page: 2 of 2 Data Date: 28-Sep-17 Print: 09-Sep-17

Segment 6 - Union Square

0+00

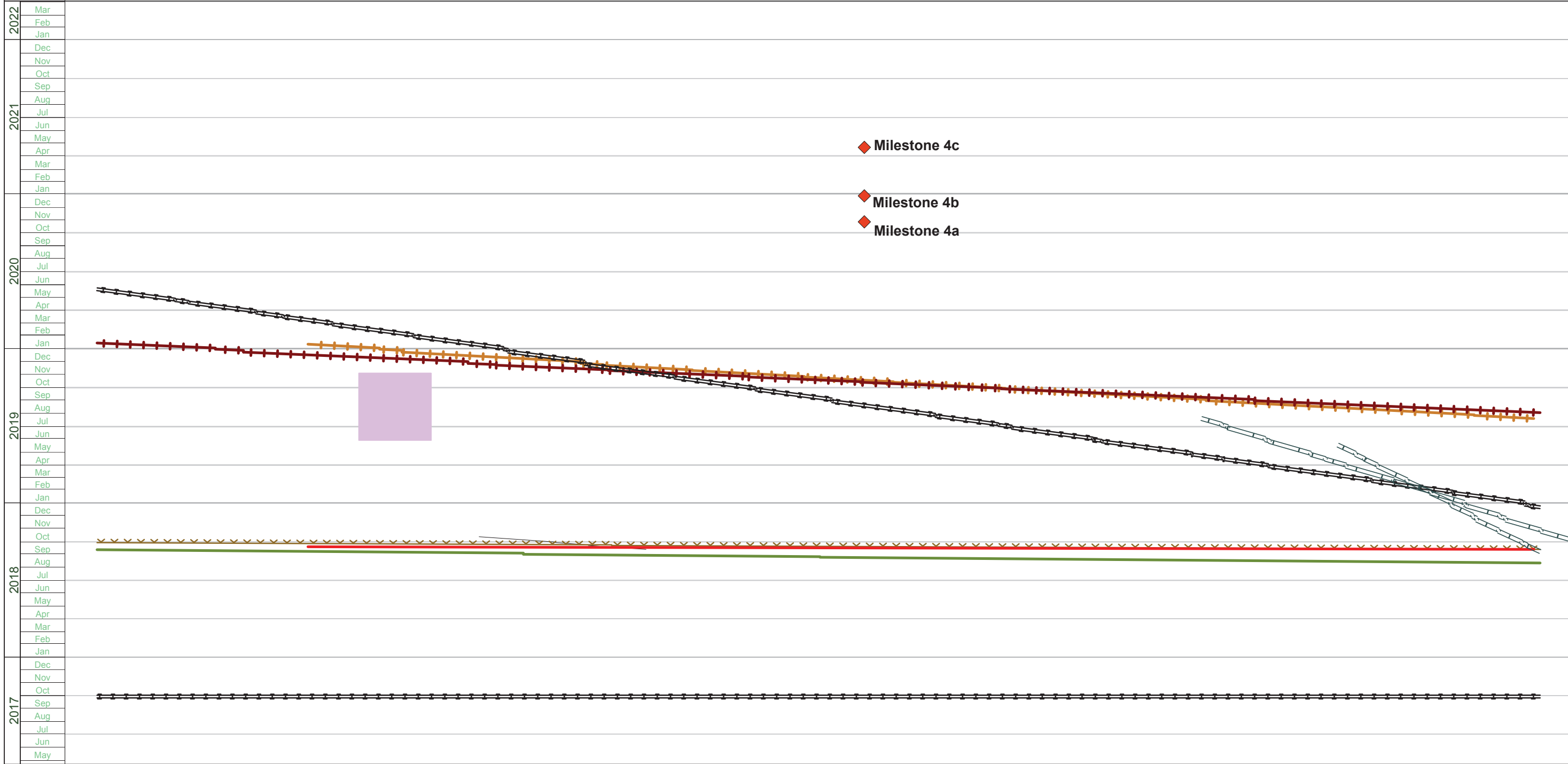

Clearing & Grubbing		Viaducts		Systems	
Earthwork		Union Square Station		GLXFMS	
Main Drainage		Track - Un Sq EB			
Retaining Wall		Track - Un Sq WB			



Project: GLX Constructors
Printed: 08.30.2017

APPENDIX 6

GLX Activity Codes

GLX - Activity Codes

EPS/Project

Activity Code

GLX DB-21 Green Line Extension Initial Baseline Schedule 20170908

GLX Area / Segment

<u>Code Value</u>	<u>Description</u>
S1	Segment 1
S2	Segment 2
S3	Segment 3
S4	Segment 4
S5	Segment 5 VMF
S6	Segment 6 Union Square Branch
PW	Project Wide

GLC Critical Path

<u>Code Value</u>	<u>Description</u>
CP1	CP1
CP2	CP2
CP3	CP3

GLX Change Order

GLX Construction / Installation Category

<u>Code Value</u>	<u>Description</u>
CLGR	Clearing & Grubbing
CPTH	Community Paths
DR	Drainage
FN	Fencing
PB	Pedestrian Bridges
PMPS	Pump Stations
RRBR	Railroad Bridge
RWNB	Retaining Walls / Noise Barriers
RWTI	Roadway & Traffic Improvements
RWBRs	Roadway Bridges - Specific
RWBRs.BW	Broadway (Bridge No. S-17-013)
RWBRs.CD	Cedar St (Somerville) (Bridge No. S-17-012)
RWBRs.CA	College Ave (Medford) (Bridge No. M-12-012)
RWBRs.LW	Lowell St (Somerville) (Bridge No. S-17-011)
RWBRs.MD	Medford St (Somerville) (Bridge No. S-17-007)
RWBRs.SS	Schod St (Somerville) (Bridge No. S-17-008)
RWBRs.WS	Walnut St (Somerville) (Bridge No. S-17-006)
RWB	Roadway Bridges - General
STA	Stations
STA.Ball	Ball Square

GLX - Activity Codes

EPS/Project

Activity Code

STA.Cdl	College Ave
STA.Mago	Magoun Square
STA.Gilm	Gilman Square
STA.ESom	E Somerville
STA.Lech	Lechmere
STA.Unio	Union Square
STRU	Structures
SYS	Systems
TRK	Track
UND	Underpasses
UTIL	Utilities
UTBR	Utility Bridge
VMF	Vehicle Maintenance Facility
VMF.TOB	Transportation Office Building
VMF.VMB	Vehicle Maintenance Building
VIAD	Viaducts
VIAD.LEV	Lechmere Viaduct
VIAD.MBV	Medford Viaduct
VIAD.UWV	Union Sq WB Viaduct
VIAD.UEV	Union Sq EB Viaduct
(New)	(New Code Value)

GLX Delivery

<u>Code Value</u>	<u>Description</u>
MAT	Material
EQP	Equipment

GLX Design

<u>Code Value</u>	<u>Description</u>
PW	Project Wide
PW.CLGR	Clearing & Grubbing
PW.PP	Community Paths
PW.DR	Drainage
PW.FN	Fencing
PW.NB	Noise Barriers
PW.RW	Retaining Walls
PW.RDW	Roadways
PW.TRK	Track
PB	Pedestrian Bridges
RRB	Railroad Bridge
RRB.WS	Washington St

GLX - Activity Codes

EPS/Project

Activity Code

RWB	Roadway Bridges
RWB.BW	Broadway (Bridge No. S-17-013)
RWB.CD	Cedar St (Somerville) (Bridge No. S-17-012)
RWB.CA	College Ave (Medford) (Bridge No. M-12-012)
RWB.LW	Lowell St (Somerville) (Bridge No. S-17-011)
RWB.MD	Medford St (Somerville) (Bridge No. S-17-007)
RWB.SS	Schod St (Somerville) (Bridge No. S-17-008)
RWB.WS	Walnut St (Somerville) (Bridge No. S-17-006)
STA	Stations
STA.Ball	Ball Square
STA.Cdl	College Ave
STA.Mago	Magoun Square
STA.Gilm	Gilman Square
STA.ESom	E Somerville
STA.Lech	Lechmere
STA.Unio	Union Square
STRU	Structures
VIA	Viaducts
UTBR	Utility Bridges
UTIL	Utilities
UND	Underpasses
SYS	Systems
VMF	Vehicle Maintenance Facility
VMF.TOB	Transportation Office Building
VMF.VMB	Vehicle Maintenance Building

GLX Drilling Subs

<u>Code Value</u>	<u>Description</u>
DRLSBS	Drilling Subs

GLX Estimating Code

<u>Code Value</u>	<u>Description</u>
100000	MOT
110000	Demo & Removals
120000	Erosion Control & Earthwork
130000	Drainage
140000	Pavement & Base
150000	Bridges
160000	Walls
170000	Railroad Work
180000	VMF

GLX - Activity Codes

EPS/Project

Activity Code

190000	Stations
200000	Systems
210000	Misc Roadway
220000	Community Path
230000	Landscaping
240000	Roadway Electrical
250000	Utility Relocations
300000	Haz Material Remediation
800000	Holding Accounts
995000	Supplemental Direct Cost Items
997000	Indirect Costs

GLX Milestone

<u>Code Value</u>	<u>Description</u>
MS	Major Milestones
L1	Level 1 Executive Management
L2	Level 2 Project Management
L3	Level 3 Field Management

GLX Phase

<u>Code Value</u>	<u>Description</u>
DSN	Design
CDRL	Contract Deliverables
PRC	Procurement
PreC	Pre-Construction
CON	Construction
TST	Testing / Commissioning
CLS	Closeout

GLX Price Item

GLX Procurement/Fabrication

<u>Code Value</u>	<u>Description</u>
MAT	Material
EQP	Equipment

GLX Responsibility

<u>Code Value</u>	<u>Description</u>
GLX	Greenline Constructors
3rd	3rd Party
MBTA	Mass Bay Transit Authority
MassDOT	Mass Dept of Transportation
MBTA3rd	Both MBTA & 3rd Party

GLX - Activity Codes

EPS/Project

Activity Code

GLX Review / Acceptance

<u>Code Value</u>	<u>Description</u>
MBTA	by MBTA
3rd	by 3rd Party, Govt, etc.
MB3rd	by MBTA & 3rd Party

GLX Risk Analysis

<u>Code Value</u>	<u>Description</u>
MDCP1	Medford Branch CP1
MDCP2	Medford Branch CP2
MDCP3	Medford Branch CP3
USCP1	Union Square CP1
USCP2	Union Square CP2
USCP3	Union Square CP3

GLX Standard Cost Category

<u>Code Value</u>	<u>Description</u>
10	Guideway & Track Elements
20	Stations, Stops, Terminals, Intermodal
30	Support Facilities: Yards, Shops, Admin Bldgs
40	Sitework & Special Conditions
50	Systems
60	ROW, Land, Existing Improvements
70	Vehicles
80	Professional Services
90	Unallocated Contingency
100	Finance Charges

GLX Submittal

GLX Summary Level

<u>Code Value</u>	<u>Description</u>
LVL1	Summary Level 1
LVL2	Summary Level 2
LVL3	Summary Level 3
LVL4	Summary Level 4
LVL5	Summary Level 5
LVL6	Summary Level 6

GLX TILOS

<u>Code Value</u>	<u>Description</u>
T	Show TILOS for MD and VMF

GLX - Activity Codes

EPS/Project

Activity Code

TUS	Show TILOS for Union Square
-----	-----------------------------

GLX WBS Summary

<u>Code Value</u>	<u>Description</u>
WBS	WBS Summary
LVL1	Summary Level 1
LVL2	Summary Level 2
LVL3	Summary Level 3
LVL4	Summary Level 4
LVL5	Summary Level 5
LVL6	Summary Level 6

GLX Work Type

<u>Code Value</u>	<u>Description</u>
ENG	Engineering
SYS	Systems
MBTA	MBTA ReviApv
CDRL	CDRL
TRKW	Trackwork
PROC	Procurement
COMS	Communications
OCS	CAT System
TPS	Traction Power
TC	Train Control
TST	Testing
STA	Stations
MD	Main Drainage
MSs	Milestones
UTIL	Utility Reloc
CG	Cleaning & Grubbing
STR	Structures
RWBR	Roadway Bridge
EW	Earthwork
RW	Roadway
DEMO	Demolition
ROW	ROW
RWs	Retaining & Noise Walls
DB	Ductbank
NW	Noise Walls
CONS	Construction
CPTH	Community Path

GLX - Activity Codes

EPS/Project

Activity Code

PRMS	Permits
RRBR	Railroad Bridge
PBR	Pedestrian Bridge
VIAD	Viaduct
TD	Track Drainage

APPENDIX 7

Work Breakdown Schedule

WBS Code	WBS Name	Project ID	Project Status
GLX DB-21	Green Line Extension Initial Baseline Schedule 20170!	GLX DB-21	Active
GLX DB-21.1	Milestones	GLX DB-21	Active
GLX DB-21.2	Design	GLX DB-21	Active
GLX DB-21.2.1	Project Wide	GLX DB-21	Active
GLX DB-21.2.1.6	Documentation / Pre-Design Plan	GLX DB-21	Active
GLX DB-21.2.2	Roadway Bridges	GLX DB-21	Active
GLX DB-21.2.2.10	Medford St (Somerville) (Bridge No. S-17-007)	GLX DB-21	Active
GLX DB-21.2.2.1	Broadway (Bridge No. S-17-013)	GLX DB-21	Active
GLX DB-21.2.2.5	Cedar St (Somerville) (Bridge No. S-17-012)	GLX DB-21	Active
GLX DB-21.2.2.7	College Ave (Medford) (Bridge No. M-12-012)	GLX DB-21	Active
GLX DB-21.2.2.3	School St (Somerville) (Bridge No. S-17-008)	GLX DB-21	Active
GLX DB-21.2.2.4	Walnut St (Somerville) (Bridge No. S-17-006)	GLX DB-21	Active
GLX DB-21.2.2.6	Lowell St (Somerville) (Bridge No. S-17-011)	GLX DB-21	Active
GLX DB-21.2.9	Stations	GLX DB-21	Active
GLX DB-21.2.9.10	Magoun Square	GLX DB-21	Active
GLX DB-21.2.9.5	Gilman Square	GLX DB-21	Active
GLX DB-21.2.9.2	College Ave	GLX DB-21	Active
GLX DB-21.2.9.1	East Somerville	GLX DB-21	Active
GLX DB-21.2.9.3	Ball Square	GLX DB-21	Active
GLX DB-21.2.9.7	Lechmere Station	GLX DB-21	Active
GLX DB-21.2.9.8	Union Square	GLX DB-21	Active
GLX DB-21.2.6	Viaducts	GLX DB-21	Active
GLX DB-21.2.6.1	Lechmere (LEV) Pkg 2	GLX DB-21	Active
GLX DB-21.2.6.2	Lechmere (LEV) Pkg 1	GLX DB-21	Active
GLX DB-21.2.6.10	Medford (MBV)	GLX DB-21	Active
GLX DB-21.2.6.6	Union Square EB (UEV)	GLX DB-21	Active
GLX DB-21.2.6.3	Union Square WB (UWV)	GLX DB-21	Active
GLX DB-21.2.15	Retaining Walls (Early)	GLX DB-21	Active
GLX DB-21.2.8	Retaining & Noise Walls	GLX DB-21	Active
GLX DB-21.2.18	Track	GLX DB-21	Active
GLX DB-21.2.18.2	Medford & Union Square	GLX DB-21	Active
GLX DB-21.2.18.1	Rail Yard	GLX DB-21	Active
GLX DB-21.2.12	Drainage - Segment 1	GLX DB-21	Active
GLX DB-21.2.11	Drainage - Segment 2	GLX DB-21	Active
GLX DB-21.2.17	Drainage - Segment 3	GLX DB-21	Active
GLX DB-21.2.19	Drainage - Segment 4	GLX DB-21	Active
GLX DB-21.2.23	Drainage - Segment 5	GLX DB-21	Active
GLX DB-21.2.22	Drainage - Segment 6	GLX DB-21	Active
GLX DB-21.2.14	Railroad Bridge	GLX DB-21	Active
GLX DB-21.2.14.3	Washington St Bridge	GLX DB-21	Active
GLX DB-21.2.5	Systems	GLX DB-21	Active
GLX DB-21.2.5.4	Signaling	GLX DB-21	Active
GLX DB-21.2.5.3	Power & OCS	GLX DB-21	Active
GLX DB-21.2.5.9	Communications	GLX DB-21	Active
GLX DB-21.2.4	VMF	GLX DB-21	Active
GLX DB-21.2.4.10	Vehicle Maintenance Building	GLX DB-21	Active
GLX DB-21.2.4.6	Transportation Office Building	GLX DB-21	Active
GLX DB-21.2.13	Community Path	GLX DB-21	Active
GLX DB-21.2.21	Roadways & Traffic Improvements	GLX DB-21	Active
GLX DB-21.3	Contract Deliverables / Submittals	GLX DB-21	Active
GLX DB-21.3.1	Plans	GLX DB-21	Active
GLX DB-21.3.1.1	Project Management Plan	GLX DB-21	Active
GLX DB-21.3.1.2	Comprehensive Environmental Protection Program	GLX DB-21	Active
GLX DB-21.4	Procurement	GLX DB-21	Active
GLX DB-21.4.14	Steel Girders	GLX DB-21	Active
GLX DB-21.4.9	Special Trackwork	GLX DB-21	Active
GLX DB-21.4.1	Traction Power Substation	GLX DB-21	Active
GLX DB-21.4.7	Train Control Signaling Cabinets & Equipment	GLX DB-21	Active
GLX DB-21.4.6	Catenary Components	GLX DB-21	Active
GLX DB-21.4.11	Communications Equipment	GLX DB-21	Active
GLX DB-21.4.8	Fare Collection System Equipment	GLX DB-21	Active
GLX DB-21.4.12	Feeder Cabling	GLX DB-21	Active
GLX DB-21.4.3	Pre-Cast Noise Wall Panels	GLX DB-21	Active
GLX DB-21.4.13	Trackwork	GLX DB-21	Active
GLX DB-21.4.10	Maintenance Facility Equipment	GLX DB-21	Active
GLX DB-21.4.4	Concrete Beams	GLX DB-21	Active
GLX DB-21.7	Pre-Construction	GLX DB-21	Active
GLX DB-21.7.2	Permits	GLX DB-21	Active
GLX DB-21.7.2.1	Obtained by MBTA	GLX DB-21	Active
GLX DB-21.7.2.3	To Be Obtained by GLXC	GLX DB-21	Active
GLX DB-21.7.4	Studies	GLX DB-21	Active
GLX DB-21.5	Construction	GLX DB-21	Active
GLX DB-21.5.1	Project Wide	GLX DB-21	Active
GLX DB-21.5.8	Segment 1	GLX DB-21	Active
GLX DB-21.5.8.9	Earthwork, Clearing & Grubbing	GLX DB-21	Active
GLX DB-21.5.8.10	Utilities	GLX DB-21	Active
GLX DB-21.5.8.2	Retaining & Noise Walls	GLX DB-21	Active
GLX DB-21.5.8.5	Drainage	GLX DB-21	Active
GLX DB-21.5.8.3	Roadway Bridge	GLX DB-21	Active

WBS Code	WBS Name	Project ID	Project Status
GLX DB-21.5.8.3.22	College Ave (Medford) (Bridge No. M-12-012)	GLX DB-21	Active
GLX DB-21.5.8.16	Pedestrian Bridge - College Ave	GLX DB-21	Active
GLX DB-21.5.8.1	Station	GLX DB-21	Active
GLX DB-21.5.8.1.22	College Ave	GLX DB-21	Active
GLX DB-21.5.8.4	Track	GLX DB-21	Active
GLX DB-21.5.8.4.1	Commuter Track 1 (EB) (Sta. 238+00 - 200+00)	GLX DB-21	Active
GLX DB-21.5.8.4.2	Commuter Track 2 (WB) (Sta. 238+00 - 200+00)	GLX DB-21	Active
GLX DB-21.5.8.4.3	Medford Branch EB(Sta. 374+00 - 344+00)	GLX DB-21	Active
GLX DB-21.5.8.4.4	Medford Branch WB (Sta. 374+00 - 344+00)	GLX DB-21	Active
GLX DB-21.5.8.6	Systems	GLX DB-21	Active
GLX DB-21.5.8.6.1	OCS	GLX DB-21	Active
GLX DB-21.5.8.6.9	TPSS	GLX DB-21	Active
GLX DB-21.5.8.6.3	Signaling	GLX DB-21	Active
GLX DB-21.5.8.6.4	Communications	GLX DB-21	Active
GLX DB-21.5.11	Segment 2	GLX DB-21	Active
GLX DB-21.5.11.12	Utilities	GLX DB-21	Active
GLX DB-21.5.11.11	Earthwork, Clearing & Grubbing	GLX DB-21	Active
GLX DB-21.5.11.8	Structures	GLX DB-21	Active
GLX DB-21.5.11.8.1	Demolitions	GLX DB-21	Active
GLX DB-21.5.11.1	Roadway Bridges	GLX DB-21	Active
GLX DB-21.5.11.1.22	Broadway (Bridge No. S-17-013)	GLX DB-21	Active
GLX DB-21.5.11.1.1	Cedar St (Somerville) (Bridge No. S-17-012)	GLX DB-21	Active
GLX DB-21.5.11.1.3	Lowell St (Somerville) (Bridge No. S-17-011)	GLX DB-21	Active
GLX DB-21.5.11.9	Drainage	GLX DB-21	Active
GLX DB-21.5.11.5	Retaining & Noise Walls	GLX DB-21	Active
GLX DB-21.5.11.6	Stations	GLX DB-21	Active
GLX DB-21.5.11.6.1	Magoun Square	GLX DB-21	Active
GLX DB-21.5.11.6.16	Ball Square	GLX DB-21	Active
GLX DB-21.5.11.4	Track	GLX DB-21	Active
GLX DB-21.5.11.4.1	Commuter Track 1 (EB) (Sta. 200+00 - 151+20)	GLX DB-21	Active
GLX DB-21.5.11.4.2	Commuter Track 2 (WB) (Sta. 200+00 - 151+20)	GLX DB-21	Active
GLX DB-21.5.11.4.3	Medford Branch EB (Sta. 344+00 - 295+00)	GLX DB-21	Active
GLX DB-21.5.11.4.10	Medford Branch WB (Sta. 344+00 - 295+00)	GLX DB-21	Active
GLX DB-21.5.11.10	Community Path	GLX DB-21	Active
GLX DB-21.5.11.3	Systems	GLX DB-21	Active
GLX DB-21.5.11.3.2	OCS	GLX DB-21	Active
GLX DB-21.5.11.3.8	TPSS	GLX DB-21	Active
GLX DB-21.5.11.3.7	Communications	GLX DB-21	Active
GLX DB-21.5.11.3.6	Signaling	GLX DB-21	Active
GLX DB-21.5.18	Segment 3	GLX DB-21	Active
GLX DB-21.5.18.11	Utilities	GLX DB-21	Active
GLX DB-21.5.18.5	Earthwork, Clearing & Grubbing	GLX DB-21	Active
GLX DB-21.5.18.8	Structures	GLX DB-21	Active
GLX DB-21.5.18.8.1	Demolition	GLX DB-21	Active
GLX DB-21.5.18.14	Railroad Bridge	GLX DB-21	Active
GLX DB-21.5.18.14.1	Washington St Bridge	GLX DB-21	Active
GLX DB-21.5.18.9	Drainage	GLX DB-21	Active
GLX DB-21.5.18.7	Retaining & Noise Walls	GLX DB-21	Active
GLX DB-21.5.18.6	Track	GLX DB-21	Active
GLX DB-21.5.18.6.1	Commuter Track 1 (EB) (Sta. 151+20 - 87+70)	GLX DB-21	Active
GLX DB-21.5.18.6.2	Commuter Track 2 (WB) (Sta. 151+20 - 87+70)	GLX DB-21	Active
GLX DB-21.5.18.6.3	Medford Branch EB (Sta. 295+00 - 221.80)	GLX DB-21	Active
GLX DB-21.5.18.6.6	Medford Branch WB (Sta. 295+00 - 221.80)	GLX DB-21	Active
GLX DB-21.5.18.1	Stations	GLX DB-21	Active
GLX DB-21.5.18.1.2	Gilman Square	GLX DB-21	Active
GLX DB-21.5.18.1.1	East Somerville	GLX DB-21	Active
GLX DB-21.5.18.2	Roadway Bridges and Underpasses	GLX DB-21	Active
GLX DB-21.5.18.2.2	Medford St (Somerville) (Bridge No. S-17-007)	GLX DB-21	Active
GLX DB-21.5.18.2.3	School St (Somerville) (Bridge No. S-17-008)	GLX DB-21	Active
GLX DB-21.5.18.2.1	Walnut St (Somerville) (Bridge No. S-17-006)	GLX DB-21	Active
GLX DB-21.5.18.3	Community Path	GLX DB-21	Active
GLX DB-21.5.18.4	Pump Stations	GLX DB-21	Active
GLX DB-21.5.18.4.1	Washington St (B)	GLX DB-21	Active
GLX DB-21.5.18.4.5	Washington St (A)	GLX DB-21	Active
GLX DB-21.5.18.10	Systems	GLX DB-21	Active
GLX DB-21.5.18.10.3	OCS	GLX DB-21	Active
GLX DB-21.5.18.10.8	TPSS	GLX DB-21	Active
GLX DB-21.5.18.10.7	Communications	GLX DB-21	Active
GLX DB-21.5.18.10.6	Signaling	GLX DB-21	Active
GLX DB-21.5.19	Segment 4	GLX DB-21	Active
GLX DB-21.5.19.10	Utilities	GLX DB-21	Active
GLX DB-21.5.19.9	Earthwork, Clearing & Grubbing	GLX DB-21	Active
GLX DB-21.5.19.5	Drainage	GLX DB-21	Active
GLX DB-21.5.19.1	Station	GLX DB-21	Active
GLX DB-21.5.19.1.16	Lechmere Relocation	GLX DB-21	Active
GLX DB-21.5.19.7	Viaducts	GLX DB-21	Active
GLX DB-21.5.19.7.3	Lechmere (LEV)	GLX DB-21	Active
GLX DB-21.5.19.7.1	Medford (MBV)	GLX DB-21	Active
GLX DB-21.5.19.7.1.2	Medford Branch South	GLX DB-21	Active

WBS Code	WBS Name	Project ID	Project Status
GLX DB-21.5.19.7.1.3	Medford Branch North	GLX DB-21	Active
GLX DB-21.5.19.7.1.4	Medford Branch North-1	GLX DB-21	Active
GLX DB-21.5.19.2	Retaining & Noise Walls	GLX DB-21	Active
GLX DB-21.5.19.8	Pump Station	GLX DB-21	Active
GLX DB-21.5.19.8.9	Red Bridge	GLX DB-21	Active
GLX DB-21.5.19.4	Track	GLX DB-21	Active
GLX DB-21.5.19.4.3	Medford Branch EB (Sta. 221.80 - 177+90)	GLX DB-21	Active
GLX DB-21.5.19.4.1	Medford Branch WB (Sta. 221.80 - 177+90)	GLX DB-21	Active
GLX DB-21.5.19.3	Systems	GLX DB-21	Active
GLX DB-21.5.19.3.1	TPSS	GLX DB-21	Active
GLX DB-21.5.19.3.1.3	Traction Power Substation	GLX DB-21	Active
GLX DB-21.5.19.3.4	Communications	GLX DB-21	Active
GLX DB-21.5.19.3.3	Signaling	GLX DB-21	Active
GLX DB-21.5.19.3.5	OCS	GLX DB-21	Active
GLX DB-21.5.20	Segment 5 - VMF	GLX DB-21	Active
GLX DB-21.5.20.10	Utilities	GLX DB-21	Active
GLX DB-21.5.20.1	Structures & Yard Demolitions	GLX DB-21	Active
GLX DB-21.5.20.6	Clearing & Grubbing	GLX DB-21	Active
GLX DB-21.5.20.5	Drainage	GLX DB-21	Active
GLX DB-21.5.20.4	Retaining & Noise Walls	GLX DB-21	Active
GLX DB-21.5.20.2	Track	GLX DB-21	Active
GLX DB-21.5.20.2.3	Outside	GLX DB-21	Active
GLX DB-21.5.20.2.1	Inside	GLX DB-21	Active
GLX DB-21.5.20.9	Vehicle Maintenance Facility	GLX DB-21	Active
GLX DB-21.5.20.9.6	Transportation Office Building	GLX DB-21	Active
GLX DB-21.5.20.9.10	Vehicle Maintenance Building	GLX DB-21	Active
GLX DB-21.5.20.9.1	VMF Yard	GLX DB-21	Active
GLX DB-21.5.20.3	Systems	GLX DB-21	Active
GLX DB-21.5.20.3.6	Signaling	GLX DB-21	Active
GLX DB-21.5.20.3.2	OCS	GLX DB-21	Active
GLX DB-21.5.20.3.8	TPSS	GLX DB-21	Active
GLX DB-21.5.20.3.7	Communications	GLX DB-21	Active
GLX DB-21.5.20.3.4	Local Testing & Commissioning	GLX DB-21	Active
GLX DB-21.5.21	Segment 6 - Union Square	GLX DB-21	Active
GLX DB-21.5.21.9	Earthwork, Clearing & Grubbing	GLX DB-21	Active
GLX DB-21.5.21.5	Drainage	GLX DB-21	Active
GLX DB-21.5.21.10	Utilities	GLX DB-21	Active
GLX DB-21.5.21.4	Viaducts	GLX DB-21	Active
GLX DB-21.5.21.4.7	Union Square EB (UEV)	GLX DB-21	Active
GLX DB-21.5.21.4.1	Union Square WB (UWV)	GLX DB-21	Active
GLX DB-21.5.21.1	Station	GLX DB-21	Active
GLX DB-21.5.21.1.16	Union Square	GLX DB-21	Active
GLX DB-21.5.21.3	Retaining & Noise Walls	GLX DB-21	Active
GLX DB-21.5.21.2	Track	GLX DB-21	Active
GLX DB-21.5.21.2.1	Union Square WB (Sta. 39+33 - 1+15)	GLX DB-21	Active
GLX DB-21.5.21.2.3	Union Square EB (Sta. 45+90 - 0+95)	GLX DB-21	Active
GLX DB-21.5.21.6	Systems	GLX DB-21	Active
GLX DB-21.5.21.6.1	OCS	GLX DB-21	Active
GLX DB-21.5.21.6.3	Signaling	GLX DB-21	Active
GLX DB-21.5.21.6.6	TPSS	GLX DB-21	Active
GLX DB-21.5.21.6.4	Communications	GLX DB-21	Active
GLX DB-21.5.10	Roadway & Traffic Improvements	GLX DB-21	Active
GLX DB-21.5.10.1	Reconstruction	GLX DB-21	Active
GLX DB-21.5.10.2	Intersections	GLX DB-21	Active
GLX DB-21.8	Start-up / Testing / Commissioning	GLX DB-21	Active

APPENDIX 8

\$100 Million Cost Loading Example

APPENDIX 9

Cash Flow Projections

Green Line Extension Sample \$100 Million Cash Flow

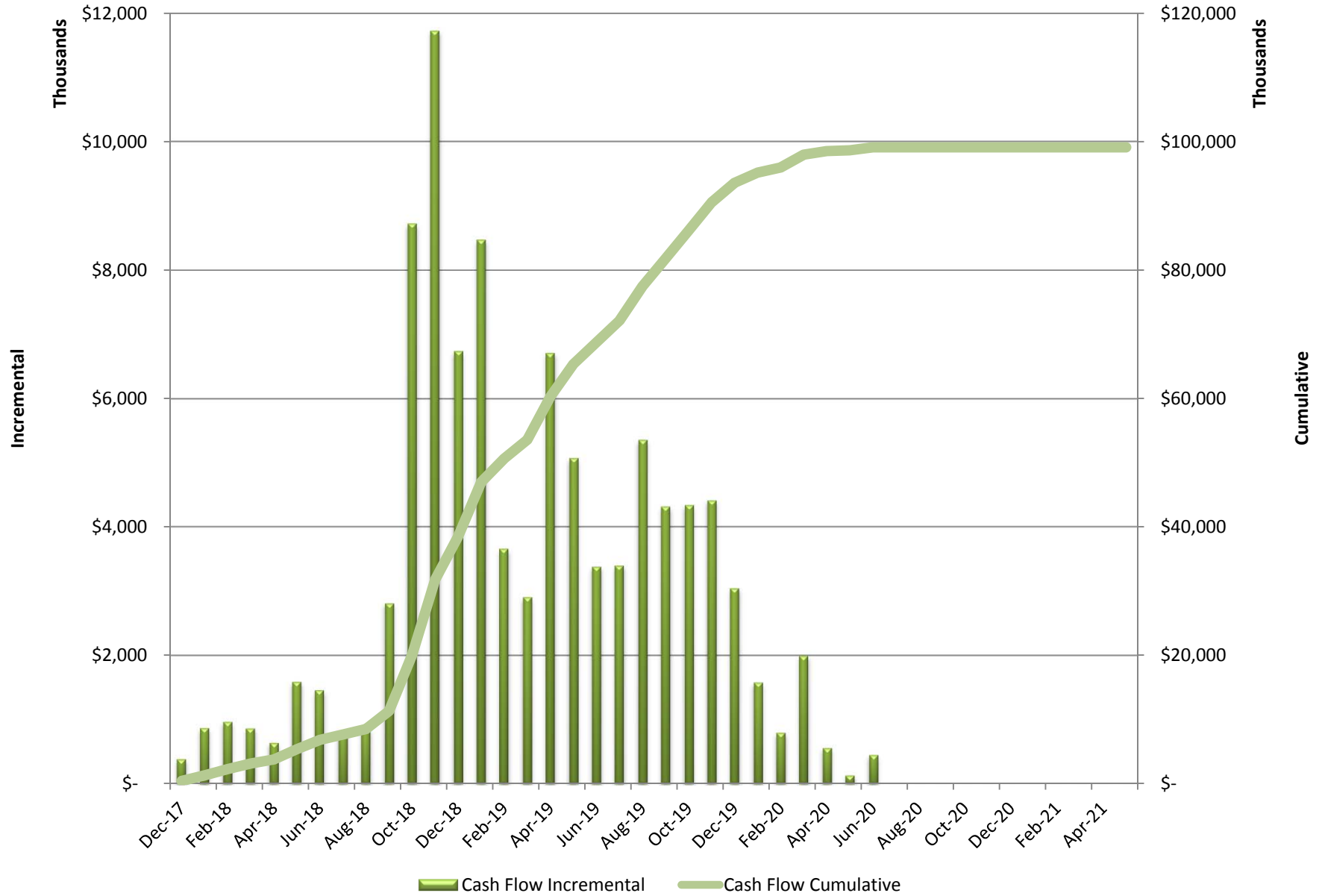



Response to the Request for Proposal
for the Green Line Extension Design Build Project

Submitted to
Massachusetts Department of Transportation and
The Massachusetts Bay Transportation Authority

Part 4 – Technical Solutions Qualitative Evaluation Criteria Information



TABLE OF CONTENTS



PART 4

- Section 4.1 Systems and System Integration
- Section 4.2 Elevated Guideway and Structures along the Guideway
- Section 4.3 Stations
- Section 4.4 Landscaping and Station Signage
- Section 4.5 Vehicle Maintenance Facility
- Section 4.6 Civil and Guideway
- Section 4.7 Drainage and Stormwater Management
- Section 4.8 Environmental Management Strategy
- Section 4.9 Utilities

4. TECHNICAL SOLUTIONS QUALITATIVE EVALUATION CRITERIA INFORMATION

4.1 SYSTEMS AND SYSTEMS INTEGRATION

GLX Constructors' approach to the Green Line's systems and systems integration is to customize and implement proven, reliable systems that are successful on other projects and compatible with the MBTA's existing infrastructure.

GLX Constructors' team members have delivered rail projects in dense urban environments, including active rail and integration with new and existing systems including the design of the MBTA's projects for more than 35 years. In addition to our Key Personnel, our team is strengthened by:

▶ **Tom O'Hara, Deputy Design Manager – Operations, Systems, and VMF.** Tom has worked with the MBTA for 24 years in the Engineering and Maintenance directorate giving him extensive knowledge of operational policies and procedures.

▶ **Benjamin Stell, Traction Power Lead.** Benjamin has more than 30 years of experience and is familiar with the MBTA's systems.

GLX Constructors' Systems Integration Team will have a central role through all phases of design, construction, commissioning, and rail activation to provide the MBTA with higher schedule and cost certainty.

4.1.A LIGHT RAIL TRANSIT SYSTEMS

Description of GLX Constructors' Design Methodology and Approach

Throughout the design process, GLX Constructors will use system engineering principles to make sure each of the systems' elements are incorporated into a single contiguous, compliant, and functional system. We will use the INCOSE (International Council on Systems Engineering) V-Model, demonstrated in Figure 4.1-1, as the basis for our system design.

System Engineering Management Plan. A System Engineering Management Plan (SEMP) is a management approach that makes sure our systems are

designed, integrated, installed, tested and properly operational across design disciplines and throughout the life of the Project. The SEMP focuses on defining customer needs and constraints, lay out the activities, resources, budget, timeline, and required functionality early in the development cycle.

The SEMP documents requirements, and proceeds with design synthesis and system validation while considering the complete issues a hand, including:

- ▶ Operations
- ▶ Performance
- ▶ Testing
- ▶ Manufacturing
- ▶ Cost & Schedule
- ▶ Training and Support
- ▶ Disposal

The scope of our SEMP describes the main systems engineering tasks and activities required during the program development stage to make certain the electrical, mechanical, and functional aspects, systems design, and interfaces are in accordance with the Contract Specifications.

Requirements Management Plan. GLX Constructors will institute the Design Requirements Management Plan (DRMP) at the beginning of the Project execution and will serve to identify the key requirements of the Technical Provisions. The DRMP accomplishes the following:

- ▶ Confirms which documents were reviewed
- ▶ Flags the requirements
- ▶ Properly assigns the requirements
- ▶ Confirms that the requirements were sufficiently satisfied

The Systems Integration Manager will manage the DRMP and complete the requirement while independent compliance personnel will validate the requirement. Figure 4.1-3 demonstrates GLX Constructors' review of these requirements during the proposal development phase.

“**Our design team is intimately familiar with the MBTA's transit, commuter, and system operations; Key Personnel and processes; overall function and operation; and how the MBTA services the local community and abroad. This knowledge will allow our team to mitigate issues before they arise.**”

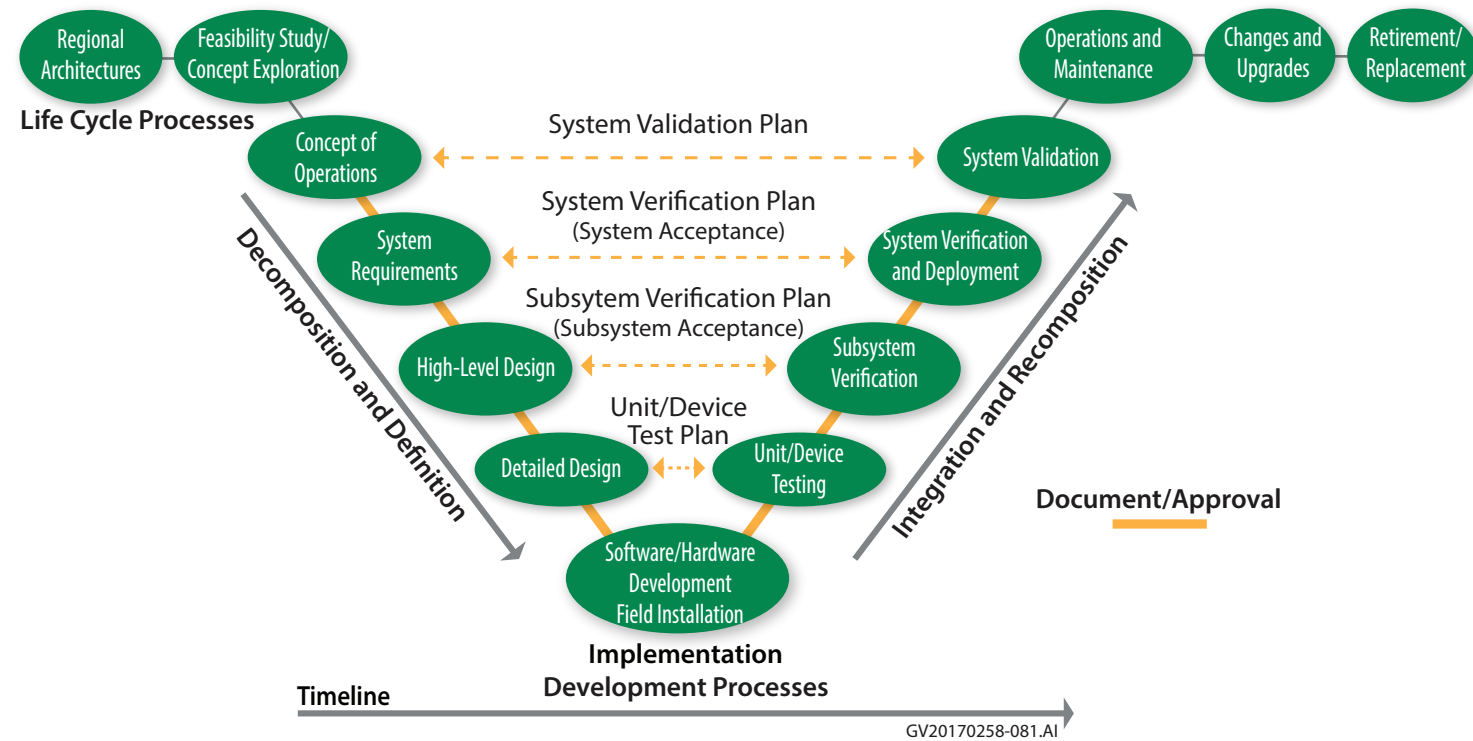

Figure 4.1-1. Systems Engineering Life-Cycle V-Model. GLX Constructors' Method to review, test, and commission the Project.

System Integration Management Plan. Our Systems Integration Management Plan (SIMP) will contribute to the Project's successful systems integration through the following approach:

- ▶ Implement a "team approach" to the systems integration process and manage the interfaces between parties, disciplines, consultants, and subconsultants.
- ▶ Assign Project-wide responsibility for interface management.
- ▶ Identify and document interfaces between components by developing, maintaining, and monitoring the interfaces through Interface Control Documents (ICDs) and a Systems Interface Matrix.
- ▶ Resolve interface requirement conflicts.
- ▶ Confirm that the components function as a whole and meet MBTA's design criteria and guidelines, and local Codes and Guidelines.
- ▶ Review interfaces at each design stage and change process.

Testing and Commissioning. Interface management involves controlling the various complex interfaces and requires the following steps shown in Figure 4.1-2 throughout the design and development of the Project.

Project processes are used to manage implement and test interfaces. We will generate an ICD to address and document each individual interfaces. The

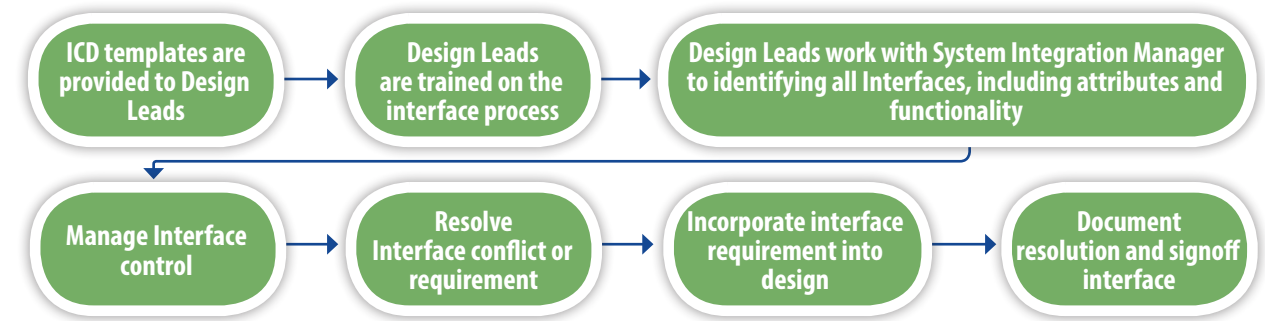

Figure 4.1-2. System Interface Management Process. Project processes are used to manage implement and test interfaces.

Interface Matrix, Figure 4.1-4, documents the interdependencies and ICDs, which govern interfaces between various Green Line sub-systems.

We have the following systems in place, per the MBTA's standard testing requirements:

- ▶ **Train Control/Signaling.** The train control and signaling system will be designed, installed, and locally tested from the control center. The testing and verification from the control center will utilize the SCADA system and will work in conjunction with the other systems.
- ▶ **Communications.** This includes all stations communication elements, such as the CCTV, PA, TEL, FA, and Intrusion.
- ▶ **Traction Power.** This includes the verification, position, and operation of the traction power disconnect switches, DC circuit breakers, transformers/rectifiers, and all other internals within the substations.

Figure 4.1-3. Requirements Traceability Matrix. During proposal development, GLX Constructors has thoroughly reviewed the design requirements and will manage the requirements using the Requirements Traceability Matrix.

► **Overhead Catenary.** The overhead catenary system will be tested, including the verification of all tensions, height and staggers at support and mid-span locations, smooth pantograph travel under the new overhead catenary systems, dynamic outline of the transit cars in conjunction with the overhead catenary system elements, hardware connection and torque, and sectionalizing (in conjunction with the traction power supply system).

Verification and Validation. Fixed facilities, systems, and equipment undergo tests throughout the construction and start-up phases of the Project. As the tests progress and portions of the system become operational, certain start-up tests are performed confirming completeness, operational readiness, and the reliability and safety of the system. Such tests required throughout the construction and start-up phases are:

- First Article Inspection
- Factory Acceptance Testing
- Inspection and Installation Verification Testing
- Site Acceptance Testing
- System Integration Testing
- Pre-Revenue Operations

Interface Control Forms	Interface B	Guideway	Trackwork	Stations	O&M Facility	MEP & Fire Protection	Roadway	Utilities	Light Rail Vehicle	Train Control	Traction Pwr Supply	Overhead Contact	Communications	Control and Monitor	Fire and Security	Traffic Signals/ITS	Fare Collection	Corrosion Ctrl & Grd	Other
		GDW	TRK	STN	OMF	FRP	TRF	UTL	LRV	TCS	TPS	OCS	COM	CMS	FSS	TRF	FAC	CCG	OTH
Interface A	GDW	▲	▲	▲	▲	▲	▲	▲	▲	▲	▲	▲	▲	▲	▲	▲	▲	▲	▲
Guideway	GDW	▲	▲	▲	▲	▲	▲	▲	▲	n/a	▲	▲	▲	▲	▲	▲	n/a	▲	▲
Trackwork	TRK	▲	▲	▲	n/a	▲	n/a	▲	▲	▲	▲	n/a	n/a	n/a	▲	n/a	▲	▲	▲
Stations	STN	▲	▲	▲	n/a	▲	▲	▲	▲	▲	▲	▲	▲	▲	▲	▲	▲	▲	▲
O&M Facility	OMF	▲	▲	▲	▲	▲	n/a	▲	▲	▲	▲	▲	▲	▲	▲	▲	n/a	▲	▲
MEP & Fire Protection	FRP	▲	▲	▲	▲	▲	n/a	▲	n/a	▲	n/a	▲	▲	▲	▲	n/a	n/a	n/a	▲
Roadway	RDW	▲	▲	▲	▲	▲	▲	n/a	n/a	n/a	▲	▲	▲	▲	▲	▲	n/a	n/a	▲
Utilities	UTL	▲	▲	▲	▲	▲	▲	▲	n/a	▲	▲	▲	▲	▲	▲	▲	▲	▲	▲
Light Rail Vehicle	LRV	▲	▲	▲	▲	▲	▲	▲	▲	▲	▲	▲	▲	▲	▲	n/a	n/a	n/a	n/a
Train Control	TCS	▲	▲	▲	▲	▲	▲	▲	▲	▲	▲	n/a	▲	▲	▲	▲	n/a	▲	▲
Traction Power Supply	TPS	▲	▲	▲	▲	▲	▲	▲	▲	▲	▲	▲	▲	▲	▲	n/a	n/a	▲	▲
Overhead Contact	OCS	▲	▲	▲	▲	▲	▲	▲	▲	▲	▲	▲	n/a	▲	n/a	▲	n/a	▲	▲
Communications	COM	▲	▲	▲	▲	▲	▲	▲	▲	▲	▲	▲	▲	▲	▲	▲	▲	▲	▲
Control and Monitor	CMS	▲	▲	▲	▲	▲	▲	▲	▲	▲	▲	▲	▲	▲	▲	▲	▲	▲	▲
Fire and Security	FSS	▲	▲	▲	▲	▲	▲	▲	▲	▲	▲	▲	▲	▲	▲	n/a	▲	▲	▲
Traffic Signal/ITS	TRF	▲	▲	▲	▲	▲	▲	▲	▲	▲	▲	▲	▲	▲	▲	▲	n/a	▲	▲
Fare Collection	FAC	▲	▲	▲	▲	▲	▲	▲	▲	▲	▲	▲	▲	▲	▲	▲	▲	▲	▲
Corrosion Ctrl & Grd	CCG	▲	▲	▲	▲	▲	▲	▲	▲	▲	▲	▲	▲	▲	▲	▲	▲	▲	▲
Other	OTH	▲	▲	▲	▲	▲	▲	▲	▲	▲	▲	▲	▲	▲	▲	▲	▲	▲	▲

Figure 4.1-4. Interface Matrix. Our Systems Integration Team will design an Interface Matrix to ensure all aspects of the project are managed.

The Safety and Security Certification Plan (SSCP) makes certain technical specifications and construction meets the established safety requirements by ensuring all safety-related tests are completed and that all identified hazards are resolved. The safety content of operating procedures and training materials are reviewed to confirm they meet the established safety requirements. We manage and coordinate the Safety and Security Certification Plan Program the Systems Integration Test Plan Program.

The Systems Integration Test Plan encompasses the Test Plan, Test Procedures, and Test Forms. Test procedures will be developed by the appropriate vendor as it relates to their scope of work and will be incorporated as part of the Systems Integration Test Plan.

The Operational Tests will be performed by Safety and Security and Rail Operations personnel with the support of GLX Constructors and any required sub-contractors, as defined in the test plans.

Identify Key Systems Suppliers and Overall Systems Integrator

GLX Constructors’ Lead Designer, STV, holds the role of systems integrator, and will make certain each of the systems successfully function individually and together. Our team has extensive experience with all of the key system suppliers as shown in Figure 4.1-5.

Key Systems Suppliers	Evidence of Previous Experience
Alstom Signaling	Alstom recently purchased General Electric Transportation Systems (GETS), whom GLX Constructors’ team member, Balfour Beatty, successfully worked with on the MBTA Greenbush Commuter Rail Line Project.
Ansaldo STS (formerly Union Switch and Signal)	Ansaldo is a national and international provider of train control/signaling systems, engineering, and products and regularly works with the MBTA. GLX Constructors’ team member, Balfour Beatty, has a previous working relationship with Ansaldo on the SEPTA Broad Street Subway Signal Upgrade Project.
Xo-Rail (Wabtec)	Xo-Rail is a nationally and internationally successful designer/provider of train control and communications systems. GLX Constructors’ team members, Fluor and Balfour Beatty, are currently working with on the Eagle P3 Commuter Rail Project in Denver, CO.
Diverging Approaches Incorporated (DVI)	DVI has successfully performed/delivered transit/commuter rail projects across the country, performing engineering, procurement, systems installations supervision, testing, and final cutover oversight.

Figure 4.1-5. GLX Constructors’ Experience with Key Systems Suppliers. GLX Constructors will bring well-recognized suppliers with relevant systems integration experience to the Project.

4.1.B TRAIN CONTROL SYSTEM DESIGN

Signaling and Train Control System Narrative

The Signaling and Train Control System (S&TCS) will comply with all the requirements specified in both the Technical Provisions and Specification by tracing the design back to a Requirement Traceability Matrix (RTM). The RTM

will be utilized to develop the Contract Deliverable Requirements List (CDRL) at the onset of the Project which will include all design submittals, document submittals, product submittals, as-builts, reports, and studies. The RTM will generate the ICDs that will support the holistic design approach to the Green Line Extension. The design of the S&TCS will go through multiple design checks throughout the life cycle of the project. This includes the QA/QC process, Intra and Inter-discipline reviews, and over-the-shoulder reviews with the client prior to each deliverable to ensure that all requirements are encapsulated.

S&TCS Architecture. The S&TCS for the Project will extend the existing signal system from its current terminus point at Lechmere Station to the new terminal stations at both College Avenue on the Medford Branch Line and Union Square on the Union Square Branch. The S&TCS will be functionally compatible with the existing MBTA Green Line utilizing a wayside Automatic Block Signal (ABS) system without absolute stop enforcement. The new system will tie into the existing system through a 96-strand fiber optic cable dedicated to the signal system. The new fiber cable will interface both the non-vital microprocessor and the vital microprocessor located within the new Lechmere Central Instrument House (CIH) with the existing Science Park CIH. The signal design technology between the existing system and the new will not change drastically. Vital relays will be greatly reduced with the implementation of microprocessors and lamp driver circuitry. The majority of the external line wire cables will be eliminated when the fiber optic cables are installed.

The S&TCS major wayside equipment designed for the extension will consist of:

ABS block signaling system for movement authority and safe train separation. Automatic wayside signals will be installed along the alignment between interlocking to support the required headway and run time requirements. Color light signals that are either wall mounted or mast mounted. Each signal layout will be provided with appropriately colored LED lens units. Pedestal mounted signal layouts will include a foundation, split-base junction box, mast, and ladder. The number of aspects range from two to five, depending upon the design requirements.

We will use double rail on the main line and single rail in crossovers and turnout.

The track circuit detection system will be immune to the 600-volt traction power system and provide broken rail detection. The insulated joint connections will allow the traction power return current to flow around the insulated joint.

Dual-control power switch machines and layouts will use vital relay control, overload, and point indication.

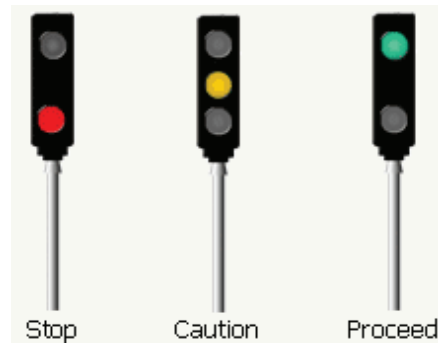

Wayside Signal. Each signal layout will be provided with appropriately colored LED lens units.



Impedance Bond (IB). The following is an example of an IB which may be used on the Project.

We will install the following wayside equipment along the ROW:

- ▶ Hand throw switch machines with an electric lock.
- ▶ Snowmelter heating system.
- ▶ Automatic Vehicle Identification (AVI) systems, that is compatible with the existing on board systems. The AVI System will be used as the primary routing of trains through the interlocking.
- ▶ Wayside pushbuttons at route request locations.
- ▶ Prewired Central Instrument Houses (CIH).
- ▶ Prewired wayside junction boxes.

Description of the Interaction of the S&TCS. The integration between the different systems will provide a holistic design concept to minimize any complications that occur during the design process. Coordination between Track, OCS, Traction Power, and communication subsystems is critical. The design requirements of the train control detection system are critical to provide a safe and reliable system. The light rail vehicle also plays an important role in the signal system design from the block design, track circuit shunting sensitivities, power requirements, and negative returns paths, to the placement of wayside equipment outside of the clearance envelope.

The S&TCS will be designed, installed, and tested, so the interface between the vehicles and the signal system provides a safe and reliable system. This is accomplished by:

- ▶ Providing interface documents, so all requirements are identified and addressed.
- ▶ Providing state-of-the-art equipment that meet or exceed the requirements as identified in the Project documents.
- ▶ Ensuring that the train detection system is able to detect the shunting sensitivity of the LRV.
- ▶ Providing optimum viewing of the wayside signals to the train operator and, if necessary, adding repeater signals.
- ▶ Interfacing the wayside AVI subsystem with the LRV carborne equipment to make certain the AVI message is transmitted and received.
- ▶ Providing interlocking signals to indicate the status of the interlocking and route alignment.

The interface between the signal system and the track design will be coordinated to clearly identify the limits of VMF yard control functions.



Switch Machine. The following is an example which may be used on the Project.

“Our designs make certain no single point failure of a component or subsystem (including dependent failure(s)) will cause an unsafe condition.”

This will indicate the LRVs are “clear” of the revenue service on the Branch lines. Both the Union Square Branch and the Medford Branch Yard leads will support LRVs operating in either direction; this will be accomplished by locating either wayside pushbuttons and/or AVI loops on the Yard leads to allow for trains entering or exiting revenue service.

Description of the S&TCS Proposed Fall Back Operation. Green Line Operators are required to contact the Operations Control Center Light Rail Dispatcher should they encounter a signal holding red after one minute or is improperly displayed. They may not proceed by the signal unless directed to do so by the Dispatcher or an authorized official – traveling at restricted speed until the clearing signal for that block, watching for switch unaligned, another vehicle, broken rail, or other obstruction. Upon motivation of a signal malfunction, a Signal Maintainer is immediately dispatched to the area. Signals malfunctioning and holding red, or signal failures, result in the institution of a manual block in the affected area. A manual block requires that authorized personnel are placed in the affected area, and serve to clear Green Line trains in the affected area.

The signal system operation on the extension will be designed to support three different modes of operational control:

- ▶ Remote from the office
- ▶ Local from the CIH
- ▶ Field automatic from the AVI system

Under normal operations, the signal system will automatically run in field via the AVI system. Pushbutton will be installed to support the AVI system in the case of failure. Remote operations will be utilized for any route that is not supported by the AVI system. Local control operation can be utilized under emergency or maintenance situations.

The design of the Project will ensure that there will be a flawless transition between the existing signal system and the new S&TCS. The new signal system will support all operational requirements, such as headway and run time durations, as specified in the Technical Provisions Section 1.3.1.

Description of the S&TCS Yard Control Strategy and Interface. The strategy for vehicle movement in the Yard and Rail Maintenance Facility will include the use of “yard maps”, video monitoring and the installation of clearance markers. Direction from Authorized personnel in accordance with operating rules will dictate all movement within the Yard and Maintenance facility area. A requirement for movement into or out of a maintenance facility requires the assignment of personnel to watch the vehicle move through the bay door area. Other safeguards include the restriction of speed within maintenance facilities to no greater than three (3) miles per hour. All yard and repair facility moves require Operators to be observant of switch position, obstructions on the track and overhead catenary condition.

The VMF yard will be a non-vital yard with no signaling system interaction except when entering and leaving the yard. To prevent the possibility of a runaway rail vehicle from entering the mainline or fouling adjacent tracks, a hand-thrown sliding block derails will be installed on yard leads. Coordination between the MBTA Operations and the Signals and Communication Group will be required to ensure all requirements are addressed.

Description of S&TCS Integration with the Vehicle

We will implement the systems integration process by using a systematic approach to managing system components and interfaces. At the start of the Project, we will hold a meeting with the MBTA Railroad Operations team to review current, applicable MBTA standards and our design approach. This will result in alignment of ICDs so that all requirements are addressed.

To ensure full compatibility of all signal system requirements, we will coordinate all relevant signal system activities, with special attention given to electromagnetic interference (EMI) and signal system compatibility. GLX Constructors will review and evaluate the MBTA’s Specifications for all proposed signal equipment to make certain the provided equipment meets the intent of these specifications.

Past Experience. GLX Constructors has extensive experience in relay and microprocessor based designs of interlocking control, ABS and cab signaling systems, block design and block design analysis, highway crossing design with interface to traffic control systems, vehicle and communication systems interface, staging, planning, and construction management services for new train control systems and modifications to existing systems.

In addition to design experience in transit and railroad train control design, GLX Constructors’ key team members have experience in installing, testing, and commissioning transit train control systems, including the existing MBTA Green Line, Orange Line, and Red Line segments.

Within the past years, we have provided systems-related services for the MBTA, St. Louis Metro, Charlotte Area Transportation System (CATS), Chicago Metra, Long Island Railroad (LIRR), Metro-North Railroad (MNR) Los Angeles MTA (LACMTA) Baltimore MTA, and Portland Tri-Met.

Lessons Learned. Our most significant lessons learned from our past experience is the use of excellent communication. At the Project start, we will comprehensively develop a Systems Integration Management Plan. A properly conceived, managed, and executed Systems Integration Management Plan significantly reduces the potential for schedule impacts, workarounds, and other surprises by making certain that each new system design is properly integrated.

A critical element that will support the reliability and uptime of the communication systems will be the uninterruptible power supply (UPS). All

communication network elements will be supported by the UPS. The UPS will supply battery backup power to communication room equipment including remote and local switches and be sized to support the actual full load for a minimum of 8 hours. Local AC power will serve as the incoming source for the UPS battery.

4.1.C COMMUNICATION SYSTEMS DESIGN

Overall Systems Topology/Systems Connection Diagram

Figure 4.1-6 depicts the typical subsystem interfaces located throughout the Project as it relates to the Communications System. By using internet protocol (IP) devices, the design is able to extensively use network switches and routers to integrate a variety of subsystems.

A key interface is the public address system with the variable message signs. These two subsystems supplement each other by providing audio and visual messages to station passengers. Additional key interfaces are the closed circuit television (CCTV) system with the transit passenger information system and the access control system. Included in the list of key interfaces is the physical interface of the fiber optic backbone. This component is critical to providing all other means of various subsystems to communicate with each other.

The main success of the fiber optic backbone is tying it into the existing fiber infrastructure located at Science Park Station. Secondly, to ensure successful implementation of the fiber optic backbone throughout the extension, we will coordinate with the MBTA to ensure end-to-end connectivity. The fiber optic backbone provides direct interface between the subsystem and the end user for SCADA, Automatic Fare Collection, and other communications systems.

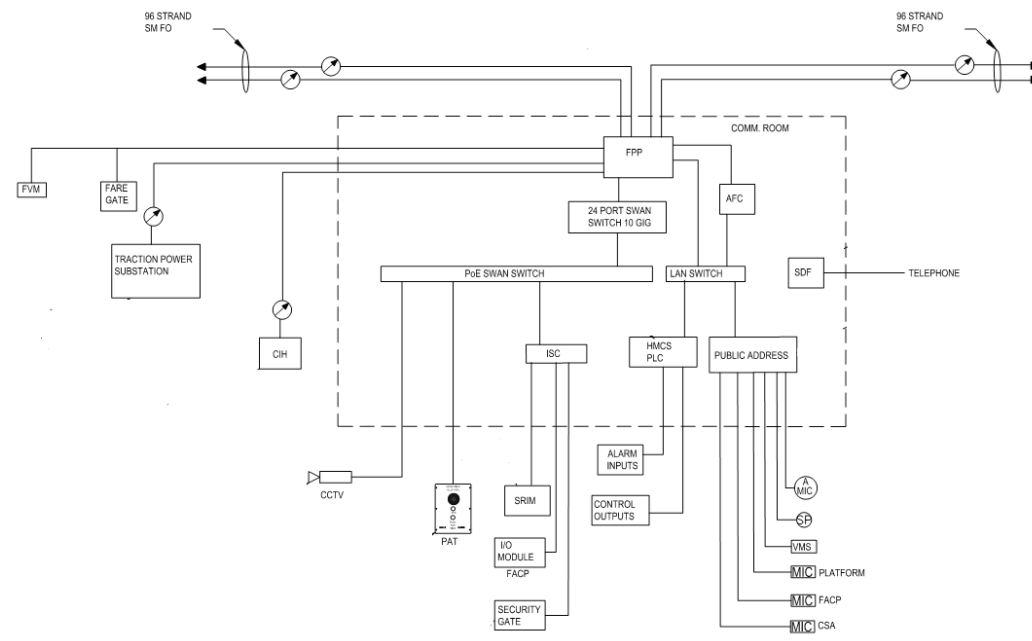

Figure 4.1-6. Communication Block Diagram.

Description of Communications System Design and Functionality

The MBTA's **fiber optic system** for the Project will tie into the existing fiber optic backbone at Science Park Station. The MBTA's existing fiber optic backbone, along the ROW, consists of two 96-strand cables. One 96-strand is currently dedicated to Communications system while the other is dedicated to Signal systems. The existing fiber optic cables are located in the existing trough on the viaduct. The Project will extend the infrastructure and fiber optic cables to new subsequent stations and wayside facilities within the scope of the Project. Various subsystems will utilize the fiber optic backbone to communicate throughout the MBTA system including but not limited to the **Public Address (PA) and Transit Passenger Information System (TPIS), Closed Circuit Television (CCTV), Supervisory Control and Data Acquisition (SCADA) with Hub Monitoring and Control System (HMCS), Access Control System (ACS), and Fare Vending Machines**. Each passenger station and wayside facility will have one or more of the aforementioned communication subsystems furnished and installed. In addition to interfacing with the fiber optic backbone, many of the communication subsystems will have interface with each other. CCTV will interface with ACS and the Passenger Assistance Telephone (PAT), PA will interface with TPIS and more. Many of the subsystem interfaces will be done via network layering via the sites network switch and router. Some interfaces, for the purposes of performance or safety, will be hardwired connection.

The station PA system will provide coverage throughout the passenger station covering the platform and mezzanine areas. The new PA system will integrate and interface with the existing Rockwell Collins (formerly ARINC) public address and variable message signs (VMS) headend hardware and software located at the operations control center (OCC). The new PA system will consist of loud speakers, microphones, digital signal processors, power amplifiers, and station control units. The system will provide an even audio output sound level throughout the station. The public address system integrate and interface with respect station's VMS. The VMS will be a light emitting diode (LED) scrolling sign that provide image. The integration and interface between the VMS and the PA system will provide the functionality to display text corresponding to the public address announcements. VMS units will all generate arrival messages. VMS units will be located on the station platforms and mezzanine.

The closed circuit television (CCTV) will provide real time internet protocol (IP) based video coverage at the passenger stations and yard. The CCTV will be a conduit to monitor, verify, and manage operations and incidents from the MBTA's OCC. The CCTV will utilizes Power over Ethernet (PoE) cameras that will view and cover public segments of the paid station areas, elevators, bike storage locations, access controlled doors, and pedestrian track crossings. The CCTV system will utilize camera, video servers, video recorders and local/wide area network to view, transmit and store digital video streams. The CCTV system will be compatible with MBTA's existing video management system. The

“
Our Train Control System personnel have railroad system engineering backgrounds with over 150 years of combined signals and train control design and field experience.”

CCTV system will integrate with the station's passenger assistance/information telephone (PAT) and elevator assistance telephone system.

Both the passenger and elevator telephone system will be **Voice over Internet Protocol (VoIP)** and be compatible with the existing PAT server located at the MBTA's customer call center. The PAT will provide two way voice communication at the passenger stations. PATs will be located at station fare collection area, platforms, and customer service areas. PATs and elevator assistance telephones will be viewable by the CCTV systems. A separate telephone network will be provided using the public switched telephone network (Verizon Centrex). Avaya VoIP telephones will be provided in accordance to the MBTA requirements. These phones will be compatible with the Avaya G450 gateway, PoE, and be mountable. The Avaya telephone will utilize category 6 (CAT-6) cabling infrastructure as it means of transmitting and receiving calls.

The access control system (ACS) portion of the project will be used to secure areas, facilities, rooms, and vehicle parking facilities. The ACS will consist of proximity card readers, electric door strike, magnetic door contacts, infrared request to exit, intelligent door controllers, and system controllers. All components of the ACS will interface and be controlled by the existing MBTA Lenel OnGuard system. Therefore, all ACS devices will be compatible with the existing MBTA Lenel OnGuard system. The ACS doors will be viewable by the CCTV system. The ACS will utilize the security wide area network to provide monitoring and control of system back to OCC.

Fare system interface will provide fiber optic cable connection to the array of fare vending machines located in the passenger stations. Each AFC room will provide cable management and an AFC switch. The AFC room will interface with the wide area network by way of Communications room switch via fiber optic cable. Fare vending machine installations will be based on MBTA requirements.

The Supervisory Control and Data Acquisition (SCADA) with Hub Monitoring and Control System (HMCS) will be provided as mean of automatically and manually monitoring an array of systems and subsystems within the MBTA infrastructure. The system will be wired with all necessary auxiliaries, and PLC programming software. The system will be fully integrated via software and hardware elements into the existing 45 High Street communications pre-processors, this includes integration of modules, points, and devices. SCADA/HMCS will be provided at stations and traction power substations. SCADA/HMCS subsystem interface includes HVAC, electrical, fire alarm, and plumbing systems.

A critical element that will support the reliability and uptime of the communication systems will be the uninterruptible power supply (UPS). All communication network elements shall be supported by the UPS. The UPS shall supply battery backup power to communication room equipment including remote and local switches. The UPS shall be sized to support the actual full load for a minimum of 8 hours. Local AC power shall serve as the incoming source for the UPS battery.

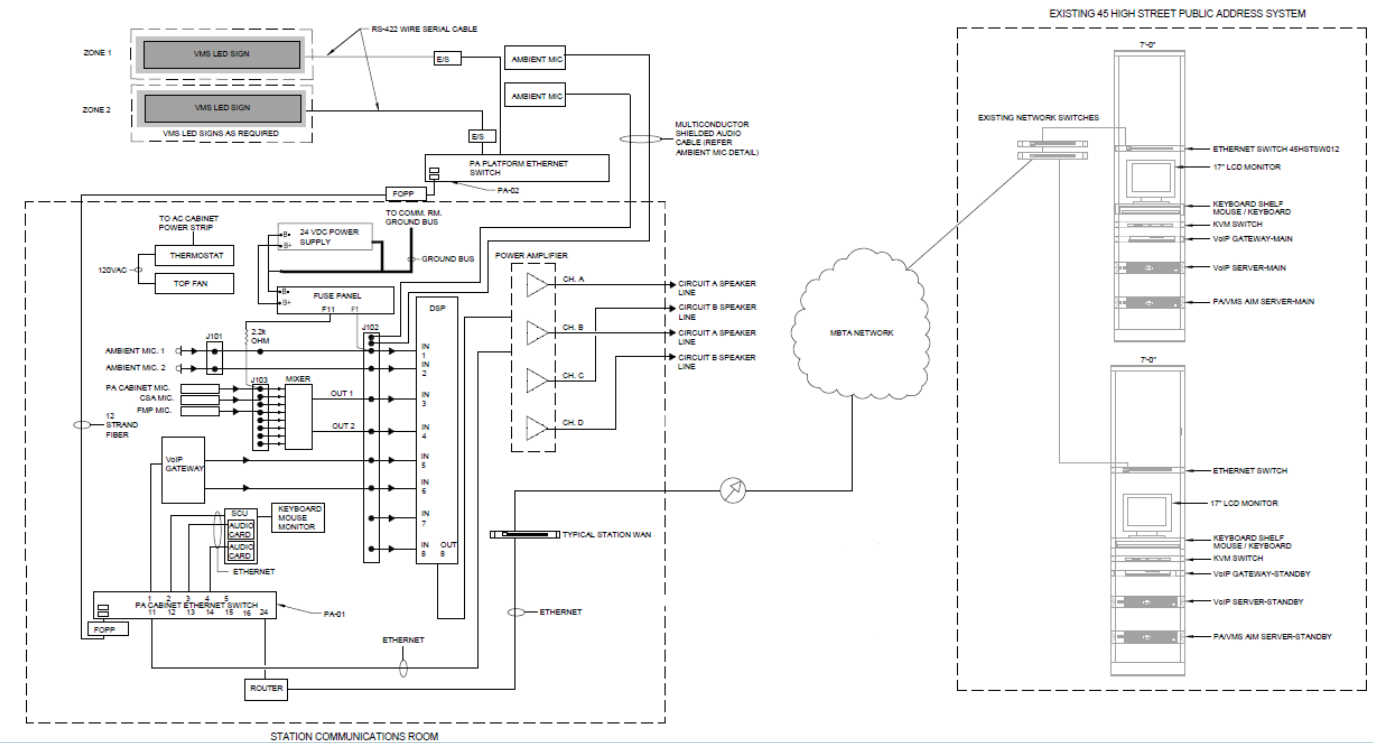

Figure 4.1-7. Project-specific Public Address Block Diagram.

Methods of Providing an Open-Data Link

Figure 4.1-7 demonstrates our approach to providing an open-data link to provide information on vehicle and systems scheduling and announcements.

Description of How the Proposed Communications Systems will Interface with Existing Communication Systems

We will closely coordinate with the MBTA in establishing a deep understanding of the MBTA's existing fiber optic infrastructure. We will identify all physical infrastructure communication ties needed to have a complete system interface as required by the project. GLX Constructors will evaluate existing infrastructure data to coordinate establishing an extension of the wide area network for the communication and signal systems. Integration of new infrastructure will be structured not to impede on existing Green Line operations. Test plans and procedures will provide for the various subsystems to be tested and commissioned. Performance and compliance testing will be conducted for each station and wayside facility subsystems to verify and confirm proper interface and integration between subsystems. Additional testing will confirm proper interface and integration to and between the various remote locations.

4.1.D TRACK WORK SYSTEM DESIGN

We have experience on many large system-intensive railroad projects in narrow corridors similar to the Project. The limited ROW on these constricted corridors requires close coordination between the track and system designers to verify

“ Our crosschecks go beyond determining that the footprint of the equipment remains in the ROW; the vehicle clearance envelope needs to be checked, safety walkways around the bungalow or cantilever need to be verified, and grading and drainage need to be provided.

See the MBTA standards and the track plans for details, including MBTA Special Trackwork Standard Drawings:

- ▶ Drawing #2000 – Standard Turnouts General layout
- ▶ Drawing #2002 – Standard Crossovers General layout
- ▶ Drawing #615 – Trackwork Plan for 150' C.R. Turnout
- ▶ Drawing #510 – Arema Modified No. 6 Turnout
- ▶ Drawing #2082 – No. 8 Welded Turnout Tie & Rail Layout
- ▶ Drawing #2102 – No. 10 Welded Turnout Tie & Rail Layout

Special Track Work Drawings

Special Track Work Geometry, Guardrails, and Restraining Rails. We will follow the Commuter Rail Design Standards Manual and the Technical Provisions to use guardrails at strategic locations and restraining rails on track curves.

The MBTA's Commuter Rail Design Standards Manual (CRDSM) Chapter 4, Part N requires resilient guardrails for the New Hampshire Commuter Line on bridges and hazardous locations like next to high voltage structures. The only bridge that will need guard rail is the Washington Street Bridge and the only Traction Power Substation adjacent to the New Hampshire Commuter Line is Gilman. We will provide guardrail at these locations.

Technical Provision Section 10.2.3.3 (e) requires Guardrail for the Light Rail trackwork to be used at certain locations such as bridges, stations, abutments, etc. Technical Provision Section 10.2.3.3 (d) requires Restraining Rail for the Light Rail trackwork to be used on the inside rails in curves from 100' to 1,000' radius. Curves of less than 100' will have restraining rail on both rails. For details, see MBTA Standards BSTP Drawing No. 900 Bridge Guard Installation Details and Drawing No. 905 Resiliently Fastened Bridge Guard Rail.

For GLX Constructors' Track Geometry details, see Section 4.6 Track Plans.

Proposed Track Structure/Rail Fastening Systems. GLX Constructors will follow the MBTA Commuter Rail Design Standards Manual (CRDSM) and the Technical Provisions in regards to Rail Fastening Systems. The MBTA Commuter Rail Design Standards Manual (CRDSM) Chapter 4, Part J requires resilient fasteners for any new trackwork on the New Hampshire Commuter Line. Technical Provision Section 10.2.3.3 (c) requires a fastening system for the Light Rail trackwork which will electrically isolate the rail from the tie and the ballast. See the MBTA Railroad Operations "Commuter Rail Material Specification No. 9269" and "Resilient fasteners Material Specification No. 9245".

Signals and Communications Infrastructure. See Drawing SYS-007.

4.1.E TRACTION POWER SYSTEM DESIGN

Traction Power Supply Design Process, Software Tools and Prior Evaluation of Load Flow Modeling, and Service Plan Proposed and Description of the Traction Power Supply Design, Failure Modes, and Mitigations

The proposed traction power system design is based on Section 11.1 of the Technical Provisions and supported by Redefinition Task drawings. Our technical and design approach are detailed below.

Utility Power Supply System. The proposed power supply system configuration reflects the modified MBTA 13.8 kV traction power system "spider diagram" that was included with the Redefinition Task drawings and described in the final Volume 2 Technical Provisions. Eversource will provide two independent, redundant underground 13.8 kV supply circuits to the Red Bridge Traction Power Substation (TPSS), and two independent, redundant underground 13.8 kV supply circuits to the Pearl Street TPSS. Two redundant aerial 13.8 kV circuits will be constructed between Pearl Street TPSS and Ball Square TPSS (circuits 0-54-1/RF1 and 0-54-2/RF2, installed on opposite sides of the ROW). If any one of these 13.8 kV supply circuit segments should trip off-line due to an electrical failure or construction accident, the remaining circuits will be capable of sustaining peak operational load indefinitely.

Traction Power Substations. New traction substations will be located at Ball Square, Pearl Street, and Red Bridge. These will be typical, MBTA double-ended (fully redundant) traction power substations equipped with the equipment specified in the Technical Provisions, including: dual 13.8 kV buses; dual 3 MW rectifier-transformer units; bus duct interconnections to rectifiers, 800 V class dc switchgear, and negative drainage board; dc disconnect switches for each dc circuit breaker; station battery system; 15 kV local control and instrument panel; SCADA and substation automation systems (SAS); and technical support equipment including 13.8 kV ground and test devices.

Ball Square and Pearl Street TPSS will each have six dc feeder breakers including two spares, and Red Bridge TPSS will have fourteen dc feeder breakers including three spares. The substations will be site-constructed, with floor plans and equipment arrangements similar to the Redefinition Task drawings, reflecting the equipment clearances as specified in Technical Provision Section 11.1.

The double-ended configuration of these substations mitigates the potential outage of any single piece of equipment due to electrical failure, accident, or maintenance. The substation is designed to operate indefinitely at peak operational load with any single piece of equipment out of service (a single contingency outage condition). Spare 13.8 kV and 600 Vdc circuit breakers will be provided for future or emergency (replacement) usage.

DC Power Distribution System. The dc power distribution system will be sectionalized and configured in accordance with the Redefinition Task drawings and as specified in the Technical Provisions. Power sections 14E, 14W, 13E and 13W will be supplied from Ball Square TPSS. Pearl St. TPSS will be connected to power sections 13E, 13W, 12E and 12W. Red Bridge TPSS will be connected to new power sections 12E, 12W, 11E, and 11W. Existing power section S-8 from Science Park Station to the extension interface will be divided into inbound and outbound power sections 8E and 8W. The outbound end of power sections 8E and 8W will be connected to Red Bridge TPSS, and the inbound end will be supplied by existing cables from North Station TPSS.

Within each TPSS, two 2,000 kcmil cables will be provided between each dc feeder breaker and each TPSS dc feeder disconnect switch. Two 1,000 kcmil cables will be installed between each TPSS dc feeder disconnect switch and each trackside disconnect switch for interface with the OCS. Two 1,000 kcmil aerial supplemental cables will be connected in parallel with the main line OCS for each track and tapped to the OCS as specified in the Technical Provisions.

Normally-open OCS tie switches (TPSS bypass switches) will be provided trackside at the interfaces between adjacent power sections. These switches can be closed to mitigate the outage of a dc feeder circuit resulting from electrical failure, accident, or maintenance.

DC Negative Return System. Ball Square and Pearl St. TPSS will each have four 2,000 kcmil negative return cables installed between the negative drainage board in each substation and the nearest cross-bonded track impedance bond. Red Bridge TPSS will have ten 2,000 kcmil negative return cables; these will be connected to the Medford and Union Square branch track impedance bonds, and to the VMF shop and yard tracks. Sufficient cables are provided to mitigate the outage of any negative return cable due to electrical failure, accident, or maintenance. The running rails for each main line track pair will be supplemented by a common 2,000 kcmil negative return cable that will be installed in the ballast, and connected to track cross bonds.

VMF Shop and Yard Traction Power System. The VMF shop and storage yard OCS will be powered from dc feeder breakers located in the Red Bridge TPSS. One of these feeders will be dedicated to the VMF shop OCS and auxiliary/stinger power switchgear that will provide power to two shop tracks. Normally open disconnect switches in the yard area will mitigate the potential outage of a feeder cable circuit due to electrical failure, accident or maintenance.

Unit Substations. Each of the three traction power substations will be equipped with a double-ended unit substation powered by a feeder from each 13.8 kV TPSS bus as specified in the Technical Provisions. The redundant 13.8 kV supply circuit and associated step-down transformer will mitigate the outage the supply equipment that could result from electrical failure, accident or maintenance. Dual-source substations will also be provided at each passenger

station. Each passenger station substation will obtain power from an Eversource 13.8 kV feeder, and one backup feeder from the nearest TPSS. An automatic transfer switch (ATS) connected to these two 13.8 kV sources will automatically switch between them when needed.

Software Tools and Prior Evaluation of Load Flow Modeling. GLX Constructors will conduct a comprehensive load flow simulation study to confirm that the proposed design will perform satisfactorily under the normal operational conditions and single contingency outages described the Technical Provisions. These operational conditions include three-car trains composed of AW3-loaded Breda Type 8 vehicles operating at five minute headways on each branch, and 2.5 minute headways on the shared portion of the extension. The study results will be communicated to MassDOT in a format similar to the December 30, 2016 DC Traction Power Loadflow Report prepared by the AECOM/HNTB Joint Venture that was provided with the GLX RFP. The system and vehicle information contained in the appendices to the December 30, 2016 load flow report will be referenced to build the load flow model, augmented as required by approved system design updates.

GLX Constructors will utilize the latest version of the Electric Traction System Analyzer (ETSA) for the load flow simulation study. An older version of the ETSA software was used by the AECOM/HNTB JV to perform the load flow simulations on which the current Project is based. The author of the ETSA software suite currently works for our Lead Designer. The baseline 3-car operation case from the December 30, 2016 load flow report will be modeled as a first step to compare results and confirm the validity of the load flow model. After the model has been confirmed, the single contingency outage scenarios will be simulated.

Conceptual Traction Power System Single Line Diagram

See Drawing SYS-004 and SYS-005.

4.1.F OVERHEAD CONTACT SYSTEM DESIGN AND TECHNICAL DETAILS

A successful OCS system design is distinguished by safety, high quality, high reliability, and ease of installation and maintenance. Our team will provide these attributes to lower life cycle cost on the Green Line system through unique interdisciplinary knowledge, experience, and proven processes. A contract documents requirements list will include pertinent industry standards and lessons learned from our experience. This list serves as an audit document for the QMP and will be heavily referenced during design and system validation so that our system will be safe and reliable for the MBTA and the public.

Description of the Overall Approach and Technical Details of the OCS

Design requirement documents prepared during the preliminary design stage are the cornerstone to the OCS design. Design requirements will incorporate fundamental properties, such as the MBTA's operating and maintenance plans,

installation and maintenance tolerances, and local climatic, geological, or environmental conditions. We have included functional characteristics such as conductor particulars, pantograph security, half-tension length limits, and structure spacing into the design requirements, creating an improved system.

GLX Constructors will be involved during all stages of the design, installation, and validation to provide cross discipline experience, feedback, and constructability reviews. This increases the speed of design and review while reducing the probability of design changes during construction.

Conductor Typical. The proposed design will utilize the conductors currently in use in the MBTA system so they may be interchanged with the existing MBTA network. The mainline alignment will be typical catenary construction utilizing balance weight assemblies to auto-tension 4/0 messenger and trolley wires over mainline and crossover tracks. Overlaps will be arranged throughout the alignment to best utilize the 3,000 feet maximum length and placed in tangent track where available to improve clearances. Supplemental feeders will be provided, when necessary, aurally at pole top and tensioned to reduce wind blow-off and maintain safe clearances between other wires, structures, and the public. Supporting the equipment aurally reduces the quantity of disconnect switches and the overall maintenance effort.

The train storage yard alignment will be semi-compensated single 4/0 trolley wire utilizing spring tensioners for all tracks (see example in Figure 4.1-9). The spring nominal tension will be set with coordination with the manufacturer to allow for the least sag at high temperatures while still maintaining the low temperature tension within safe criteria. Tension sections will be arranged around the yard to minimize the difference between the two trolley wires distance to fixed end from the track crossing or overlap point. This will reduce the variation in tension of the two crossing wires allowing for similar sag to reduce pantograph entanglement and maintenance efforts adjusting tensions at high or low temperatures.

Equipment Strategy. GLX Constructors plan to use products matching those mentioned in the Technical Provisions as well as those presently in-service on the MBTA system which have maintained positive performance records. By using well rated, compatible equipment, disruption to the MBTA can be minimized. The tie-in to the existing system at Land Boulevard will be simplified by utilizing the same equipment on the new alignment as the old. No revisions will need to be made to the MBTA's operating or maintenance procedures as the familiarity of the product and system is preserved.

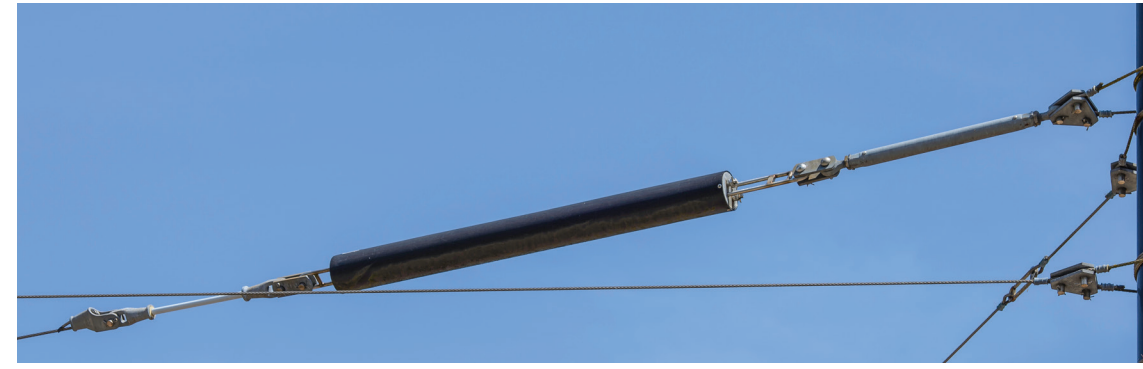

Figure 4.1-9. Example Spring Tensioner. Tension sections will be arranged around the yard to minimize the difference between the two trolley wires.

OCS Sectionalisation For Supporting Operations, Maintenance, and Overall Integration

The proposed design will be divided into power sections as mentioned in section 4.1.E.1 DC Power Distribution System and as shown in attached drawing SYS-004 and SYS-005. The sectioning allows discrete segments to be easily de-energized for emergency repair or planned maintenance while still providing service to the public by way of single tracking. The existing power section (S-8) will be further zoned into the same inbound/outbound power sections as the new Project and new supplemental feeders and feeder tap disconnect switches will be installed to support the zoning.

Disconnect switches for the yard power sections will be located centrally to allow easy operation and maintenance of the equipment.

Our design locates an overlap at the last span of the new viaduct which can be installed without demolition of the existing structure. This allows the OCS to be fully installed and tested west of the tie-in and will not be effected by further civil works. Once the old structure is removed, and the new viaduct married, only a short section of OCS will need to be installed and tested to provide the tie-in, reducing the duration for installation and testing.

OCS Pole Arrangements

The maximum allowable span lengths will be based on the calculated pantograph security using the UIC 606-1 leaflet along with AREMA and other industry standard best practices. The maximum span lengths and staggers will be selected such that the contact wire stays within the zone of the carbon strip under all adverse conditions. As the pantographs of the MBTA LRV's are not centered on the trucks, an allowance will be included in the calculation for curves to account for the pantograph centerline deviation from the track center. As necessary, the maximum allowable span lengths will be further reduced to $2\sqrt{Rc}$, where Rc is the curve radius, to meet Technical Provision requirements. The 6" safe zone from pantograph centerline as specified in the Technical Provisions will be verified by the pantograph security calculation and may be further reduced to provide safe operation.

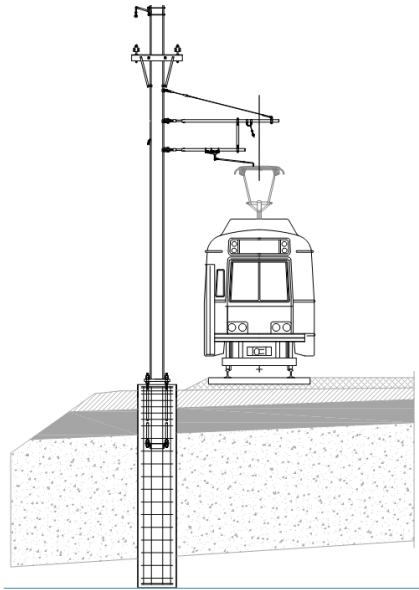

Figure 4.1-10. Typical Side Pole Arrangement. *Catenary above each mainline track will be supported from independent poles located to the sides of the LRV tracks whenever possible to increase the reliability of the system, increase safety of maintenance and account for track center constraints.*

Maximum allowable span lengths for particular track radiuses will be utilized where no other obstructions are limiting, such as special track work, underground utilities, or overhead structures. Span lengths will be gradually adjusted when increasing or decreasing to promote uniform pantograph performance throughout the system. A uniform system height will also be utilized over all unobstructed span lengths simplifying the installation effort and will be set based on the wire tension profile and minimum hanger length after the maximum tangent span length is established.

Poles will be hot dip galvanized steel with anchor base design and will be consistent with MBTA standards and existing poles. Wide flange poles will be utilized for the Medford and Union Square branch. Tubular poles are preferred in the yard due to accommodate the multiple load angles, as shown in Figure 4.1-10. Catenary above each mainline track will be supported from independent poles located to the sides of the LRV tracks to increase the reliability of the system and increase safety of maintenance as depicted in drawing SYS-002. Poles will be selected based on the Allowable Strength Design per the Technical Provisions to utilize only 2/3 the yield strength as well as limiting pole deflection. In addition, the pole selection will be checked using standard load factors according to NESC, AREMA, and AREA.

4.1.G AC VOLTAGE DISTRIBUTION

Typical AC Voltage Services

Typical AC voltage services with details of control and monitoring of services and equipment are shown in Figure 4.1-11.

Our design includes two independent 13.8 kV electrical services from Eversource for the Red Bridge Traction Power Substation (TPSS) and two independent 13.8 kV electrical services for the Pearl Street TPSS. Eversource requires installation of their standard electricity metering equipment at these substations solely for their own use, including potential transformers (PTs), current transformers (CTs), meters and communications. MBTA will need to obtain the same measurements obtained by the utility regarding electricity usage at these metering locations. To ensure this occurs, the digital substation automation system (SAS) that will be provided in each substation will duplicate the electricity metering functions provided by the utility's own metering equipment. The substation automation system includes the 13.8 kV PTs and CTs required for electricity usage measurements, and the necessary energy management software.

The SAS at each TPSS will also provide comprehensive local and remote monitoring of all substation equipment and critical building functions including fire, HVAC and access-related alarms, which will be visible to the SCADA master station at MBTA Power Control. It will provide data transfer, status indication, and control of all substation equipment per MBTA standard operating practice with which our Lead Designer, STV, is exceptionally familiar. Normal substation

control will be possible from the SCADA master station, from the local TPSS SAS HMI screen, and from the local TPSS AC circuit breaker control and instrument panel (ACCP).

Unit substations will also be similarly-equipped with SAS for remote monitoring and control via the MBTA SCADA Master Station, as well as local monitoring and control. To assist with energy management, the unit substation SAS will be utilized to provide electricity usage metering of the entire unit substation, as well as sub-metering of individual connected circuits including the Transportation Building. Refer to drawing SYS-006 for a typical unit substation SAS block diagram.

Description of Redundant Supply Methodology and the Application of UPS and Local Utility Feeds

The AC power distribution system is configured to provide full redundancy for all essential GLX project loads. This redundancy will assure system resiliency and reliability as well as simplifying routine maintenance and repairs. This redundancy is achieved at the three traction power substations by the utilization

Activity Grouping	Description	Sheet Reference:	Location of Feed	Cables:
Traction Power Substations	Ball TPSS	TRACTION POWER S-2426 AND S-2436	PEARL ST. TPSS FEED 1 PEARL ST. TPSS FEED 2	13.8kV AC FEED 1 [0-54-1] 13.8kV AC FEED 2 [0-54-2]
	Pearl TPSS	TRACTION POWER S-2426	Eversource Feed 1 Eversource Feed 2	(2) - 13.8kV AC FEEDS
	Red Bridge TPSS	TRACTION POWER S-2450	Eversource Feed 1 Eversource Feed 2	(2) - 13.8kV AC FEEDS
Signal CIHs	Lechmere CIH	TRACTION POWER S-2702	RED BRIDGE SUBSTATION Lechmere E-100 Lechmere Station	2#3/0 AWG AND #4 GND 2#1/0 & 1#6G in 2" C 4#1 & 1#6G in 1 1/2" C
	Red Bridge Main CIH	TRACTION POWER S-2705	RED BRIDGE SUBSTATION	4#1/0 AWG, 4#1 AWG AND 3#6 GND
	Brick Bottom CIH	TRACTION POWER S-2706	RED BRIDGE SUBSTATION	4#300 KCMIL, 4#2/0 AWG AND 3#4 GND
	Washington (E. Somerville) Satellite CIH	TRACTION POWER S-2708	PEARL ST. SUBSTATION	6#500 KCMIL AND 4#3 GND
	East Somerville E-100	East Somerville E-100	East Somerville Station	2#4/0 & #4G in 2 1/2" C
	East Somerville E-100	East Somerville E-100	East Somerville Station	4#1/0 & 1#6G in 2" C
	Washington (E. Somerville) Main CIH	TRACTION POWER S-2709	PEARL ST. SUBSTATION	6#500 KCMIL AND 4#3 GND
	East Somerville E-100	East Somerville E-100	East Somerville Station	2#300KCMIL & 1#4G in 3" C
	East Somerville E-100	East Somerville E-100	East Somerville Station	4#2/0 & 1#6G in 2" C
	Gilman CIH	TRACTION POWER S-2716	PEARL ST. SUBSTATION	4#1/0 AWG, 4#1 AWG AND 3#6 GND
	Ball Sq. CIH	TRACTION POWER S-2717	BALL SQ. SUBSTATION	4#1/0 AWG, 4#1 AWG AND 3#6 GND
	College Ave CIH	TRACTION POWER S-2723	BALL SQ. SUBSTATION	6#500 KCMIL AND 3#2/0 AWG GND
	College E-100	College E-100	College Station	2#1/0 & 1#6G in 2" C
	College E-100	College E-100	College Station	4#1 & 1#6G in 1 1/2" C
Red Bridge Satellite CIH	TRACTION POWER S-2725	RED BRIDGE SUBSTATION	4#300 KCMIL, 4#2/0 AWG AND 3#4 GND	
Union Sq. CIH	TRACTION POWER S-2730	RED BRIDGE SUBSTATION	6#500 KCMIL AND 3#3 GND	
Union E-100	Union E-100	Union Square Station	2#1/0 & 1#6G in 2" C	
Union E-100	Union E-100	Union Square Station	4#1 & 1#6G in 1 1/2" C	
Passenger Stations	Lechmere Station	TRACTION POWER S-2444	RED BRIDGE SUBSTATION	13.8kV AC FEED [0-52-1] 13.8kV AC FEED (Eversource)
	Lechmere E-100	Lechmere E-100		
	East Somerville Station	TRACTION POWER S-2419	RED BRIDGE SUBSTATION	13.8kV AC FEED [0-52-5] 13.8kV AC FEED (Eversource)
	East Somerville E-100	East Somerville E-100		
	Gilman Sq. Station	TRACTION POWER S-2426	PEARL ST. SUBSTATION	13.8kV AC FEED [0-53-4] 13.8kV AC FEED (Eversource)
	Gilman E-100	Gilman E-100		
	Magoun Sq. Station	TRACTION POWER S-2432	PEARL ST. SUBSTATION	13.8kV AC FEED [0-53-2] 13.8kV AC FEED (Eversource)
	Magoun E-100	Magoun E-100		
	Ball Sq. Station	TRACTION POWER S-2436	BALL SQ. SUBSTATION	13.8kV AC FEED [0-54-4] 13.8kV AC FEED (Eversource)
	Ball E-100	Ball E-100		
College Ave. Station	TRACTION POWER S-2442	BALL SQ. SUBSTATION	13.8kV AC FEED [0-54-3] 13.8kV AC FEED (National Grid)	
College E-100	College E-100			
Union Sq. Station	TRACTION POWER S-2460	RED BRIDGE SUBSTATION	13.8kV AC FEED [0-52-3] 13.8kV AC FEED (Eversource)	
Union E-100	Union E-100			
VMF Building	VMF-E-201			13.8kV AC FEED (Eversource)
Transportation Building	VMF-E-201	VMF BUILDING		3 SETS OF 4 #600KCMIL & #1G IN (3) 4" C. AND 4" C SPARE
Pump Stations	Red Bridge	TRACTION POWER S-2706	RED BRIDGE SUBSTATION	(4) #500 KCMIL AND (2) #500 KCMIL GND
	Gilman Stormwater Station	Gilman E-100	Gilman Station	4 #4 & #8G IN 1 1/4" C
	East Somerville Station	East Somerville E-100	East Somerville Station	2 SETS OF 4 #350KCMIL & 1#1G IN EXISTING CONDUIT

Figure 4.1-11. Typical AC Voltage Services with Details of Control and Monitoring of Services and Equipment.



The goal is to prevent failures from occurring and extending the service life of the capital plant. GLX Constructors will provide stray current corrosion control design elements that provide an economic approach to long-term performance.

of two independent 13.8 kV supply lines from Eversource at the Red Bridge and Pearl Street Traction Power Substations (TPSS), and the extension of the two independent 13.8 kV Eversource supply lines from Pearl Street TPSS to Ball Square TPSS. The 13,800-480/277 V unit substations within each TPSS will be double-ended, powered by a 13.8 kV feeder from each TPSS 13.8 kV bus. All critical loads in the TPSS buildings will be powered from automatic transfer switches (ATS) that can connect to either unit substation 480 V bus. Life safety TPSS building loads will also have Uninterruptible Power Supply (UPS) backup.

The passenger station substations at Magoun Square, East Somerville, Union Square, Ball Square, Gilman Square and Lechmere will each be powered by a 13.8 kV feeder from Eversource, as well as a backup 13.8 kV feeder from the nearest TPSS. College Avenue will be powered from a 13.8kV feeder from National Grid, as well as a backup 13.8kV feeder from the nearest TPSS. An ATS will automatically transfer from the normal utility feeder to the backup MBTA feeder in the event of a utility feeder outage. Life safety systems at each passenger station will be backed up by UPS systems as well as a separate UPS system to back-up security and communication systems. Lechmere Station will also be equipped with a natural gas powered emergency generator in accordance with the Technical Provisions.

The VMF Building will obtain power directly from a 13.8 kV Eversource service, augmented by a natural gas powered emergency generator for emergency and communications loads. The VMF Building main 480 V switchgear will feed the Transportation Building via a sub-metered circuit. Life safety loads in each both buildings will also have local UPS backup.

Central instrument House (CIH) signal equipment will be powered by dedicated 480 V feeders from the two nearest TPSS unit substation or passenger station substation; automatic transfer switches at each CIH will enable the signal equipment to be powered from either of these feeders, or from local UPS backup. Power to the communications rooms will be similarly redundant, including local UPS system backup.

Power to the Red Bridge pump station will be provided from two 480 V supply feeders from the Red Bridge TPSS unit substation, one from each 480 V bus. Power to the Gilman Square stormwater pump station and Washington Street pump station will be provided from Gilman Square and East Somerville passenger station substations respectively. The pump stations will be backed up by natural gas powered generators in accordance with the Technical Provisions.

4.1.H CORROSION CONTROL

Description of our Corrosion Control Strategy

GLX Constructors' team member, CorrTech, Inc., will study, evaluate, and mitigate the impact of corrosion on the Project. We will evaluate a variety of structures for corrosion exposure to develop a comprehensive corrosion mitigation program. Once identified, corrosion mitigation methods will be properly developed.

A baseline corrosion survey will be performed to determine soil corrosivity and identify other potential corrosion exposures along the Project corridor. This forms the basis for understanding and defining corrosion exposures that require mitigation. Stray DC current corrosion control design for running rail negative return transit systems will be implemented during final design elements in accordance with the guidance provided in the project Technical Provisions, Section 8.9.1, Stray Current Mitigation.

Methodology and Design for Controlling Corrosion

We will provide detailed specifications for material, surface preparation, application and final installation, dielectric strength evaluation and holiday testing. This will make sure that any stray current generated is contained in the ballast area of the structure and does not flow into viaduct reinforcement.

Precast prestressed concrete piles will be used for foundation support of the Vehicle Maintenance Facility and other ancillary buildings. Electrical continuity within the concrete piles or the steel elements would be established, with test wires and stray current monitoring capabilities provided. Where steel piles are used for foundation support, an allowance will be made for sacrificial steel as well as stray current monitoring capabilities.

Soil nail walls shall be provided with electrical continuity of the shotcrete mesh and reinforcement in the architectural wall. The soil nails are individual electrical elements and must be electrically isolated from each other as well as the reinforcing mesh and rebar. This requires electrical continuity is provided for the shotcrete wall mesh with properly sized mechanical crimps and tack welding of the reinforcing steel, with test stations 250-ft at intervals of physical break.

Mechanically stabilized earth walls, MSE, and modular precast wall sections would not have any metallic components in contact with the soil. No stray current design is required for these walls.

Soldier piles used for permanent retaining walls would be placed in drilled holes and backfilled with concrete. The soldier piles would be galvanized steel within the concrete encasement. The high resistance concrete encasement helps to provide electrolytic isolation and increased resistance to reduce the magnitude of resulting stray current. Electrical continuity of the H-piles will be provided with wire connections or wire mesh connections.

For the at-grade station and structures, all new construction shall be provided with stray current corrosion control. This includes bonding of the reinforcing steel for electrical continuity in pile caps and test stations and underground sections coated with dielectric coating to 12-in above finish grade.

For elevated stations, the use of dielectric coating to 12-in above finish grade of station and building components will be required. This will provide electrolytic separation in lieu of electrical bonding of reinforcing steel.

Qualified individuals within the CorrTech organization, based in New England, would provide the technical support required as related to stray current corrosion control. CorrTech provides in-house personnel who are NACE, API, ASNT UT, NASSCO PACP, EPRI, INPO, and OSHA certified.

Approach and Design Concepts for Reducing Stray Current

GLX Constructors’ team member, CorrTech, will work with the Traction Power design staff during final design to develop elements intended to minimize the generation of stray current. These concepts include maximizing rail to earth resistance, minimizing negative return resistances and minimizing track to earth voltage escalations.

Where stray current control elements in the Technical Provisions provide sufficient control, they would be applied in the final design. Where improvements to the stray current control approach can be made, the best practice approach would be developed. GLX Constructors will provide stray current control as detailed in the Technical Provision.

For the Viaduct structures, stray current control relies on the long term performance of a dielectric spray on membrane. GLX Constructors will provide detailed specification for material, surface preparation, application and final installation dielectric strength evaluation and holiday testing. This is critical as to ensure that any stray current generated is contained in the ballast area of the structure and does not flow on viaduct reinforcement.

Methodology for Monitoring and Metering Stray Current during Construction

CorrTech will also provide technical corrosion engineering support to the construction project for the various components of construction. Stray current control components, as they are specified for this Project, involve tack welding of reinforced steel in cast-in-place concrete, test wire and junction box installation, specialized coating application on areas of concrete structures, and QA/QC testing and documentation. GLX Constructors will be responsible for developing specific field test procedures that are required to demonstrate acceptable criteria for acceptance during and at the completion of key structures and corrosion control elements.

Final QA/QC documentation will be provided during the construction work and at project completion. GLX Constructors will provide qualified individuals to perform the field testing associated with the QA/QC oversight.

After construction and prior to energizing the Traction Power Station, a stray current survey will be planned and executed. We will submit a detailed survey plan to the MBTA for review and approval prior to execution of the survey. Test points, test procedures, test equipment, and testing personnel will be identified in the plan. The purpose of the survey is to document the baseline stray current

activity on the Project structures and adjacent underground utilities prior to energizing the traction power system.

Once the system is online and in revenue generation, a post stray current survey will be performed. This will follow and monitor changes in stray current activity as determined during the initial stray current survey. Test results and findings will be presented in a final report.

Description of Stray Current Best Practices

GLX Constructors’ team member, CorrTech, are active participants in the development and review of NACE, IEEE, and other applicable industry standards. CorrTech develops in-house Standard Operating Practices (SOP) to provide field testing personnel with the means and methods for evaluation and assessment during QA/QC testing. This experience and knowledge allows them to constantly stay abreast of and incorporate current industry best practices.

GLX Constructors’ Systems Integration Team will implement the approach as described within this section and will serve in a central role through all phases of design, construction, commissioning, and rail activation. This has proven itself effective on similar projects, and it will provide the MBTA with higher schedule and cost certainty.

RFP		
Drawing Number	Drawing Title	Reference Section or Drawing
		4.1 (Figure 4.1-5)
		4.2 (S-012)
	GLX Team will use MBTA Standard Drawings	MBTA DWG 2000, 2002, 615, 510, 2082, 2102
	GLX Team will use MBTA Standard Drawings	MBTA DWG 1225, 9269, 9245
SYS-001	OCS Typical Details – Conductor Particulars	
SYS-002	OCS Typical Details – Typical Side Poles – General Arrangement	
SYS-003	OCS Typical Details – Typical Low Clearance – General Arrangement	
SYS-004	Traction Power Single Line Diagram – GLX Main Line	
SYS-005	Traction Power Single Line Diagram – GLX Yard	
SYS-006	Substation Automation System (SAS) – System Block Diagram	
SYS-007	Special Trackwork Equipment Location Layout	

Technical Solutions Drawing Matrix.

AUTO-TENSIONED SIMPLE CATENARY			
CONDUCTOR PARTICULARS (UNWORN CONDITION)	UNITS	CONDUCTOR	
		CONTACT	MESSENGER
CONDUCTOR TYPE	-	4/0 KCML GROOVED	4/0 CW EK KCML 19 STRAND
MATERIAL	-	HARD DRAWN COPPER	HARD DRAWN COPPER
DIAMETER	IN.	0.482	0.571
CROSS SECTIONAL AREA	SQ. IN.	0.167	0.195
WEIGHT OF CONDUCTOR	LB/FT	0.6419	0.7484
WEIGHT OF SYSTEM (NOTE 1)	LB/FT	1.464	
RADIAL THICKNESS OF ICE (O)	IN.	0.5	0.5
WEIGHT OF ICE (O)	LB/FT	0.611	0.666
WEIGHT OF SYSTEM WITH ICE (O)	LB/FT	2.808	
CONDUCTOR BREAKING STRENGTH	LB	9154	15370
MAXIMUM SPAN	FT	145	
CONDUCTOR TENSIONS AT:			
60o F NO WIND	LB	3000	4000
CONDUCTOR SAG ON MAXIMUM SPAN AT:			
60o F NO WIND	FT	0.0167	0.962
SYSTEM HEIGHT	FT	2.5'-0" (NORMAL)	
CONTACT WIRE HEIGHT AT 60o F	FT	15'-0" (NORMAL)	
MODULUS OF ELASTICITY	PSI	1.70E+07	1.85E+07
COEFFICIENT OF EXPANSION	-o F	9.40E-06	9.40E-06
MINIMUM FACTOR OF SAFETY	-	3.22	3.84

AUTO-TENSIONED SIMPLE CATENARY			
CONDUCTOR PARTICULARS (WORN CONDITION)	UNITS	CONDUCTOR	
		CONTACT	MESSENGER
PERMISSIBLE WEAR	% OF AREA	30.00	-
WEIGHT OF SYSTEM (NOTE 1)	LB/FT	1.261	
CONDUCTOR BREAKING STRENGTH	LB	6053	15370
MINIMUM FACTOR OF SAFETY	-	2.26	3.84

SEMI-COMPENSATED SINGLE CONTACT WIRE			
CONDUCTOR PARTICULARS (UNWORN CONDITION)	UNITS	CONDUCTOR	
		CONTACT	MESSENGER
CONDUCTOR TYPE	-	4/0 GROOVED TROLLEY-80	
MATERIAL	-	HARD DRAWN COPPER	
DIAMETER	IN.	0.482	
CROSS SECTIONAL AREA	SQ. IN.	0.167	
WEIGHT OF CONDUCTOR	LB/FT	0.6419	
RADIAL THICKNESS OF ICE (O)	IN.	0.5	
WEIGHT OF ICE (O)	LB/FT	0.611	
WEIGHT WITH ICE (O)	LB/FT	1.252	
CONDUCTOR BREAKING STRENGTH	LB	10820	
RULING EQUIVALENT SPAN	FT	80	
CONDUCTOR TENSIONS AT: (NOTE 2)			
60o F NO WIND	LB	2425	
120o F NO WIND	LB	1575	
0o F NO WIND	LB	3750	
CONDUCTOR SAG ON RULING SPAN AT:			
60o F NO WIND	FT	0.212	
120o F NO WIND	FT	0.326	
0o F NO WIND	FT	0.137	
CONTACT WIRE HEIGHT AT 60o F	FT	16'-0" NOMINAL	
MODULUS OF ELASTICITY	PSI	1.70E+07	
COEFFICIENT OF EXPANSION	-o F	9.40E-06	
MINIMUM FACTOR OF SAFETY	-	2.89	

SEMI-COMPENSATED SINGLE CONTACT WIRE			
CONDUCTOR PARTICULARS (WORN CONDITION)	UNITS	CONDUCTOR	
		CONTACT	MESSENGER
PERMISSIBLE WEAR	% OF AREA	30.00	
WEIGHT OF CONDUCTOR	LB/FT	0.449	
CONDUCTOR BREAKING STRENGTH	LB	7574	
CONDUCTOR TENSIONS AT: (NOTE 2)			
60o F NO WIND	LB	2425	
120o F NO WIND	LB	1575	
0o F NO WIND	LB	3450	
CONDUCTOR SAG ON RULING SPAN AT:			
60o F NO WIND	FT	0.148	
120o F NO WIND	FT	0.228	
0o F NO WIND	FT	0.105	
MINIMUM FACTOR OF SAFETY	-	2.20	

NOTES:

- SYSTEM WEIGHTS SHOWN HAVE BEEN CALCULATED BASED ON STANDARD HANGER SPACING AND TYPICAL DESIGN HANGER WEIGHT.
- EQUIVALENT SPAN FOR FIXED TENSION CALCULATIONS IN Le -80 FT

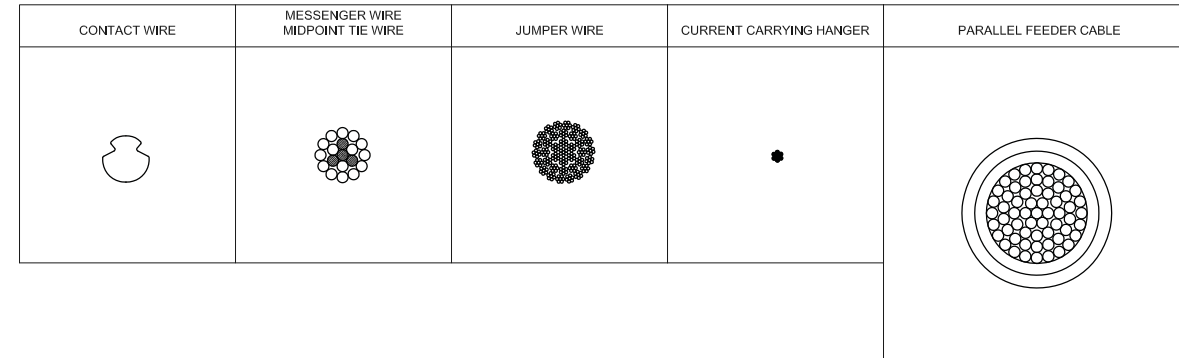

ANCILLARY WIRES	
DESCRIPTION	USAGE
WIRE ROPE 3/8", 1X7, EHS	TERMINATIONS
WIRE ROPE 3/8", 1X7, EHS	SPAN WIRES
WIRE ROPE, 3/16", FLEXIBLE BRONZE	HANGERS
4/0 AWG, STRANDED SOFT DRAWN COPPER, CLASS G, NON-INSULATED	IN-SPAN JUMPER
4/0 AWG, STRANDED SOFT DRAWN COPPER, CLASS G, INSULATED	FEEDER TAP
1,000 KCML, STRANDED SOFT DRAWN COPPER, INSULATED	POSITIVE PARALLEL FEEDER CABLE

PLOTTED: 06/14/17 2:54PM BY: JENKINS
 DRAWING: I:\PROJECTS\GLX\SYSTEMS\PROPOSAL_READY_DRAWINGS\OCS\PROPOSAL_DETAIL_DRAWINGS.DWG [SYS-001] 09/11/17 2:54PM

PROPOSAL

MASSACHUSETTS BAY TRANSPORTATION AUTHORITY



GREEN LINE EXTENSION PROJECT
 MBTA CONTRACT NO. E22CN04
 CAMBRIDGE/SOMERVILLE, MASSACHUSETTS

OCS TYPICAL DETAILS
 CONDUCTOR PARTICULARS

GV20170258-271.pdf



SCALE: NTS	DRAWN BY: BT	DESIGN BY: BT	CHECK BY: RS	PLAN NO.	ISSUE
DATE: SEPT. 28, 2017				SHEET: SYS-001	

PLOTTED: 06/14/17 4:58PM ETH:KINBAK
 DRAWING: I:\PROPOSALS\GLX\SYSTEMS\PROPOSAL_READY_DRAWINGS\OCS\PROPOSAL_DETAIL_DRAWINGS.DWG [SYS-002] 09/11/17 2:54PM

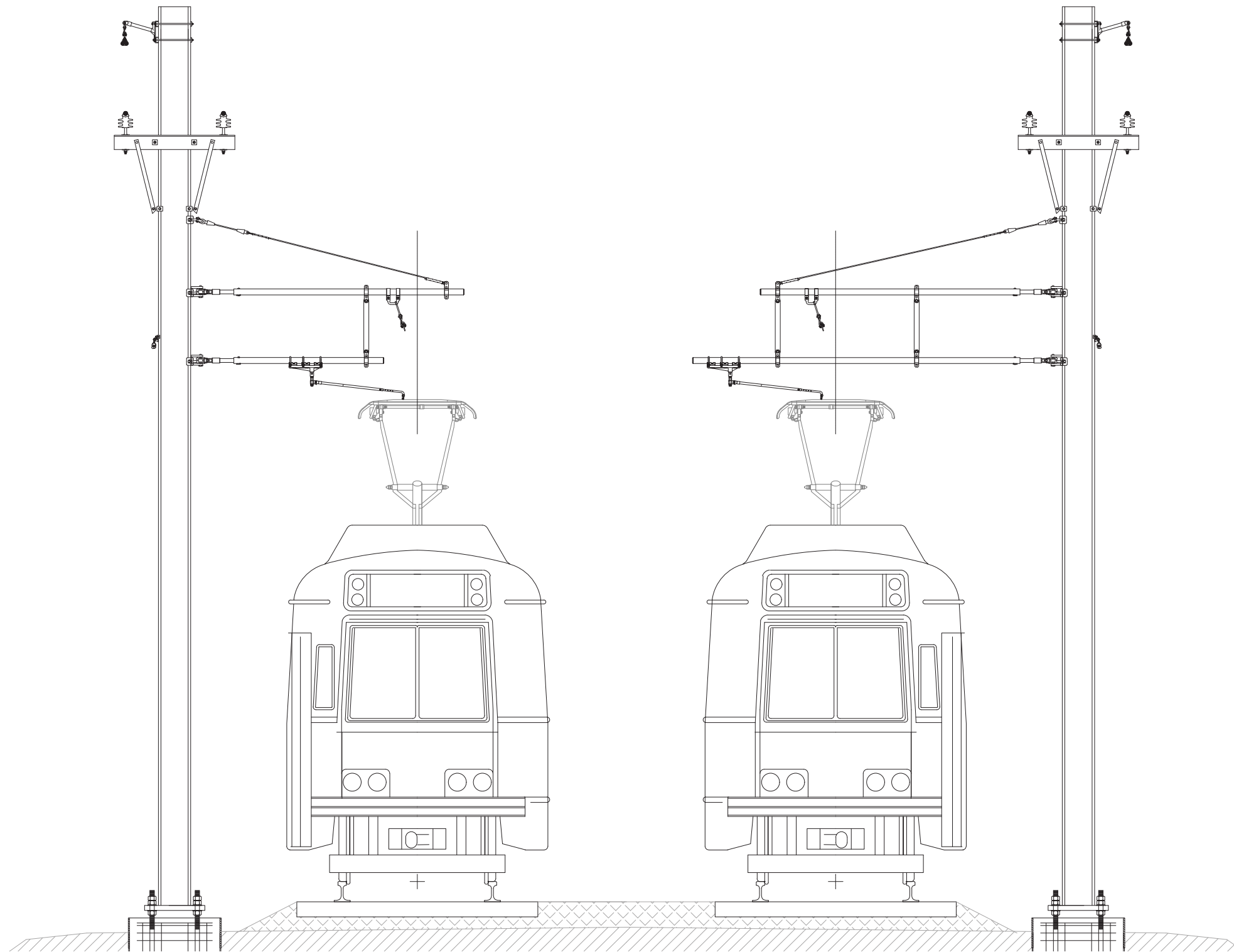

OCS TYPICAL DETAILS
TYPICAL SIDE POLE
GENERAL ARRANGEMENT

1/2" = 1'-0"

PROPOSAL

MASSACHUSETTS BAY TRANSPORTATION AUTHORITY



GREEN LINE EXTENSION PROJECT
 MBTA CONTRACT NO. E22CN04
 CAMBRIDGE/SOMERVILLE, MASSACHUSETTS

OCS TYPICAL DETAILS
TYPICAL SIDE POLES
GENERAL ARRANGEMENT



GV20170258-271.pdf

SCALE: 1/2" = 1'-0"		DRAWN BY: BT	DESIGN BY: BT	CHECK BY: RS	PLAN NO.	ISSUE
DATE: SEPT. 28, 2017					SHEET: SYS-002	
ISSUE	DATE	DESCRIPTION	BY	CHKD	APP.	

PLOTTED: 06/15/17 8:59PM E:\KINGMAK
 DRAWING: I:\PROPOSALS\GLX\SYSTEMS\PROPOSAL_READY_DRAWINGS\OCS\PROPOSAL_DETAIL_DRAWINGS.DWG [SYS-003] 09/11/17 2:54PM

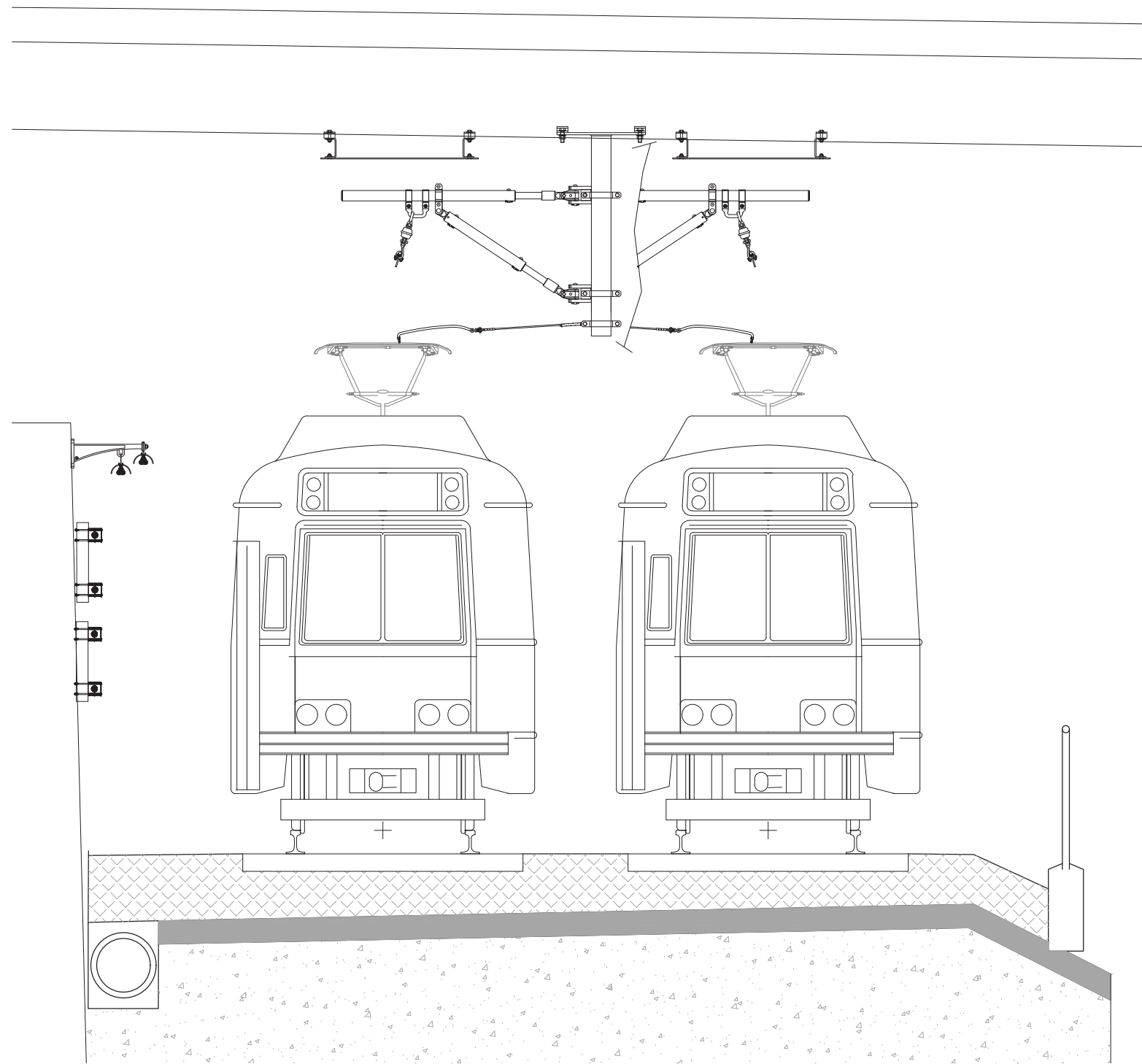

OCS TYPICAL DETAILS
TYPICAL LOW CLEARANCE
GENERAL ARRANGEMENT

1/2" = 1'-0" 0 1' 2' 4'

PROPOSAL

MASSACHUSETTS BAY TRANSPORTATION AUTHORITY



GREEN LINE EXTENSION PROJECT
 MBTA CONTRACT NO. E22CN04
 CAMBRIDGE/SOMERVILLE, MASSACHUSETTS

OCS TYPICAL DETAILS
TYPICAL LOW CLEARANCE
GENERAL ARRANGEMENT



GV20170258-271.pdf

SCALE: 1/2" = 1'-0"	DRAWN BY: BT	DESIGN BY: BT	CHECK BY: RS	PLAN NO.	ISSUE
DATE: SEPT. 28, 2017				SHEET: SYS-003	

ISSUE	DATE	DESCRIPTION	BY	CHKD	APP.

- NOTES:**
- THIS DRAWING IS A CONCEPTUAL AND SIMPLIFIED SINGLE LINE DIAGRAM OF THE PROPOSED TRACTION POWER SYSTEM.
 - 13.8 KV CIRCUIT BREAKERS FOR UNIT SUBSTATIONS AND PASSENGER STATION SUBSTATIONS ARE NOT SHOWN.

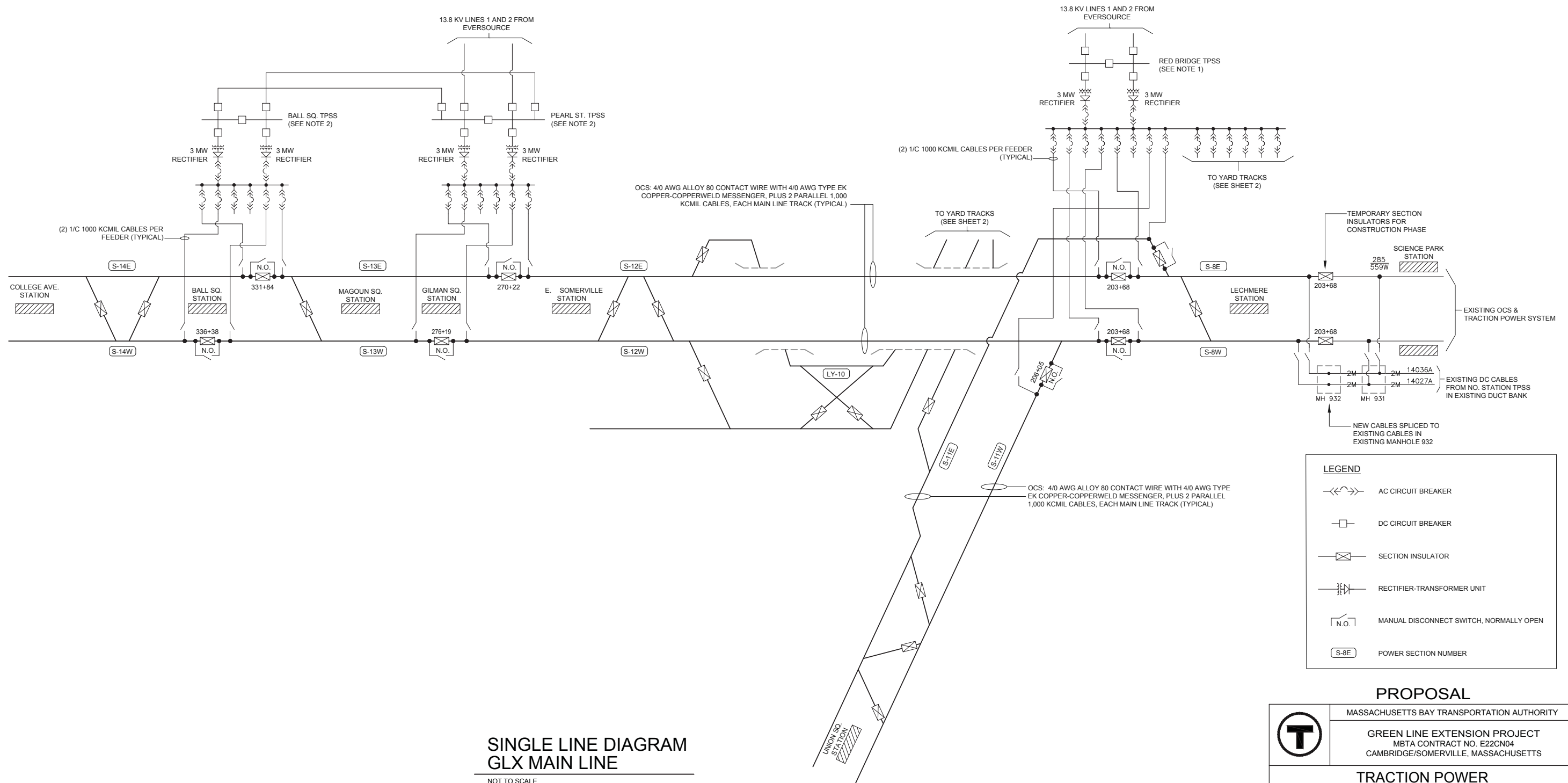

**SINGLE LINE DIAGRAM
GLX MAIN LINE**

NOT TO SCALE

PROPOSAL

MASSACHUSETTS BAY TRANSPORTATION AUTHORITY

T

GREEN LINE EXTENSION PROJECT
MBTA CONTRACT NO. E22CN04
CAMBRIDGE/SOMERVILLE, MASSACHUSETTS

**TRACTION POWER
SINGLE LINE DIAGRAM
GLX MAIN LINE**

STV 100 Years

massDOT
Massachusetts Department of Transportation

**GLX
CONSTRUCTORS**

GV20170258-271.pdf

SCALE: NTS	DRAWN BY: JAW	DESIGN BY: RWBS	CHECK BY: RWBS	PLAN NO.	ISSUE
DATE: SEPT. 28, 2017				SHEET: SYS-004	

PLOTTED: 06/15/17 8:58PM E:\KINGMAK
 DRAWING: I:\PROPOSALS\GLX\SYSTEMS\PROPOSAL_READY\DRAWINGS\TPSS\SYS-007 TP-SU-MAIN LINE_REV.DWG [SYS-007] 09/11/17 12:08PM

NOTES:

- THIS DRAWING IS A CONCEPTUAL AND SIMPLIFIED SINGLE LINE DIAGRAM OF THE PROPOSED TRACTION POWER SYSTEM FOR THE YARD AND VMF.
- LOCATIONS FOR FEEDER CABLE RISERS AND CONTACT WIRE JUMPERS ARE TO BE DETERMINED.
- THE YARD AND YARD LEAD OVERHEAD CONTACT SYSTEM IS COMPRISED OF A SINGLE 40 AWG ALLOY 80 CONTACT WIRE.
- THE FOUR TRACKS IN THE VMF WILL BE GROUNDED AND ISOLATED FROM THE YARD TRACKS WITH INSULATED RAIL JOINTS. A SEPARATE NEGATIVE RETURN CABLE WILL CONNECT THE FOUR VMF TRACKS TO THE RED BRIDGE TPSS NEGATIVE BUS.

LEGEND

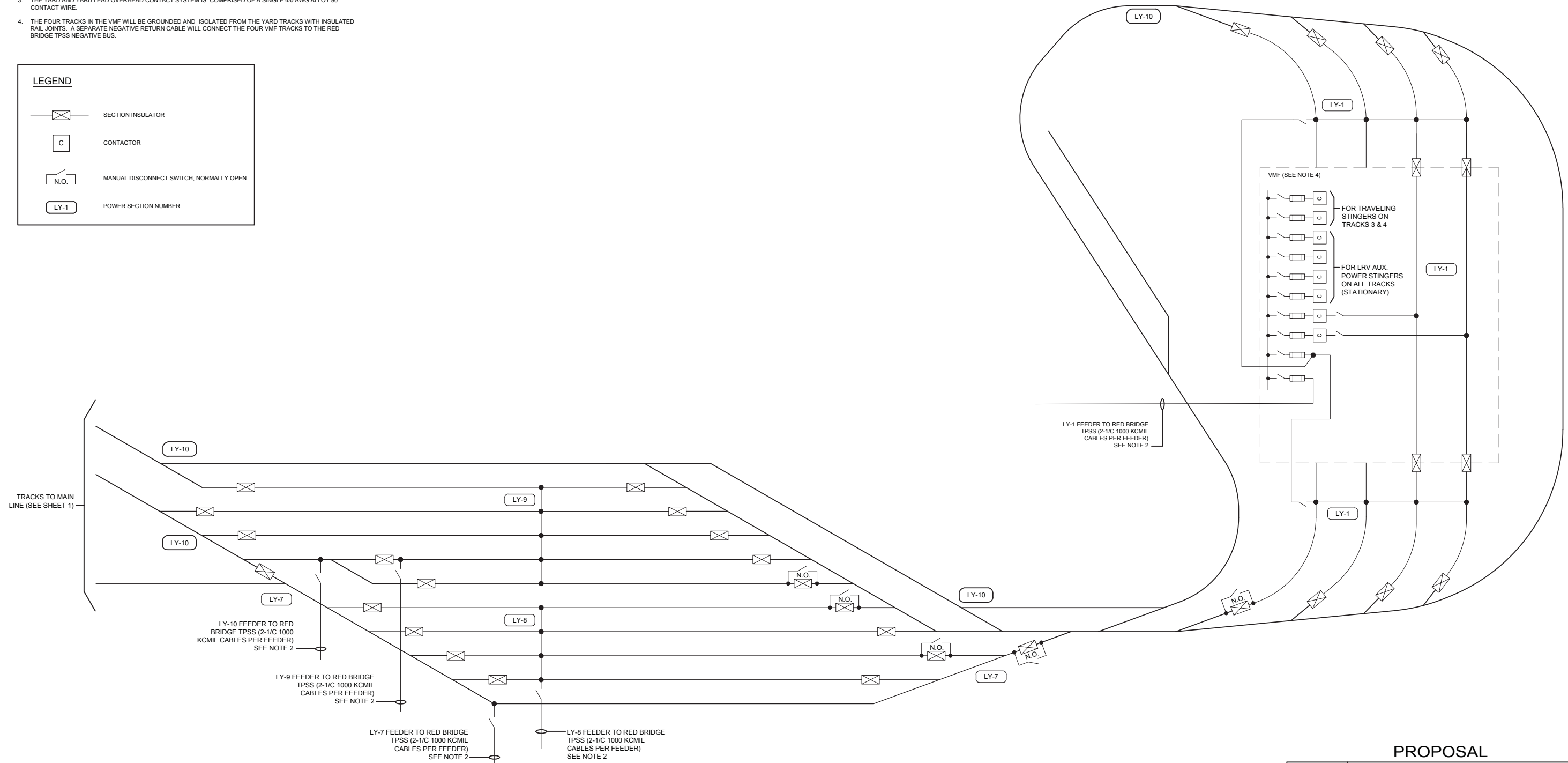
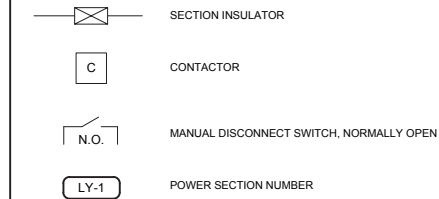

**SINGLE LINE DIAGRAM
GLX YARD**

NOT TO SCALE

PROPOSAL

MASSACHUSETTS BAY TRANSPORTATION AUTHORITY
T
 GREEN LINE EXTENSION PROJECT
 MBTA CONTRACT NO. E22CN04
 CAMBRIDGE/SOMERVILLE, MASSACHUSETTS

**TRACTION POWER
SINGLE LINE DIAGRAM
GLX YARD**

					
SCALE: NTS	DRAWN BY: JAW	DESIGN BY: RWBS	CHECK BY: RWBS	PLAN NO.:	ISSUE
DATE: SEPT. 28, 2017	BY:	CHKD:	APP:	SHEET: SYS-005	
ISSUE	DATE	DESCRIPTION	BY	CHKD	APP.

PLOTTED: 06/15/17 8:57PM ETH:KINBAK
 DRAWING: I:\PROG\GLX\SYSTEMS\PROPOSAL_READY\DRAWINGS\TPSS\SYS-005 TP-SU-YARD_REV.DWG [SYS-005] 09/11/17 12:13PM

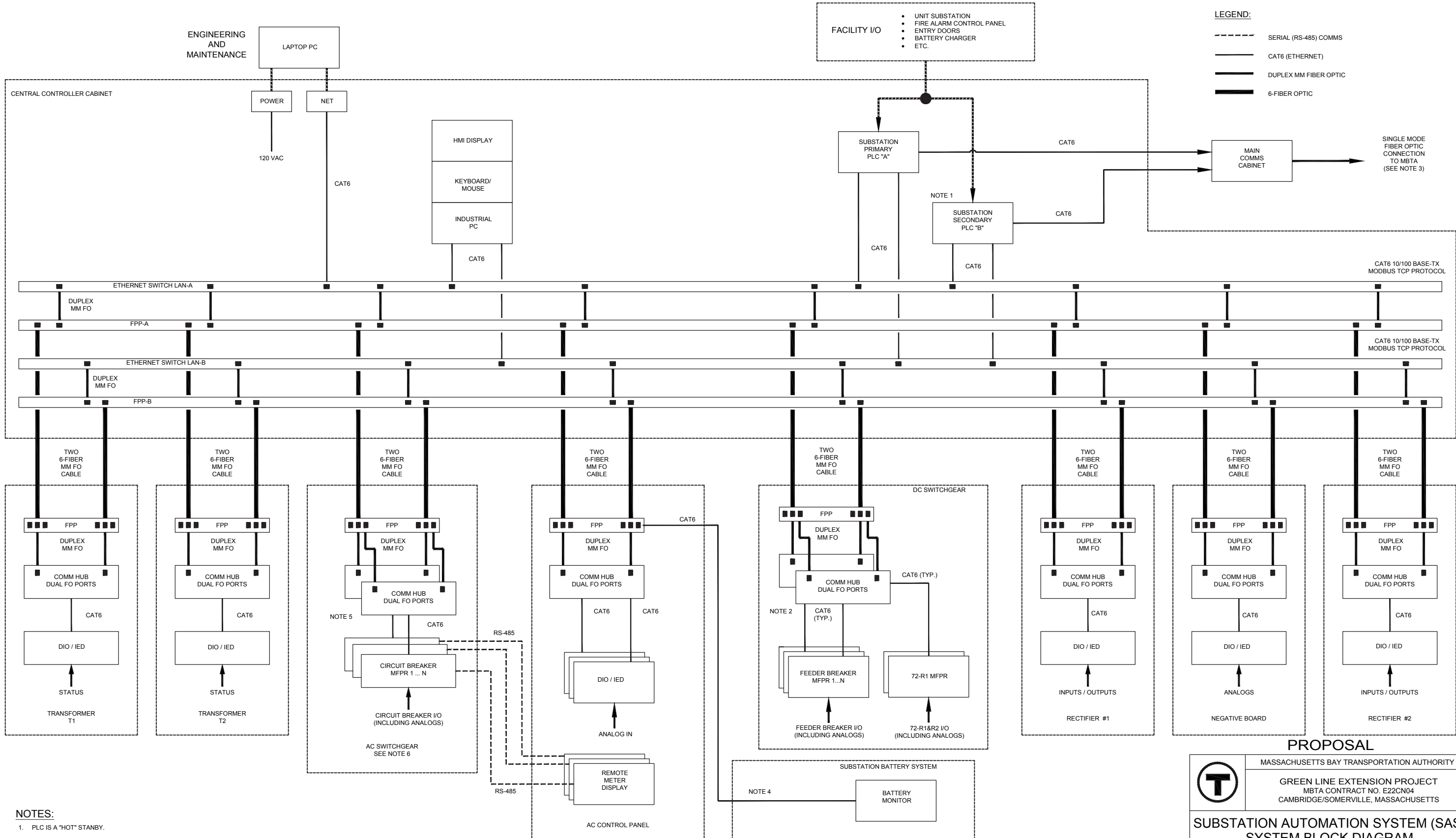

- FACILITY I/O**
- UNIT SUBSTATION
 - FIRE ALARM CONTROL PANEL
 - ENTRY DOORS
 - BATTERY CHARGER
 - ETC.

- LEGEND:**
- SERIAL (RS-485) COMMS
 - CAT6 (ETHERNET)
 - DUPLEX MM FIBER OPTIC
 - 6-FIBER OPTIC

- NOTES:**
1. PLC IS A "HOT" STANBY.
 2. THE NUMBER OF COMMS HUBS WILL VARY DEPENDING ON SWITCHBOARD SIZE.
 3. THE SAS MUST BE CAPABLE OF COMMUNICATING IN VALMET SERIES 5 PROTOCOL WITH THE MASTER SCADA STATION AT HIGH STREET

**SUBSTATION AUTOMATION SYSTEM
BLOCK DIAGRAM SHOWING MAJOR COMPONENTS**

NOT TO SCALE

PROPOSAL

MASSACHUSETTS BAY TRANSPORTATION AUTHORITY

T

GREEN LINE EXTENSION PROJECT
MBTA CONTRACT NO. E22CN04
CAMBRIDGE/SOMERVILLE, MASSACHUSETTS

**SUBSTATION AUTOMATION SYSTEM (SAS)
SYSTEM BLOCK DIAGRAM**

SCALE: NTS	DRAWN BY: JAW	DESIGN BY: RWBS	CHECK BY: RWBS	PLAN NO.:	ISSUE
DATE: SEPT. 28, 2017	DATE:	DATE:	DATE:	SHEET: SYS-006	ISSUE
ISSUE	DATE	DESCRIPTION	BY	CHKD	APP.

PLOTTED: 06/14/17 2:58PM E:\KINBAK DRAWING: I:\PROG\SA\SAS\SYSTEMS\PROPOSAL_READY DRAWINGS\TPSS\SYS-006.DWG [SYS-006] 06/14/17 2:58PM

GV20170258-271.pdf

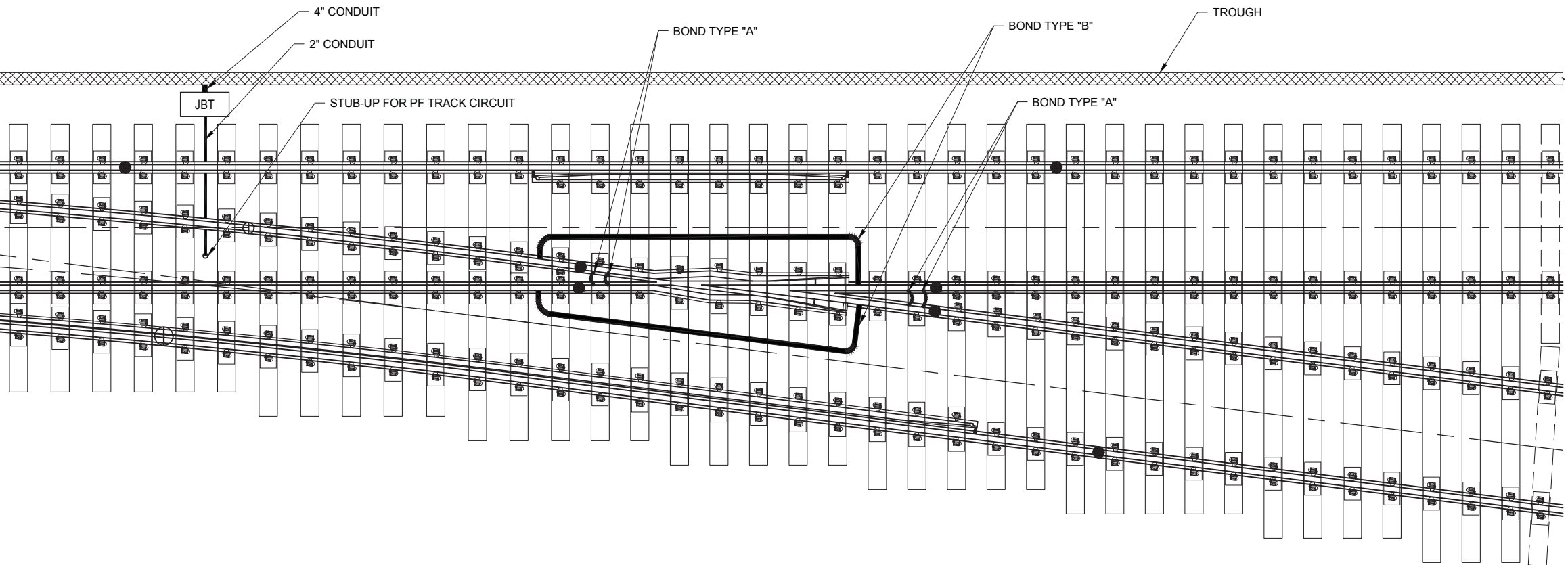
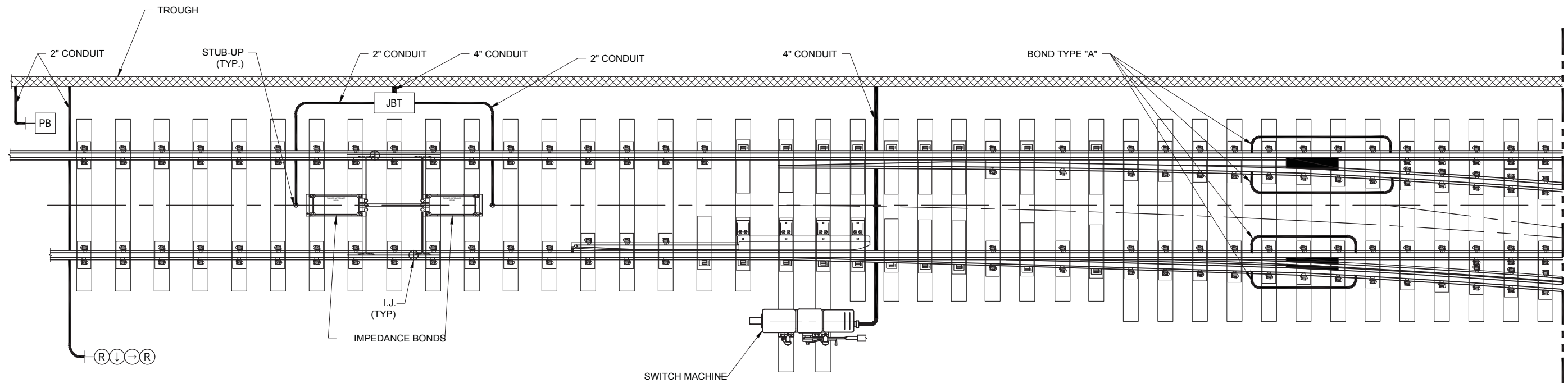

- NOTES:**
1. PROVIDE HMA UNDERLAYMENT IN ACCORDANCE WITH MBTA RAILROAD OPERATIONS STANDARD DWG NO. 1030.
 2. MANUFACTURER SHALL SUPPLY FLANGE BEARING FROG.
 3. TURNOUT SHALL BE FULLY GUARDED.
 4. GUARD RAIL GAPS ARE REQUIRED AT SPECIAL TRACKWORK.
 - 4.1. SEE TRACK DETAIL SHEETS FOR FURTHER INFORMATION.

- LEGEND**
- INDICATES RAILS FURNISHED BY THE MANUFACTURER
 - INDICATES RAIL FURNISHED BY THE INSTALLER
 - ⊕ INDICATES INSULATED JOINTS WITH 3/16" OPENING
 - INDICATES JOINTS TO BE FIELD WELDED
 - ⊗ INDICATES JOINTS TO BE BOLTED
 - AB INDICATES RAIL BRACE LOCATIONS
 - A (2) 250 KCMIL RAIL JOINT BONDS
 - B (1) 500 KCMIL RAIL JOINT BONDS

PROPOSAL

MASSACHUSETTS BAY TRANSPORTATION AUTHORITY
 GREEN LINE EXTENSION PROJECT
 MBTA CONTRACT NO. E22CN04
 CAMBRIDGE/SOMERVILLE, MASSACHUSETTS

**SPECIAL TRACKWORK
 EQUIPMENT LOCATION LAYOUT**

**SPECIAL TRACKWORK
 EQUIPMENT LOCATION LAYOUT**

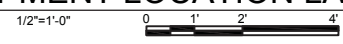

PLOTTED: 06/15/17 8:57AM E:\KINGMAK
 DRAWING: I:\PROPOSALS\GLX\SYSTEMS\PROPOSAL_READY_DRAWINGS\TRACKWORK\SYS-CL-8012.DWG [SYS-CL-8012] 09/11/17 10:00AM

SCALE: AS NOTED	DRAWN BY	DESIGN BY	CHECK BY	PLAN NO.	ISSUE
DATE: SEPT. 28, 2017	LYR	JCT	RAM	SHEET: SYS-007	
ISSUE	DATE	DESCRIPTION	BY	CHKD	APP.

GV20170258-271.pdf

4.2 ELEVATED GUIDEWAY AND STRUCTURES ALONG THE GUIDEWAY

The proposed solutions for the retaining walls, viaducts, and bridges are based on proven structural systems, which will be designed and built to MBTA and MassDOT Standards. GLX Constructors will deliver reliable structural solutions that meet service life expectations, and economical maintenance costs.

4.2.A STRUCTURES ALONG THE GUIDEWAY

The Lechmere, Medford Branch, and Union Square elevated guideway includes approximately one mile of elevated structure. Other structures along the guideway include bridges, stations, retaining walls, noise walls, and in localized areas an elevated Community Path. This section describes our design and construction approach for these structures.

Viaduct. The elevated guideway will consist of approximately 4,300 feet of viaduct structure and 1,600 feet of earthen embankment supported by Mechanically Stabilized Earth (MSE) retaining walls. The use of MSE walls was approved by the MBTA as part of GLX Constructors (ATC 35). ATC 35 is a significant reduction in long-term maintenance cost for the MBTA. The locations of the MSE supported earthen embankment portions of the elevated guideway are shown on Figure 4.2-1.

The Viaduct structure will match the alignment of the Project Definition Plans, with one exception. GLX Constructors team has identified a recently completed structure within the Northpoint development at approximately STA MB-EB 197+00 that extends into the MBTA permanent easement and conflicts with the viaduct structure, based on the track alignment shown on the Project Definition Plans. We have modified the track alignment extending north from Lechmere Station through STA 197. Based on the information provided by the MBTA, we believe that we have now resolved this bump out conflict, while keeping the viaduct within the MBTA ROW, and meeting all other design criteria.

The proposed Viaduct profile will be adjusted to provide specified vertical clearances while minimizing rail elevation above existing grade. Reduction in rail elevation on the viaduct reduces viaduct height, the over weight of the viaduct structure, results in smaller foundations.

The Medford Branch profile will be lowered by up to 6 feet between STA 186+00 and STA 207+00. This profile change will provide the required track grades and clearances for both a viaduct structure and for MSE wall supported earthen embankment. The proposed Medford Profile revision does not impact the viaduct structures already built in the advanced contract.

Details of the profile lowering include:

1. The maximum profile lowering of 6.5 feet is at STA 198+25 (north of Water Street).

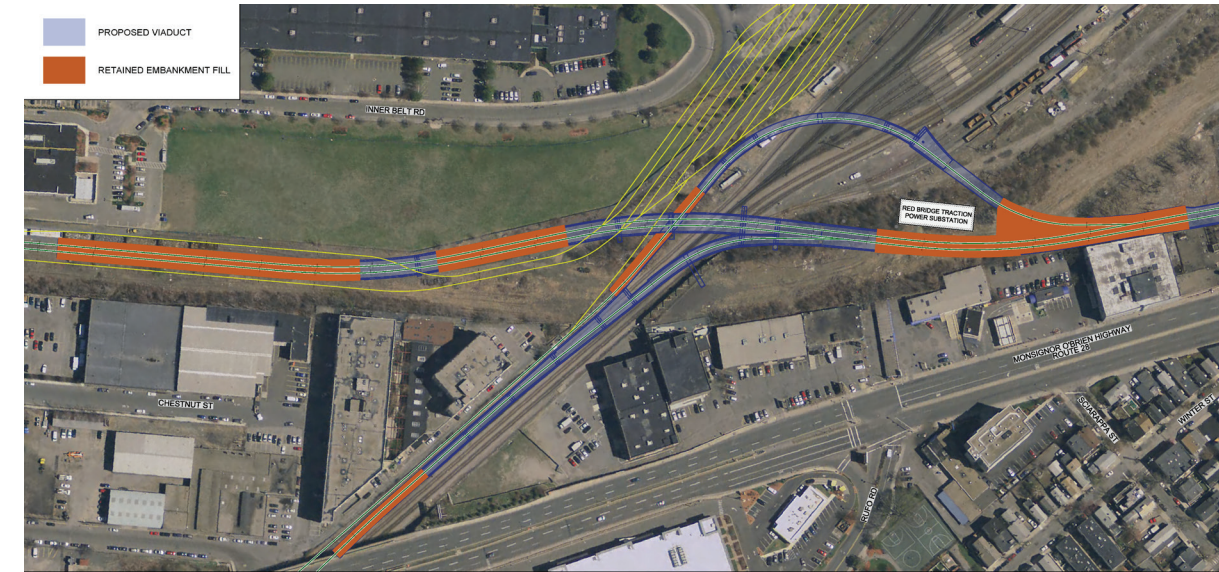

Figure 4.2-1. Locations of MSE supported elevated guideway structure. MSE supported elevated guideway approved as part of ATC 35 reduces risk associated with construction of deep foundation elements and reduces MBTA long-term maintenance costs.

2. Revised profile over Water Street meets the minimum 16.5 feet Vertical Clearances per Technical Provision 8.7.3.9.
3. Profile over Bus Turn-Around exceeds the minimum 12.5 feet Vertical Clearances per Technical Provision 7.2.3.6.
4. Revised Medford Profile grade does not exceed 2.00%, maximum grade in Technical Provisions 10.2.3.2(d)(ii) for special trackwork.

The profile through the Lechmere Station will be lowered by a maximum of 2 feet at the north end, allowing for a slight reduction in the size of the Lechmere Station. The profile grade through the station is lower than the maximum per the Technical Provision 10.2.3.2(d)(ii) for Station Platforms.

The Union Square Branch east-bound profile was also lowered from STA 0+00 to STA 6+90 to match the revised Medford profile. The Union Square Branch west-bound profile was not lowered.

The Medford Branch Profile may be lowered further in the East Street area by about 4 feet if the MBTA agrees a lowering of the reinstated historic Lechmere Viaduct. This would allow for substantial to efficiencies at the Lechmere Station.

Track Bed. Ballasted track will be used on the viaduct and will reduce loads generated by expansion/contraction of the continuous welded rail. Ballasted track allows for simpler superstructure deck joints at the termination of each span and acts to reduce dynamic impact on the superstructure system, which provides a better ride for passengers. Ballasted track represents a benefit for the MBTA as track maintenance can be performed with standard equipment.

Steel beams supporting a cast-in-place concrete deck will form the superstructure system. Steel has been selected over concrete because of weight

considerations, ease of erection, and the availability of the steel plate, which had been previously purchased. Steel plate girders, have been selected over tub girders, due to lower fabrication and detailing cost.

Viaduct Structure. We have reviewed the available steel that is now located at the High Steel and Casco Bay Fabrication Plants, as well as the list of available plate sizes and thicknesses. GLX Constructors has performed an independent design verification of the plans produced for the viaduct under the previous Contract, for both the superstructures and substructures. The steel that is available is suitable for reuse using the viaduct pier spacing proposed in the previous contract, with one exception on the Union Square Westbound Viaduct, one span has deflections under live load which were found to exceed allowable, and which will require a slight increase in girder stiffness.

We have identified the following improvements to the previous contract:

- ▶ Use of steel plate girders to replace tub girders.
- ▶ Elimination of counterweights on single tub girder spans.
- ▶ Our design replaces the counterweight/single tub superstructure approach with a three I-Girder system.
- ▶ End diaphragm configuration have been reworked to produce a simpler and less fatigue prone system, that we will be simpler to inspect
- ▶ Reworking of the proposed deck reinforcing to a more efficient configuration that will also accommodate proper placement and consolidation of deck concrete.
- ▶ Reconfiguration of Piers 7 through 11 to eliminate the arch in the underside of the pile cap. The underside arch generates problematic reinforcing bar detailing.
- ▶ Use of 30-inch diameter pipe piles instead of drilled shafts to address the uncertainty in determining the depth of rock sockets needed for drilled shafts.
- ▶ The use of earthen embankments supported by MSE walls to replace portions of the elevated viaduct structure that reduce long-term maintenance costs and risks associated with the installation of deep foundations in highly variable ground conditions.

The design will be performed in accordance with MBTA Guide Specification for Structural Design of Rapid Transit and Light Rail Structures, dated 2005. To address seismic loading, a Multimode Spectral Analysis will be performed in conformance with the AASHTO Code. The multimode analysis is appropriate given the length of the structure, and the variation in pier heights.

Viaduct Foundations. Foundations for the Viaduct will consist of drilled shafts, driven piles and drilled micropiles that will support vertical and lateral loads.

Drilled micropiles will be used to support Piers 1 through 7. The micropiles will be installed below the existing viaduct structure prior to demolition of the existing viaduct so that rail operations can remain active as long as possible. We also propose to utilize micropiles having a higher capacity than those shown on the drawings from the previous contract to reduce the required number of piles at these seven piers. The micropiles are designed to derive their support entirely in bedrock. These seven spans will be broken into their own Design Package. A dedicated Design Package will facilitate completing both the design and construction of the remaining Lechmere Viaduct north of these seven spans prior to commencing demolition activities. These seven replacement spans will be designed and constructed in a manner that will minimize track outage time.

Driven, 30-inch diameter, open ended pipe piles with a wall thickness of 1.25 inches will be used to support Piers 8 through 20. Piles will be designed to have a nominal axial resistance of approximately 600 kips for the Lechmere Branch Viaduct and about 800 kips for the Medford Branch Viaduct. A 1/8-inch allowance for corrosion will be provided both the inside and outside of the piles, as required by the Technical Provisions. A driving shoe will be installed on every drive pile. Aside from the favorable ground conditions, there are essentially three advantages of using piles instead of drilled shafts:

1. Every pile will be driven to a specified driving resistance, and at least two piles in each pier will be dynamically tested using a pile driving analyzer (PDA). Therefore, there will be a higher degree of quality control for a pile foundation compared to drilled shafts, where there will only be a limited number of load tests.
2. Potentially contaminated soil must be removed for drilled shafts. At Pier 18, contaminated soil and groundwater was encountered at a depth of about 65 feet. As a mitigation measure, the design shown on the GMP drawings included the installation of a costly, permanent steel casing at drilled shafts in this location.
3. Piles can be installed more quickly than drilled shafts.

Pending the results of our supplemental explorations, shallow foundations may be used as an alternative to piles at Piers 14 through 17, where the available subsurface information indicates that the thickness of "unsuitable" bearing material in this area is expected to be less than about 10 feet. The use of spread footings at the adjacent 22 Water Street development supports the likelihood of using spread footings in this area. The new Viaduct footings will extend to a depth of about 10 feet below existing grade to avoid imposing lateral pressures on the 22 Water Street foundation wall that extends about 10 below grade.

The remaining piers of the elevated viaduct will be supported on drilled shafts, primarily because the shafts are within the zone of influence of existing active tracks. Drilled shafts have already been installed at Piers 26 and 27 by the previous contractor as shown in Figure 4.2-2. We will review the installation records for these shafts and evaluate whether they are adequate to support the required design loads.



Figure 4.2-6. Viaduct Foundations at MSE wall interface. Viaduct foundations will not bear on the MSE embankments.

to a viaduct structure. We will construct these viaducts with butted prestressed concrete deck beams topped with a concrete wearing surface. Concrete curbs and fencing will be located outside the 12' – 0" wide pathway. Foundations will consist of a single drilled shaft supporting the reinforced concrete pier caps.

Narrative Demonstrating How the Elevated Guideway, Structures Along the Guideway Conform to Requirements

Adding the new Medford Branch (MB) tracks will require widening the existing track bed along several portions of the alignment north of the viaduct structure. To accomplish this, we will construct permanent retaining walls to support the adjacent ground and protect the integrity of the existing buildings and properties. New retaining walls will also be constructed to support the track bed in areas where the adjacent Community Path is depressed. Because of their deterioration, the face of some of the existing crib walls will also be repaired or rehabilitated. In addition to retaining walls, we will replace an existing railroad bridge and lengthen existing vehicular bridges to accommodate the new Green Line tracks and added Community Path.

We have based the type of retaining walls used and the approach to widening the existing bridge structures shown on the Definition and Concept Drawings in the Technical Provisions on site-specific ground conditions, geometry, maintenance, protection of existing structures, and other restraints, such as ROW restrictions and maintenance of railroad operations during construction. The majority of the new retaining walls involve the use of precast concrete elements, which will accelerate wall construction and eliminate the need for special measures associated with cast in place concrete placement in cold or inclement weather.

We will primarily use five types of retaining walls:

1. We will use **modular precast gravity walls** where the retained height is less than approximately 10 feet as shown in Figure 4.2-7. The use of precast elements for these relatively low height walls will shorten the construction schedule. Existing granite block walls may be used, in lieu of precast modular walls for wall heights up to about 4 feet, which match the existing historical granite blocks on the ROW.
2. We will use **drilled in cantilever soldier pile and precast concrete lagging walls** where the height of retained soil is greater than about 10 feet and the ROW restrictions prevent open cut excavations, or where limiting ground movements are required to protect adjacent structures. When there is a sufficient distance between the wall and the ROW, tiebacks may be used to reduce the size of the soldier pile, depth of embedment, and horizontal deflection at the top of the wall. See example in Figure 4.2-8.
3. **Soil nail walls with permanent shotcrete facing** will be used for excavations greater than approximately 10 feet, where soil nails can be installed within the Project's ROW.



Figure 4.2-7. Precast Modular Black Walls. Modular walls will accelerate wall construction.

Soil nail walls with permanent shotcrete facing will also be used to rehabilitate the two sections of deteriorated crib walls between McGrath Highway and Central Street. The results of nondestructive testing performed by NDT Corporation in their report dated December 2016 indicates that nearly one half of the transverse structural elements of the two wall sections are deteriorated. Therefore, we will construct a new wall system that not only provides a new facing, but is designed to support all the earth pressure without any contribution of the existing crib wall. See example in Figure 4.2-9.

4. We will use **cast in place reinforced concrete cantilever walls** in place of gravity walls to support new track embankments, at locations where MSE walls are not practical.
5. **Mechanically Stabilized Earth (MSE)** walls will be used around the perimeter of the Vehicle Maintenance Facility and Yard, and for support of the elevated guideways shown in Figure 4.2-10. Horizontal, non-biodegradable, reinforcing geogrid or galvanized steel reinforcing strips will be installed at 12 to 18-inch intervals as the backfill behind the precast concrete walls panels is placed.

Design Criteria and References to the Applicable Standards.

We will design all new retaining walls and noise barriers for a 75-year design life. The new structural elements of retaining walls to be rehabilitated will be designed for a 25-year design life. For the 'rehabilitation' of the existing wall between the McGrath Highway and Central Street, GLX Constructors is providing a new wall system that will exceed the required 25-year design life.

All new retaining walls will be designed to conform with the current American Association of State Highway and Transportation Officials (AASHTO) Load and Resistance Factor Design (LRFD) Code for geotechnical stability and structural component design.

All noise barriers will be designed to conform with the current AASHTO LRFD Code for geotechnical stability and the AASHTO Standard Specifications for Highway Bridges 17th Edition 2002 with latest interims using Load Factor Design (LFD) for concrete design and Allowable Stress Design (ASD) for steel design.

When loading conditions are not defined in AASHTO, such as building surcharge and commuter/freight rail the Massachusetts State Building Code and the American Railway Engineering and Maintenance-of-Way Association will be used, respectively.



Figure 4.2-8. Soldier Pile and Precast Concrete Lagging Wall Construction. Use where open-cut excavation is precluded and to limit ground movement adjacent to existing structures.



Figure 4.2-9. Permanent Soil Nail Wall. Soil nails provide an efficient structural solution where ROW is available.



Figure 4.2-10. Approximate Limits of MSE Retaining Walls at the Vehicle Maintenance Facility. MSE walls around the VMF facility allow for the site grade to be raised out of the flood plain and to maximize the use of available space for train storage.

Design or Specification Measures to Meet Serviceability Criteria.

Measures that are incorporated in our design to enhance the design life of retaining structures and noise walls are detailed below.

- ▶ GLX Constructors will provide proper drainage behind all new soldier pile and precast lagging walls and soil nail retaining walls to prevent the buildup of water pressure that could impact the life of the walls or result in maintenance issues. Free draining backfill will be used behind cast-in-place, modular precast concrete block walls and MSE walls to provide proper drainage.

Drainage behind the walls also prevents water seepage between precast panels or modular wall sections that could cause deterioration and/or discoloring of the concrete. In winter conditions, the seepage would result in the formation of ice on the wall that would be a safety concern for railroad maintenance workers. See example in Figure 4.2-11.

- ▶ We will provide a drainage swale, based on ground topography, along the top of soldier pile and soil nail walls for runoff from the back face of the walls.
- ▶ GLX Constructors will use precast elements where possible. These elements are fabricated under conditions that are not impacted by the harsh New England weather, and will be of higher quality than cast in place concrete.

- ▶ We will use hot dipped galvanized steel for permanent soldier pile and precast lagging systems. Steel angles attached to the pile sections will be attached prior to galvanizing to provide greater protection against corrosion.
- ▶ Neoprene rubber pads between precast concrete panels will be used for soldier pile and lagging walls to avoid damage to the precast panels due to overstressing associated with stress concentrations.
- ▶ GLX Constructors will use either hardwood lagging or shotcrete (at bridges and other critical areas) as temporary support at soldier pile and precast concrete lagging retaining walls. This will allow the excavation to be completed before installing the permanent precast panels and improve the aesthetics of the walls by allowing better alignment of the panels along the wall. The shotcrete will also allow panels to be replaced between any two adjacent soldier piles without any additional support if they are damaged during the life of the wall. Timber lagging will deteriorate over time, and will not provide the support needed to allow temporary removal of precast panels. Also, the deterioration of the timber lagging will result in ground movements behind the retaining wall that could cause distress to abutting structures. Therefore, we will only use timber lagging in non-critical areas.
- ▶ Shotcrete or timber lagging as temporary support for soldier pile and precast lagging walls will be installed using “clips” attached to the soldier pile between the flanges (see Figures 4.2-12 and 4.2-13) rather than using the back flange of the pile. This will require less excavation behind the face of the soldier pile, which will reduce the potential of ground movement behind the wall. Given the depth of the soldier piles that will be used for the higher walls, the reduction in the amount of excavation also accelerates construction.
- ▶ Individual segments of Precast modular walls can be easily replaced if damaged.
- ▶ Soldier piles will be installed so that the top of the pile is installed out of plumb by the amount of movement that is expected during excavation (after the pile is installed). This will provide a finish wall that is essentially vertical and will not



Light rail track supported by Mechanically Stabilized Earth (MSE) walls. GLX Constructors' team members, Balfour Beatty and STV, incorporated the use of low maintenance MSE walls on the Charlotte LYNX Blue Line Light Rail Project in North Carolina.



Figure 4.2-11. Installation of Drainage Board behind Shotcrete Walls. Where shotcrete is used, the boards will assure effective drainage behind the completed wall system.



Figure 4.2-12. Precast concrete panels and drilled soldier piles. GLX Constructors have experience with designing and installing drilled soldier pile and permanent precast concrete lagging walls using shotcrete as temporary support.

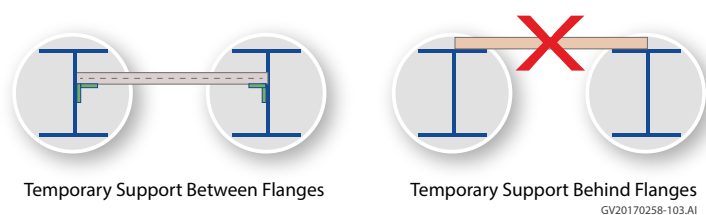

Figure 4.2-13. Preferred method of temporary lagging installation. Installing lagging between the soldier piles will reduce the potential of ground movement behind the wall.



Figure 4.2-14. Drilling Soldier Pile and Permanent Precast Concrete Lagging wall. Used for wall heights up to 28 feet without impacting adjacent structures.

have the appearance of tilting that may concern railroad operations or property abutters. Our team has used this approach successfully on this type of wall that was used to retain soil up to 28 feet in height, as shown in Figure 4.2-14. Also, piles will be installed by drilling, rather than driving, to maintain verticality and alignment.

- ▶ Coating of noise barrier panels with a penetrating concrete sealer to provide protection from freeze-thaw cycles.
- ▶ Limiting noise barrier deflection to 1% of the height of the noise barrier, which is well within the amount the segmental precast concrete panels can tolerate.
- ▶ Designing soldier piles structurally to limit wall deflection, rather than to maximizing the structural capacity of the steel section used. This will reduce the risk of potential impacts to adjacent structures.
- ▶ Enhancing the overall longevity and durability of the retaining walls and noise barriers by maintaining minimum cover requirements for all reinforcing steel.

Drainage and Waterproofing System for Structures, Type, and Application.

All new retaining walls will be designed to be free draining. A drainage board will be installed between the shotcrete and the soil face to provide drainage behind the soldier pile and precast lagging and soil nail retaining walls. The drainage board will be continuous from the top of wall to the base of the walls, and will drain into a crushed stone collector trench that runs along the length of the wall. The water from the collector trench will discharge into the main drainage system along the trackway. Crushed stone placed between the temporary shotcrete used between soldier piles and the precast concrete panels will also facilitate drainage. A drainage swale will also be provided along the top of the wall to divert surface runoff from the retaining walls. Free draining backfill will be used behind cast in place walls and modular precast walls or block walls.

Confirmation that all Structures can be Constructed within the ROW. GLX Constructors will work within the available ROW and easements in the layout and construction of the retaining walls along the guideway. However, the soil nails for retaining wall MW-10 near the College Avenue Station will extend a few feet outside of the ROW, as allowed by the MBTA.

Design to Mitigate Frost Heave. Mitigation measures for frost are incorporated into our design to reduce the risk of foundation heave and lateral load increase.

Steel piles used for the soldier pile retaining walls and noise walls will be installed in predrilled holes that extend below the frost depth.

Block and modular precast walls will be founded at least 18 inches below finish grade and are tolerant to heave. Also, a layer of crushed stone or other non-frost susceptible material will be provided below the gravity walls and below the precast panels used for the soldier pile and lagging walls and noise walls for drainage purposes. Furthermore, precast panels used for the soldier pile and lagging walls are very tolerant to movements. Therefore, vertical frost heave will not be an issue.

In terms of the potential for increased lateral load due to frost, drainage will be provided behind all new retaining walls, including soil nail walls. Our experience with these wall types in similar ground conditions throughout New England indicates that drainage behind the wall is sufficient to mitigate frost impacts.

Structural Drawings of the Elevated Guideway, Structures Along the Guideway

Structural drawings at the end of this section and indicate the retaining and noise wall types proposed for this project. Included in the drawings are section and elevation views and pertinent details to illustrate that the requirements of the Technical Provisions have been met.

4.2.B BRIDGE AND UNDERPASS STRUCTURES

General Approach to Bridge and Underpass Structures

Replacement bridges or modified portions of existing bridges will be designed for a 75-year service life. The Rail Bridge at Washington Street will be designed in conformance with the AREMA Manual for Railway Engineering and the MBTA Guide Specifications for Structural Design of Rapid Transit and Light Rail Structures. The Cooper E-80 plus diesel loading will be the design load for portions of the bridge supporting the commuter rail and maintenance tracks. Design loading for portions of the bridge supporting the Green Line tracks will be in accordance with MBTA Guide Specifications for Structural Design of Rapid Transit and Light Rail Structures.

Roadway bridges will be designed in accordance with the latest edition of the AASHTO LRFD Bridge Design Specifications and the latest edition of the MassDOT LRFD Bridge Manual. The HL-93 truck will be the design loading for replacement bridges or modified portions of existing bridges.

Approach to Modifying Existing Bridges and Constructing New Underpasses. Adding new Green Line tracks and a Community Path will require widening the existing track bed along many sections of the alignment north of the viaduct structure. To accomplish this, we will modify or reconstruct a dozen bridges within the corridor as shown in Figure 4.2-15. Site-specific ground conditions, geometry, constructability, maintenance, protection of existing structures, ROW restrictions, utilities, and maintenance of railroad and roadway operations during construction are all considered in development of our bridge plans.

For bridges to be modified (Lowell Street, Cedar Street, and College Avenue), we will retain as much of the original structure as is feasible. By doing this, we limit construction impacts to existing commuter rail operations and roadway users, while providing the MBTA with cost effective solutions.

As an example, the horizontal clearance between the train envelope and the existing abutment at Cedar Street Bridge is approximately two feet less than required to maintain a safe working distance. Therefore, in lieu of replacing the entire structure with a longer bridge, safety niches will be constructed into the existing abutment, thereby providing safe refuge areas for personnel working near the tracks. One of the wing walls will be reconstructed two feet further from the tracks for the same clearance reason. This work occurs away from the active tracks, does not impact roadway users and retains almost the entire bridge, which was constructed in 1999 and appears to be in relatively good condition.

	Year Built	Proposed Work	Rail Impacts	Roadway Impacts
Lowell Street	2006	Modify Abutment, Install Soil Nails for Lateral Loads	Minor	None
Cedar Street	1999	Install Safety Niches, Relocate One Wing Wall	Minor	None
College Avenue	1996	Remove Bridge Sidewalk, Widen Roadway, Construct Adjacent Pedestrian Bridge	Short Term During Bridge Installation	Minor

Figure 4.2-15. Overhead Structures to be retained and modified. A summary of the bridges with minor construction activity.

At the two proposed underpass locations, our approach is to construct a new back span that transforms a single span bridge to a two-span bridge. ATC 36 raises the Community Path to street level at the Walnut Street Bridge and eliminates the requirements for construction of a back span. Through this back span process, we retain one abutment and the existing superstructure, while converting the other existing abutment to a pier that supports the new span.

The benefits of this approach are:

- ▶ no demolition over active tracks;
- ▶ less disruptive construction activities impacting active tracks; and
- ▶ better experience for users of the community path and reduced ROW impacts.

At each of these locations, abutting buildings are close by and the available ROW is limited. For this reason, soldier piles and lagging (SPL) will be used to construct the new abutments. Soldier piles will be installed by drilling, rather than driving, to maintain verticality and limit vibration impacts to adjacent structures. The pile is installed out of plumb by the amount of movement that is expected during excavation (after the pile is installed). Piles will be socketed into bedrock to provide the required bearing and lateral capacities. After setting the soldier piles, the pre-drilled holes will be backfilled up to the finish grade in front of the wall using concrete backfill followed by lean mix or flow fill. Piles will be hot dipped galvanized to provide greater protection against corrosion.

Once the soldier piles are installed and the concrete backfill around the pile has sufficiently cured, the excavation and lagging system will be installed from the top down. Soils will be excavated and shotcrete installed as temporary lagging along the length of the soldier piles using the same technique described in "Design or Specification Measures to Meet Serviceability Criteria" above. When all lifts are complete, a permanent cast-in-place reinforced concrete facing will be attached along the front of the piles. Crushed stone will be placed between the shotcrete and concrete facing and weep holes will be constructed along the base of the permanent concrete façade for drainage. This type of construction was used successfully on the MBTA's Greenbush project.

Upon completing the soldier pile and concrete lagging permanent excavation support system, the abutment bridge seats will be constructed to support the additional span and approach slab. The back span for the School Street Bridge is relatively short and the proposed superstructure is separated-prestressed deck beams composite with a reinforced concrete deck slab. The back span for Medford Street Bridge has a high skew angle and longer span length (approximately 60 feet), and will be constructed using steel stringers composite with a reinforced concrete deck slab.

Proposed Track Structure/Rail Fastening Systems. To eliminate special fasteners, we will use a back-span approach in lieu of concrete box culverts for all underpasses, which will eliminate expansion joints below the track bed, as shown in Figure 4.2-16.

GLX Constructors' approach for all overhead structures and underpasses is to use a ballasted track on grade, which is the easiest system to repair and maintain.

Approach to Homogeneous and Uniform Waterproofing System Approach.

Over time, many reinforced concrete box culverts begin to leak. This typically occurs from hydrostatic pressures along the expansion and construction joints. Leaks will

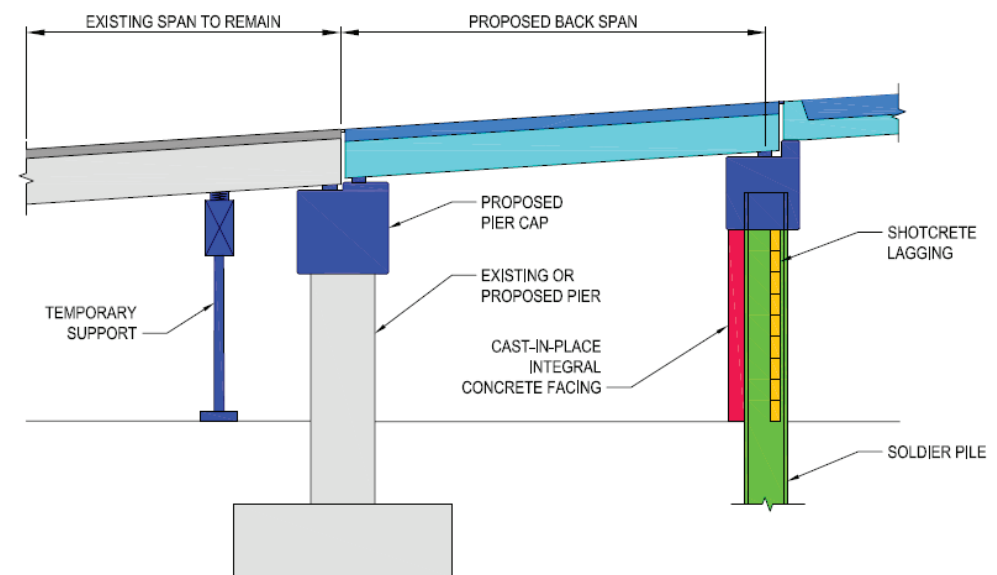

Figure 4.2-16. Proposed Back Span. Eliminates the need for an underpass structure to improve access and reduce maintenance.

form where abutting box sections have shifted, and by the eventual breakdown of the joint material or the box waterproofing system. Repairing these leaks is oftentimes both difficult and expensive. By using a new back-span for each of the underpasses, culverts and their associated waterproofing concerns are eliminated.

Reinforced concrete decks for all overhead bridges and overpasses will be protected by either an integral high performance concrete wearing surface or a hot mix asphalt wearing surface and membrane waterproofing that follows MassDOT standards for roadway bridges.

Description of the Site-Specific Approach to Bridge and Underpass Structures

The bridge work required is unique for each structure and varies from full bridge replacement to modest modifications such as frost protection measures or installation of safety niches. As such, our approach to upgrade these structures is also unique and is best described in the subparagraphs that follow.

Replacing the Railroad Bridge over Washington Street. Our approach to replacing the existing Washington Street Bridge entails the removal of the three-span superstructure and the two piers, and construction of a new single span superstructure with new abutments located behind the existing abutments as shown in Figure 4.2-17. The vertical clearance below the bridge will increase to 14' – 6" and coupled with the elimination of two piers, will open up sightlines for pedestrians and motorists. This single span option also eliminates joints in the deck, which are a continuing maintenance concern. The existing bridge will be demolished and reconstructed in two stages, with a minimum of two tracks available to support both the New Hampshire Mainline (NHML) and freight rail operations.

The new span will consist of welded steel thru-girders supporting rolled steel stringers and a metal deck pan. The bridge will support five tracks (1 Freight track, 2 (NHML) Tracks and 2 GLX Tracks) and a separate bay to support the Community Path. Track alignments will be modified from the Definition Plans, by locating the tracks closer together. This track realignment provides a more efficient bridge structure, pulling the community path away from the limited ROW line and improving access to East Somerville Station.

New abutments will be located behind the existing abutments, which will be retained to accelerate construction. Abutment foundations will consist of 4-foot diameter drilled shafts, socketed into the bedrock. A continuous reinforced concrete cap will support the girders and approach slabs. The new drilled shafts will allow for a slightly shorter, more efficient span length.

Construction of a Pedestrian Underpass Behind the Abutment of the Walnut Street Bridge. ATC 36 eliminates the need for construction of a new underpass at the southerly end of the bridge. The Community Path will be

raised and cross Walnut Street at street level, thereby providing an additional link between the pathway and local roadway system.

With the exception of potential frost protection measures, OCS protection board installation and modifications to the end posts, and approach guardrail and curbing, no other bridgework will be required. This will have a significant impact to local traffic, as pedestrians and vehicles will no longer be detoured during the construction duration for a new underpass. Another benefit is that disruptions caused by modifications to the large diameter waterline will be eliminated.

Construction of a Track and Pedestrian Underpass Behind the Abutment of Medford Street Bridge. Our approach to modifying the existing Medford Street Bridge retains the existing superstructure, modifies the bridge seat at the south abutment, and the constructs a new back span and abutment (see Figure 4.2-18). A single track of the Green Line (MB-WB) will pass below the new span.

The new span will provide a 5' – 6" sidewalk and a 16' – 6" travel lane in each direction, which will match the existing cross section. The existing 149' – 8 ½" span was constructed in 1983 and is composed of two main longitudinal steel thru-girders with transverse floor beams supporting a reinforced concrete deck and bituminous concrete wearing surface. The bridge was designed for an HS-20 loading and the proposed work will not reduce the current load capacity of the bridge. The new back span will be designed for an HL-93 loading and constructed using longitudinal steel stringers composite with a reinforced concrete deck slab and bituminous concrete wearing surface. Weathering steel will be used, with the ends of the beams either encased in concrete or coated to be consistent with the existing span. Due to the high skew angle, strip seal joints will be used at the interface with the existing span and at the new southerly



Figure 4.2-17. Washington Street Bridge. Our approach is to replace the existing three-span bridge with a new single span superstructure which will provide better lighting and access for pedestrians.



Figure 4.2-18. Medford Street Bridge. Our approach to modifying the existing bridge retains the existing superstructure, modifies the bridge seat, and the constructs a new back span.

abutment. The span length for the new span is approximately 60 feet between centerline of bearings.

With a limited ROW to the south of the bridge, a soldier pile and lagging system is proposed for the new abutment. The soldier pile and lagging will double as the temporary support of excavation system and then become incorporated into the final foundation structure. After installation of the piles, lagging installation and excavation, a new bridge seat and integral concrete façade will be constructed. This substructure type will keep the construction within the ROW and should minimize construction impacts to nearby structures.

The existing abutment bridge seat and back wall will be removed and rebuilt to support the new span. To do this a temporary shoring system will be installed to support the existing span. Frost protection measures (if needed) will be installed.

The construction of a CP-PL 2 Barrier and Modified Type I Protective Screen is proposed to match the concrete encased thru-girders on the existing span.

Utilities are located on a separate utility bridge just south of the roadway bridge. The utility bridge will be retained, but a support pier and end bent will be removed and replaced in a revised location that provides adequate clearances for the relocated tracks and community path. If needed, the utility support girders will be modified to meet code requirements.



ATC 36 allows relocation of the Community Path from track level to street level at the Medford Street Bridge. In doing this, the proposed underpass span length has been shortened by approximately 24 feet, pulling the proposed abutment further away from the right-of-way and nearby structures. Raising the Community Path allows a reduction in beam size thereby increasing vertical clearance above the track.

Raising the Community Path greatly enhances the user experience, by eliminating a long and narrow tunnel like section below the bridge. The relocated path provides another connection to the local road system, as well as a direct connection to the station.

To implement this ATC, the Community Path will connect with Medford Street just south of the proposed underpass span. The path approaching the bridge from the west will be constructed on fill behind new retaining walls and will have a direct connection to the station. A pedestrian viaduct similar to the proposed Community Path Viaduct at the School Street Bridge will bring the path back down to track level on the easterly side.

Construction of a Pedestrian Underpass Behind the Abutment of the School Street Bridge. Our approach to modifying the existing School Street Bridge entails retention of the existing superstructure, replacement of the south abutment and the construction of a new back span and abutment. A single track of the Green Line (MB-WB) will pass below the new span.

The new span will provide a 6' – 3" sidewalk and a 16' – 0" travel lane in each direction, matching the existing cross section. The existing 73' – 6" span is composed of adjacent prestressed concrete box beams with a concrete deck and integral concrete wearing surface. The bridge was designed for an HS-20 loading and the proposed work will not reduce the current capacity of the bridge. The new back span will be designed for an HL-93 loading and constructed of separated prestressed concrete box beams with a concrete deck and integral concrete wearing surface.

With a limited ROW to the south of the bridge, a soldier pile and lagging system is proposed for the new abutment. The soldier pile and lagging will double as the temporary support of excavation system and then become incorporated into the final foundation structure. After installation of the piles, lagging and excavation, a new bridge seat and integral concrete façade will be constructed. This substructure type will keep the construction within the ROW and should minimize/eliminate any construction impacts to several nearby structures.

The existing granite abutment will be removed and replaced with a reinforced concrete pier (columns and pier cap) supported on a reinforced concrete spread footing. To construct the pier, a temporary shoring system will be installed to support the existing span.

The construction of a CP-PL 2 Barrier and Modified Type I Protective Screen is proposed to match the existing span, however an S3-TL4 Bridge Rail can be used if preferred by the Authority.

There is a temporary utility bridge located atop the easterly sidewalk and a temporary pedestrian/utility bridge, located adjacent to the easterly side of the roadway bridge. Utilities carried by these bridges will be relocated back onto the reconstructed roadway bridge. Both temporary structures will be removed and the bridge and approach sidewalk areas will be repaired.

The Community Path crosses School Street and intersects at the northwest and southeast corners of the bridge. Due to a limited ROW, an elevated pedestrian viaduct will be designed to abut the northwest corner of the bridge and an opening will be made in the existing bridge railing for path access. Similar path access will be provided at the southeast corner, although the abutting path may either be on fill behind a new wall or an elevated viaduct similar to the other corner.

Demolition and Reconstruction of the Southeast Wingwall of the Cedar Street Bridge. Our approach to modifying the existing Cedar Street Bridge entails retention of the existing superstructure and modification to the South abutment and wingwall. The substructure modifications will provide horizontal clearance for the Green Line (MB-WB).

Refuge/Safety niches will be installed in the southerly abutment at a maximum spacing of 20' – 0". At niche locations, existing concrete will be removed to specified limits with the new reinforced concrete doweled in to the existing. The southeast wing wall will be removed and replaced

The bridge was built in 1999 and designed for an HS-20 loading. The proposed work will not impact the current load capacity of the bridge. Construction will be performed with minimal impacts to pedestrian and vehicle traffic.

Removing the South Stone Masonry Abutment of the Lowell Street Bridge. Our approach to modifying the existing Lowell Street Bridge entails retention of the existing superstructure and modification to the south abutment to provide horizontal clearance for the Green Line (MB-WB).

The south abutment on the current bridge is constructed with drilled shafts and a reinforced concrete abutment cap/bridge seat. A granite abutment from an earlier bridge is located in front of the drilled shaft abutment and retains the fill below the abutment cap but does not provide any vertical support for the bridge. The granite abutment will be removed for rail clearances and a new soil nail wall system will be installed adjacent to the drilled shafts and designed to support the lateral loads.

The bridge was built in 2006 and designed for an MS22.5 loading. The proposed work will not impact the current load capacity of the bridge. Construction will be performed with minimal impacts to pedestrian and vehicle traffic.

Demolition of the Existing Broadway Bridge and Reconstruction of a New Bridge. Our approach for the Broadway Bridge is to demolish the existing single span bridge and construct a new two span bridge. The new bridge will provide a 5' – 0" bicycle lane and a 12' – 0" travel lane in each direction, an 8' – 8" northerly sidewalk and a 7' – 6" southerly sidewalk. S3-TL4 Bridge Railings and modified Type I Protective Screen will be installed on both sides.

The superstructure for the new bridge will consist of six longitudinal rolled stringers that act compositely with the reinforced concrete deck slab. The deck slab will have an integral concrete wearing surface. Weathering steel will be used, with the ends of the beams either encased in concrete or coated to provide corrosion protection. Stringers will be continuous to eliminate the need for a joint over the pier. Due to the high skew angle, strip seal joints will be used at both abutments.

The easterly abutment will be a full height cantilevered abutment with the footing supported by drilled shafts. The center pier will consist of concrete columns and a concrete cap with the footing supported by drilled shafts. The westerly abutment will be located behind an MSE wall which will be constructed beyond the clear zone for the MB-EB track. The perched westerly abutment will consist of a solid reinforced concrete stem and footing supported by drilled shafts.

A separate utility bridge supports several utilities and is adjacent to the southerly side of the bridge. This bridge will be retained, and painted. The soldier pile and lagging wall at the utility bridge will be modified and coordinated with the approach retaining wall construction along the ROW.

Removal of the Sidewalk on the North Side of the College Avenue Bridge and Construction of New Right-Turn Lane. Our approach to modifying the existing College Avenue Bridge entails retention of the existing superstructure, modification to the northerly sidewalk and construction of a pedestrian bridge just north of the existing bridge and utility bridge.

The existing 5' – 0" northerly sidewalk will be removed to provide a right hand turning lane on the bridge. The sidewalk will be replaced with a safety curb dowelled into the existing prestressed box beams. An S3-TL4 Bridge Railing and modified Type I Protective Screen will be installed. The bituminous concrete wearing surface and waterproofing membrane will be removed and replaced across the entire structure and new sawed and sealed joints will be installed. New endposts will be installed at the ends of the bridge.

Constructing a New Pedestrian/Bike Bridge over the Tracks by the MWRA Utility Support. To compensate for removal of the northerly sidewalk, a new pedestrian bridge will be constructed. The bridge will be a prefabricated truss structure with a span of 95' – 0". The pedestrian bridge will have a 12' – 0" wide concrete wearing surface. Approaches to the pedestrian bridge consist of ramps that tie back in to the approach sidewalk on either end of the roadway bridge. These ramps will meet all ADA slope and accessibility requirements. MSE Walls will be used in the construction of the approach ramps.

Plan, Cross Sections, and Elevations Showing the Structural Form and Design Interpretation

Bridge sketch plans/preliminary plans are included at the end of this section.

4.2.C GEOTECHNICAL ENGINEERING

GLX Constructors' Geotechnical Design Discipline Lead, Bob Palermo, P.E., has 40 years of experience with foundation construction and has extensive knowledge of the ground conditions and engineering properties of the soil and bedrock in the greater Boston area. During the Proposal phase, Bob was involved in all geotechnical aspects of the work and is an integral part of GLX Constructors. He has worked closely with structural engineers on the project team on foundation and retaining wall design. During construction, he will remain involved to assure the design criteria established during final design are properly implemented.

Summary of the Identified Geotechnical Conditions, Constraints, Concerns, and Outstanding Issues

The ground conditions depicted on these figures are based primarily on borings conducted along the proposed track alignment. However, at the northern end of the alignment, the track level is depressed relative to the ground on either side over most of its length because the current track bed was constructed by excavation. Therefore, the conditions described below for the northern portion of the alignment do not necessarily reflect the actual conditions along the proposed retaining walls or

outside the project ROW. To understand the ground conditions at the retaining wall and noise wall locations, transverse sections were developed where there was boring information at the top of slope adjacent to the alignment. This information was used as a basis to develop design soil profiles along each of the retaining and noise walls.

The project can be broken down into four basic areas in terms of ground conditions:

1. **Lechmere/Medford Branch Viaduct (STA 178+00 to STA 223+00).** The southern end of this section is characterized by a relatively thick layer of competent soils consisting of relatively dense sand/silty sand, glaciomarine and glacial till overlying a thin layer of weathered bedrock. Whereas, at the northern end, ground conditions consist of a thinner layer of glacial till overlying a weathered bedrock up to about 90 feet in thickness. A layer of organics and clay was encountered between Piers 1 and 8 and between Piers 19 and 27.
2. **Medford Branch Track (STA 223+00 to STA 374+00).** North of the Medford Branch Viaduct, ground conditions along the track bed generally consist of a thin layer of fill overlying relatively dense glacial till. Bedrock varies from about 50 feet below existing grade to just a few feet below grade. It should be noted that about 2/3 of this section is in an area that required excavation of existing soils during original construction. Therefore, the profiles along the bottom of the trackway do not represent the ground conditions along the proposed retaining wall and noise walls. In order to assess ground conditions along the walls, subsurface profiles along the wall alignments were developed based on the borings taken from the top of slope on either side of the trench. The profiles included in the drawings indicate that glacial till is higher than indicated on the track profiles, and that bedrock is occasionally above the existing elevation of the track ballast.
3. **Union Square Track (STA US WB 3+00 to STA 39+00).** East of approximately STA 10+00, ground conditions generally consist of up to 10 feet of fill overlying medium dense to very dense sandy soils and/or glacial till. A layer of weathered bedrock varying in thickness from about 10 to 60 feet thick was encountered below a relatively thin layer of glacial till between approximately Elevations -10 and -40 feet. The top of bedrock is highly erratic, based on the available borings. West of STA 10+00, the subsurface profile consists of 10 to 15 feet of fill overlying a silty clay layer up to 30 feet thick. A discontinuous layer of organic soils up to 14 feet thick was encountered below the fill along this section of the alignment, including the Union Station area. The silty clay layer is underlain by a glacial till deposit that is generally about 10 feet thick. However, between STA 13+00 and STA 18+00, the glacial till is up to 35 feet in thickness. The glacial till is underlain by weathered bedrock, where it was penetrated by the borings.

4. **Vehicle Maintenance Facility and Yard.** Subsurface conditions generally consist of fill underlain by sand, clay, glacial till, weathered rock and bedrock. Organic soils were encountered in borings performed to the east of the existing tracks, outside of the proposed VMF facility. The top of glacial till/weathered rock/bedrock is typically less than about 40 feet below existing grade. It is also noted that only three borings were performed within the footprint of the proposed VMF building. Therefore, additional borings will need to be performed during final design to better characterize ground conditions within the building footprint.

Constraints and Concerns. Based on our review of the available subsurface information provided, we have identified the following constraints and concerns will need to be considered during final design:

- ▶ There is limited subsurface information along many of the retaining walls. Therefore, conservative assumptions were made to advance the retaining wall design currently shown on the Plans. For example, bedrock may be encountered at a higher elevation than currently anticipated, thus requiring additional bedrock drilling for retaining wall and noise wall piles.
- ▶ The quality of the bedrock is not well defined. Many of the recent borings were advanced in the bedrock without rock coring and associated laboratory testing. At boring location NVB-24, three borings were performed (i.e. NVB-24A, NVB-24B and NVB-24C). One of these borings indicated that the borehole was advanced using a roller bit, while relatively good quality bedrock was cored in the other two adjacent boreholes. This was also the general location of where the O-cell test was performed by the previous contractor on a drilled shaft.
- ▶ None of the rock cores from borings performed by Parsons Brinckerhoff (PB) were available for our designers to review.
- ▶ There is limited information available regarding the existing buildings along the alignment. The condition of the 13 existing buildings that are located within our preliminary zone of influence are of particular concern, since mitigating measures required to protect these structures may be underestimated. Also, the nature and condition of buildings between Station MB 192 and MB 199 are unknown.
- ▶ The existing fill at the south end of the alignment is expected to contain numerous obstructions and few test pits are included in the RFP documents.

Outstanding Issues

- ▶ No long-term monitoring data available on groundwater levels.
- ▶ No Foundation information for the existing buildings where the VMF will be constructed.
- ▶ The soil/rock classification included on the boring logs provided with the RFP appears to be inconsistent between the various geotechnical engineers.

- ▶ The bedrock elevation appears to slope from one side of the alignment to the other. However, often there is little information provided to reliably determine the actual top of rock along both sides of the trackway, due to the limited number of borings. In some areas, the borings along the track bed indicated that the top of bedrock is within a few feet of the ground surface. However, without boring along both sides of the alignment, it is not clear whether the rock was removed to that level or it is the naturally occurring rock level.
- ▶ As shown in Figure 4.2-19, the quality of the bedrock appears to be highly variable and erratic, especially in the area of the Viaduct. Thus, the design of drilled shaft foundations will be difficult, and will need to be conservative to account for the variability in ground conditions

Interpretation of the Geotechnical and Hydrogeological Conditions

The anticipated general ground conditions along the alignment are described in Section 4.2.C. However, to better understand the ground conditions at the retaining wall and noise wall locations, transverse sections were developed where there was boring information at the top of slope adjacent to the alignment. This information was used as a basis to develop design soil profiles along each of the retaining and noise walls. Soil profiles were also developed at each station and bridge location.

Due to access limitations, borings were not performed along the actual retaining and noise wall locations. Therefore, supplemental explorations will be required during final design to confirm the assumption made during the preliminary design that is currently depicted on the drawings and described herein.

Summary of Geotechnical and Hydrogeological Design Properties

Geotechnical design parameters were developed based on the information contained on the boring logs and the laboratory results included in the RFP documents for the preliminary design of the retaining walls and foundations shown on the structural drawings. Our team's extensive experience with the design of similar retaining structures and foundations on local projects such as the Central Artery/Tunnel project, the Wynn Casio and the MBTA North Station Project was also considered in developing these design parameters.

The geotechnical parameters used for the design of the soldier pile and lagging retaining walls and the noise walls are contained in Figure 4.2-20. The parameters for the fill are relative only to the existing fill material, which varies in consistency and density. The friction angle was intentionally selected as conservative, subject to completion of supplemental explorations during final design. For the design of gravity retaining structures and MSE walls, a friction angle of 34 degrees will be used for compacted structural fill.

The soil and bedrock parameters used for the design of the drilled shaft and micropile foundations are shown on the drawings for the Viaduct and the bridge foundations and are included in Table 2. These parameters are based in large part on the local experience of our Geotechnical Design Discipline Lead, Bob Palermo, on projects



Figure 4.2-19. Variability in Bedrock quality. These photographs demonstrate the extreme variability of the quality of the bedrock. The photo on the left shows competent rock core, and the photo on the right is a sample of rock that was obtained with a standard split spoon soil sampling device.

such as the Central Artery/Tunnel project, the New Boston Garden, and the new Wynn Boston Casino. We also reviewed the results of four load tests for drilled shafts socketed into bedrock performed at the Woods Memorial Bridge in Medford, Massachusetts.

During preliminary design, we conservatively ignored the contribution of the soils overlying the glacial till stratum, including the relatively thick sand layer between approximately STA 191+00 and 201+00. We will revisit this assumption during final design.

The depth of the drilled shafts shown on the drawings are based primarily on static loading conditions. Some of the shaft depths are actually deeper than required based on the geotechnical parameters to take into account the effect of seismic loads that were only estimated during preliminary design. A more rigorous seismic analysis will be performed during final design that may result in shorter shaft lengths, particularly for Piers 32 through 37, where the required embedment for axial load support is relatively small.

Outline of Additional Geotechnical Investigations, Laboratory Testing, and Analyses

We have developed a preliminary program of supplemental subsurface explorations and laboratory testing that will be performed immediately after NTP. The exploration program will be performed in phases consistent with the final design and construction schedule. Based on the results of these explorations, the preliminary program described herein may be modified to reflect the actual ground conditions encountered.

Supplemental Geotechnical Investigations. Supplemental explorations will be performed to confirm the quality of the information indicated on the available exploration logs, and to satisfy the Project requirements for the minimum number of borings described in Table 15.1-2 of the Technical Provisions. Confirmatory borings are primarily anticipated to be required in portions of the alignment where current subsurface information is not available, and in areas of thick weathered rock where deep foundations with rock sockets are proposed along the Medford and Union Square viaducts. These supplemental explorations will be observed and logged by GLX Constructors.

Preliminary Design Soil Properties					
Soil Starta	Total Unit Weight (pcf)	Submerged Unit Weight - (pcf)	Friction Angle - degrees	Uniaxial Compressive strength (psi)	Conhesion (psf)
Fill	125	63	30	-	-
Sand	128	66	32	-	-
Till	135	73	39	-	-
WRx	135	73	0	-	4,000
Rx	155	-	-	3,500	-

Figure 4.2-20. Preliminary Design Soil Properties. Preliminary Geotechnical Design Parameters for Soldier Pile Walls and Noise Walls.

Figure 4.2-21 summarizes the required minimum number of boring required, and indicates the number of supplemental explorations that we will perform.

At the viaduct pier and abutment locations, one supplemental boring will be performed at each drilled shaft location. At Piers 1 through 7, which will be supported on micropiles due to limited overhead clearance below the existing viaduct, two borings will be performed at each pier to confirm rock quality for the rock socketed portion of the micropiles. At locations of previously constructed viaduct foundations at Piers 26 and 27, one boring will be performed at each shaft location to confirm subsurface conditions needed to validate the design of the as-built drilled shaft foundations. Also, in order to

Geotechnical Feature	Minimum Number of Total Borings	Minimum Number of Supplemental Borings Required	Number of Supplemental Explorations to be Performed
Track Subgrade	In accordance with AREMA	Not Specified	0
Vehicle Maintenance Facility	8 within Footprint	6	8
Stations	6 per station	0	7
Viaduct Piers and Abutments	1 at each caisson and each abutment	26	26
Bridge Piers and Abutments	In accordance with AASHTO and the MassDOT LRFD Bridge Manual	2	12
Retaining Walls and Noise Barriers	2 at each retaining wall and noise barrier. Max. spacing of 200 feet between borings.	20 for Noise Walls 21 for Retaining Walls	20 for Noise Walls 29 for Retaining Walls
Traction Power Substations and other Ancillary structures	As required by applicable code.	0	4
Embankments and Cuts	In accordance with FHWA NHI-01-031 Subsurface Explorations – Geotechnical Site Characterization	0	4
Micropiles at Piers 1 – 7	Not Specified	N/A	14
Previously Completed Drilled Shafts and Osterberg Test Shaft Locations	Not Specified	N/A	7
	Total	75	131

Figure 4.2-21. Proposed Supplemental Explorations. Our exploration program will meet or exceed the required minimum number of explorations specified.

evaluate the results drilled shaft load test performed by the previous contractor, one boring will be performed at the location of the Osterberg test shaft location.

Confirmatory borings will be performed at retaining and noise wall locations in order to evaluate the top of rock variability (i.e., potential sloping bedrock surface) and to confirm required foundation lengths. We will perform more borings than the minimum number specified, because many of the existing borings provide the information needed for design.

Two confirmatory borings will be performed at each of the Ball Square and Gilman Square Station traction power substations.

In addition, borings will be performed as needed to evaluate soil and rock conditions along areas of proposed utilities, drainage structures and OCS foundations. The supplemental boring information will be used to evaluate if shallow weathered rock and bedrock will be able to be removed using conventional earth moving equipment.

In addition to the boring identified in Figure 4.2-21, we will perform refraction tomography testing to evaluate the quality and rippability of the bedrock along the proposed 66-inch drain line at the north end of the project where the bedrock is relatively shallow. The assessment of the rippability of bedrock will be based on the bedrock compressional wave velocity.

Laboratory Testing. Additional laboratory testing will consist primarily of unconfined compression tests to evaluate the strength and elastic modulus of the bedrock for the design of drilled shafts. Between approximately STA 200 and 223, the available borings indicate that the weathered bedrock is up to about 90 feet in thickness. Many of the reference geotechnical reports included in the RFI documents indicate a relatively low skin friction value. We believe that the strength of this material is understated, and we expect that the additional laboratory testing will justify higher skin friction values that will result in shorter drilled shaft lengths. Additional tests in the area of the O-cell test on the drilled shaft will allow us to better evaluate the results of the load test, and extrapolate these results to other production shafts.

Laboratory strength tests will also be performed on samples of weathered bedrock and bedrock at the north end on the alignment, where this material may be encountered during installation of the 66-inch drain line. Here, the purpose of the testing is to evaluate methods of rock removal.

Preliminary Hydrogeological Impact and Associated Risk Assessment

Depending on the duration, depression of the groundwater level outside of excavations will generally result in settlement of structures and utilities if there are compressible soils such as clay and organic soils. However, these soils only exist south of the yard lead crossing (STA 208+00), at the Vehicle Maintenance Facility and Yard, and along the Union Branch alignment.

At the northern end of the alignment, excavations are required for stations, utility installation and retaining wall construction. There are no compressible soils that will result in ground movements, even if the groundwater was depressed for an extended period. The soils in this area that overly the bedrock consist of dense glacial till soils that are relatively incompressible and impervious thus limited the zone of influence of depressed groundwater levels.

Anticipated Soil Groundwater Control Strategy for the Construction Period. Except for the installation of the 66-inch drain and other smaller diameter/shallower utilities along the alignment, excavation associated with new track construction or retaining wall construction will not be required below the bottom of the existing sub ballast. Much of the excavation for drainage and utilities will be less than 4 feet deep, and above the measured groundwater level, in areas where compressible soils are anticipated.

The excavation for the 66-inch drain is about 15 feet below existing grade, and about 5 feet below the groundwater level. The soils in this area of the alignment consist of granular fill and very dense glacial till, and are not subject to compression due to groundwater lowering, even if it did occur.

Construction dewatering is expected to be accomplished with conventional sump pumps, during relatively short durations. Therefore, there is no adverse impact associated with construction.

Anticipated Groundwater Control Strategy for all Subsurface Excavations. Groundwater levels will not be lowered below existing levels, since the finish grades will not be lower that they are now. However, as a mitigation measure, seepage collars will be constructed at approximately 200-foot intervals along deep utilities that run along the alignment to mitigate the potential for drainage. At each location, the trench excavation will be backfilled with a 2 to 4-foot wide zone of low permeability material that will serve as a dam that isolate each segment of trench between the seepage collars.

Preliminary Geotechnical Impact Assessment and Associated Risks

The Zone of Influence reference in the Contract Documents is only defined for establishing the number of structures where preconstruction condition surveys are required to be performed. Therefore, a preliminary Zone of Influence has been established as a basis to evaluate the probable limits of potential impacts to adjacent structures due to retaining wall construction. Our preliminary Zone of influence is based on a 1.5H:1V line extending from the bottom of excavation at the retaining wall to the 4 feet below grade outside the excavation and is shown on the retaining wall drawings. This is based primarily on published empirical correlations of ground movement and estimated wall deflections from the structural design of the retaining walls. Finite element analyses have also been performed that suggest that, for the ground conditions along the retaining walls the Zone of Influence shown on the drawings actually extend

further away from the walls than required. This is also more conservative than the Zone of Influence specified for the preconstruction condition surveys. The Zone of Influence that we have used during preliminary design is shown on the individual retaining wall profile drawings.

Based on our preliminary, conservative limits of the Zone of Influence, there are 13 buildings that could be impacted by proposed construction. The primary impact of this conservative approach is that the retaining walls in front of these structures will be more conservatively designed to resist seismic loads. The depth of the foundation of the existing buildings was assumed to be only 4 feet below existing grade. If there are basements, the Zone of Influence will be further reduced.

A preliminary assessment of all buildings within the Zone of Influence have been performed based on the information currently available.

Where the estimated ground movements were expected to result in more than “cosmetic” damage, as described by Burland et al. 1977 and Borcardin and Cording, 1989, the stiffness of the retaining wall was increased to reduce ground movements to acceptable levels. This was accomplished either by using heavier soldier pile sections, reducing the spacing of soldier piles, increasing the embedment depth of the piles or providing a tieback near the top of the soldier pile. If measures movements exceed those anticipated during design and appear to impact adjacent structures, larger soldier pile sections will be used, or piles will be installed at closer spacings.

Our Geotechnical Design Discipline Lead has performed similar impact assessments on major urban construction projects such as the Central Artery/Tunnel project in Boston, the Second Avenue Subway Project in NYC.

An automated geotechnical instrumentation monitoring program will be used to monitor retaining wall movements on a near real time basis during and after construction. Monitoring prisms will be established on permanent soldier piles at spacing of not more than 24 feet. If allowed by building Owners, monitoring prisms will also be established on the 13 buildings that fall within the Zone of Influence. A dedicated website will be established to store and display automated monitoring results.

Tracks and other structures will be monitored manually by surveyors in accordance with the project requirements.

Vibrations will be monitored during pile driving at Piers 8 through 24. We will also monitor vibrations periodically during drilling of soldier piles and soil compaction to confirm that these activities do not result in excessive vibrations at adjacent structures.

“**To reduce the number of explorations and increase the efficiency of the supplemental exploration program, geotechnical and environmental sampling locations will be coordinated by our team to reduce impacts to the surrounding communities and active train traffic.**”

“**The proposed monitoring program has been successfully implemented on the Tappan Zee Bridge Replacement Project to monitor the impacts of pile installation for the new bridge on the existing adjacent, and is accessible to all project participants.**”

GLX Constructor's approach is to provide simple structures that are straightforward to install and accelerate construction. The structures will be designed to meet the structural design life expectations and simplify future maintenance.

ITP Request	RFP		
	Drawing Number	Drawing Title	Reference Section or Drawing
A5.2.2.A.2	S-001	Soldier Pile and Lagging Wall Elevation, Section and Details	
A5.2.2.A.2	S-002	MSE Wall Elevation, Section and Details	
A5.2.2.A.2	S-003	Modular Precast Block Wall Elevation, Section and Details	
A5.2.2.A.2	S-004	Cast in Place Concrete Wall Elevation, Section and Details	
A5.2.2.A.2	S-005	Soil Nail Wall Section and Details	
A5.2.2.A.2	S-006	Soil Nail Crib Wall Replacement Wall Section and Details	
A5.2.2.A.2	S-007	Soil Nail Wall & Crib Wall Replacement Typical Elevations	
A5.2.2.A.2	S-008	Sheet Pile Wall Elevation, Section and Details	
A5.2.2.A.2	S-009	Noise Barrier Elevation, Section and Details	
A5.2.2.A.2	S-010	Retaining Wall MW-5 Plan and Subsurface Profile	
A5.2.2.A.2	S-011	Retaining Wall MW-10 Plan and Subsurface Profile	
A5.2.2.A.2	S-012	Bumping Post Detail	
A5.2.2.A.2	S-013	Lechmere Viaduct Split Framing Plan, Typical Section, Pier Elevation and Geotech	
A5.2.2.A.2	S-014	Medford Branch Viaduct Framing Plan, Typical Section, Pier Elevation and Geotech	
A5.2.2.A.2	S-015	Union Square Branch Viaduct Framing Plan, Typical Section, Pier Elevation and Geotech	
A5.2.2.A.2	S-016	ATC 35 Mse Plan View	
A5.2.2.A.2	S-017	ATC 35 Typical Section	
A5.2.2.A.2	S-018	ATC 35 Ground Improvement At MSE Walls	
A5.2.2.A.2	S-019	Washington Street Bridge – Plan & Elevation	
A5.2.2.A.2	S-020	Washington Street Bridge – Typical Section	
A5.2.2.A.2	S-021	Medford Street Bridge – Plan and Notes	
A5.2.2.B.3	S-022	Medford Street Bridge – Section and Elevation	
A5.2.2.B.3	S-023	School Street Bridge – Plan and Notes	
A5.2.2.B.3	S-024	School Street Bridge – Elevation	
A5.2.2.B.3	S-025	School Street Bridge – Cross Sections	
A5.2.2.B.3	S-026	Cedar Street Bridge – Plan and Elevation	
A5.2.2.B.3	S-027	Lowell Street Bridge – Plan and General Notes	
A5.2.2.B.3	S-028	Lowell Street Bridge – Elevation	
A5.2.2.B.3	S-029	Broadway Bridge – Plan & Elevation	
A5.2.2.B.3	S-030	Broadway Bridge – Typical Transverse Section	
A5.2.2.B.3	S-031	College Avenue Bridge – Typical Sections	
A5.2.2.B.3	S-032	College Avenue Pedestrian Bridge – General Plan and Elevation	

Technical Solutions Drawing Matrix.

PLOTTED: 08/29/17 9:16PM BY: JAL/ST
 DRAWING: 1. PROPOSAL (GLX) TECH DESIGN RETAINING WALLS-NOISE WALLS_SOLDIER PILE AND LAGGING WALL.DWG [LAYOUT] 08/22

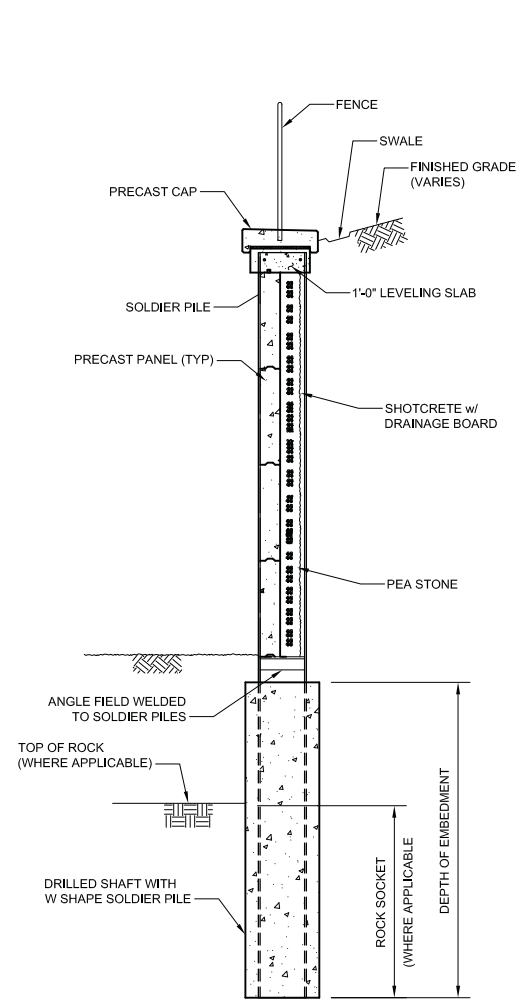

TYPICAL SOLDIER PILE AND LAGGING (SPL) WALL

1/4"=1'-0" 0 2' 4' 8'

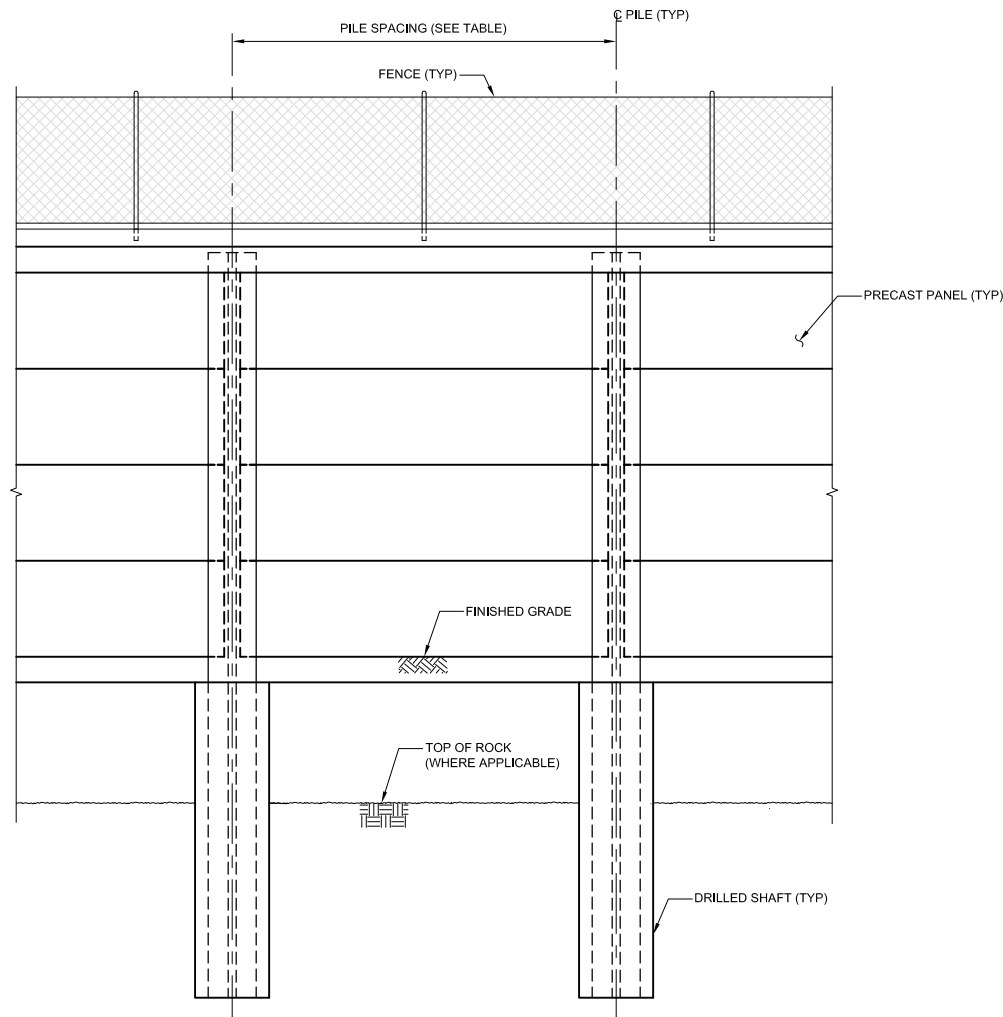

TYPICAL SOLDIER PILE AND LAGGING (SPL) WALL ELEVATION

1/4"=1'-0" 0 2' 4' 8'

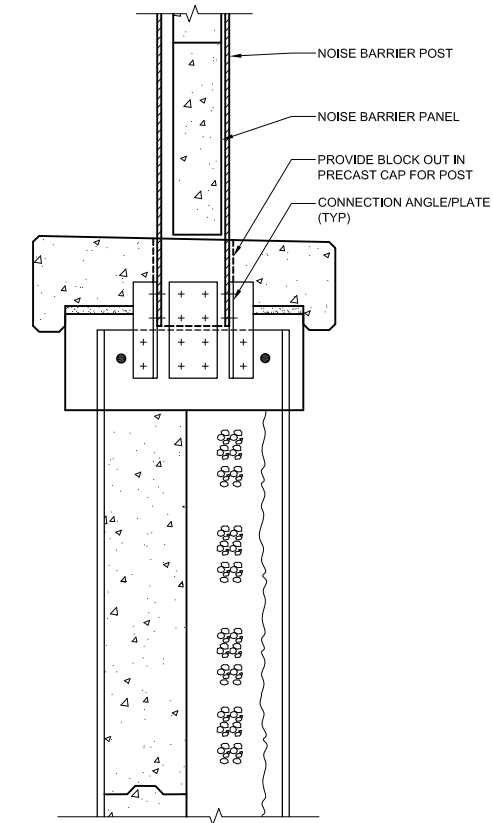

NOISE BARRIER DETAIL

1"=1'-0" 0 1' 2'

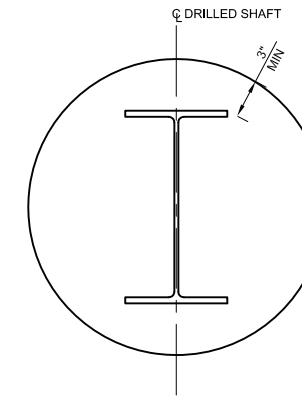

SECTION - SOLDIER PILE WITH DRILLED SHAFT

1"=1'-0" 0 1' 2'

NOTES:

1. CIP CONCRETE SHALL BE F'c = 4,000 psi.
2. PRECAST CONCRETE SHALL BE 5,000 psi.
3. ALL STRUCTURAL STEEL SHALL BE ASTM A572, A709 OR A992 GRADE 50 HOT DIPPED GALVANIZED.
4. REINFORCING STEEL SHALL BE ASTM A615 GRADE 60.

SOLDIER PILE AND LAGGING WALL TABLE													
WALL	STATION		OFFSET (FT) FROM MB-EB	OFFSET (FT) WALL FACE-TEMP EASE	OFFSET (FT) WALL FACE-PERM EASE	PILE SIZE	PILE SPACING (FT)	SHAFT DIAMETER (FT)	EXPOSED FACE (FT)	PILE LENGTH (FT)	SOIL EMBEDMENT (FT)	ROCK SOCKET (FT)	NOTES
	START	END											
ME-1	247+47	248+98	42	10-16	10-16	W24x76	8	3	14	29	15	-	
	309+63	313+00	39-40	3-16	3-16	W21x44	8	3	10	19	5	4	
ME-2	313+00	314+50	39-40	3-10	3-4	W24x68	8	3	12	27	15	-	
	314+50	316+00	39-40	4	4	W21x48	8	3	10	23	13	-	
	316+00	319+50	39-40	4-10	4-10	W21x48	8	3	10	22	9	3	
	319+50	320+50	39-40	10	10	W21x44	8	3	10	23	13	-	
ME-2.1	321+25	323+25	42	12	12	W14x30	8	3	6	15	9	-	
ME-3	223+01	225+50	40-45	15	6	W21x48	8	3	12	20	2	6	STATIONS ARE NH-T1
	225+50	227+50	40-45	15-20	6-20	W24x55	8	3	13	21	2	6	STATIONS ARE NH-T1
	227+50	231+05	40-45	18-20	18-20	W21x44	8	3	9	15	3	3	STATIONS ARE NH-T1
MW-0.7	235+25	235+75	52-61	-	-	W18x35	8	3	9	22	11	2	
MW-0.8	236+25	236+99	52-61	-	-	W18x35	8	3	9	22	11	2	
MW-36.2	258+31	259+50	22	100-150	100-150	W24x84	8	3	13	30	17	-	
	259+50	261+58	22	35-100	35-100	W24x229	8	3	18	42	24	-	TIEBACK MAY BE USED
MW-36.3	262+86	265+00	24	35	29-35	W14x53	8	3	10	23	13	-	
	265+00	266+38	24	35	29-35	W24x104	8	3	15	34	19	-	
MW-36.4	267+94	268+50	34	35	35	W30x261	8	3.5	24	51	14	13	TIEBACK MAY BE USED
	268+50	269+50	34	19-35	19-27	W24x229	8	3	21	45	14	10	TIEBACK MAY BE USED
	269+50	270+78											
	270+94	275+18	34	23-38	23-38	W24x162	8	3	20	41	13	8	
MW-5	276+00	278+00	24-40	14	5-10	W24x279	8	3	24	48	24	-	
	278+00	279+25	24-40	14-16	10-16	W24x94	8	3	12	30	18	-	
MW-7	296+40	298+75	22	10-28	2-10	W24x84	8	3	15	28	5	8	
MW-8.1	327+00	329+75	20-31	8-15	2-5	W16x40	8	3	7	20	13	-	
MW-8.15	331+39	332+39	40	11	11	W24x131	8	3	16	33	9	8	

PROPOSAL

MASSACHUSETTS BAY TRANSPORTATION AUTHORITY



GREEN LINE EXTENSION PROJECT
 MBTA CONTRACT NO. E22CN04
 CAMBRIDGE/SOMERVILLE, MASSACHUSETTS

SOLDIER PILE AND LAGGING WALL ELEVATION, SECTION AND DETAILS



GV20170258-272.pdf

SCALE: AS NOTED	DRAWN BY: []	DESIGN BY: []	CHECK BY: []	PLAN NO.:	ISSUE
DATE: SEPT. 28, 2017	DH	EE	EE	SHEET: S-001	
ISSUE	DATE	DESCRIPTION	BY	CHKD	APP.

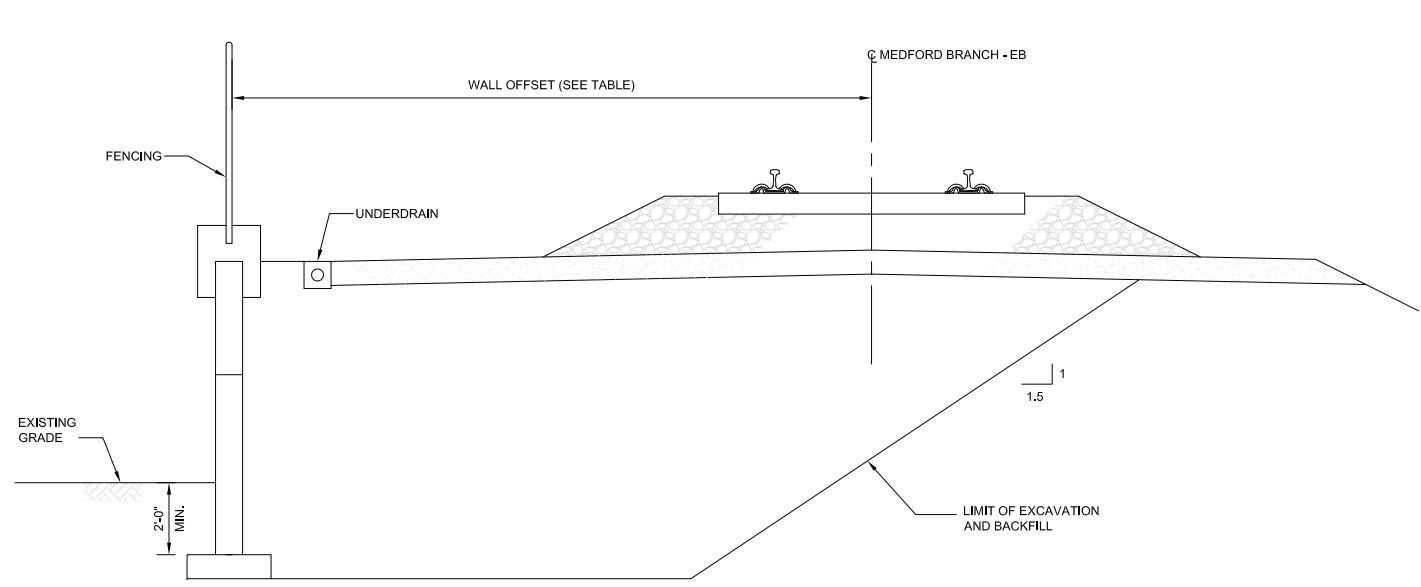

MSE WALL

3/8"=1'-0"
0 2' 4' 6'

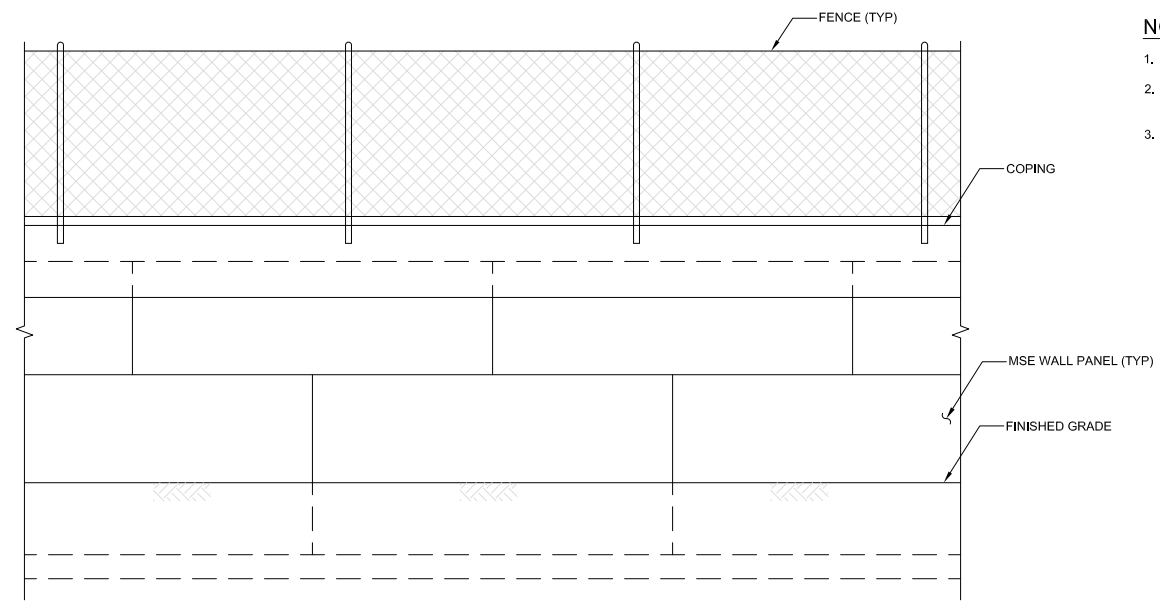

MSE WALL ELEVATION

3/8"=1'-0"
0 2' 4' 6'

- NOTES:**
1. PRECAST CONCRETE SHALL BE 5,000 PSI.
 2. REINFORCING STEEL SHALL BE ASTM A615 GRADE 60.
 3. PROVIDE CANTILEVERED COPING WITH MOMENT SLAB AT TITAN CAR WASH.

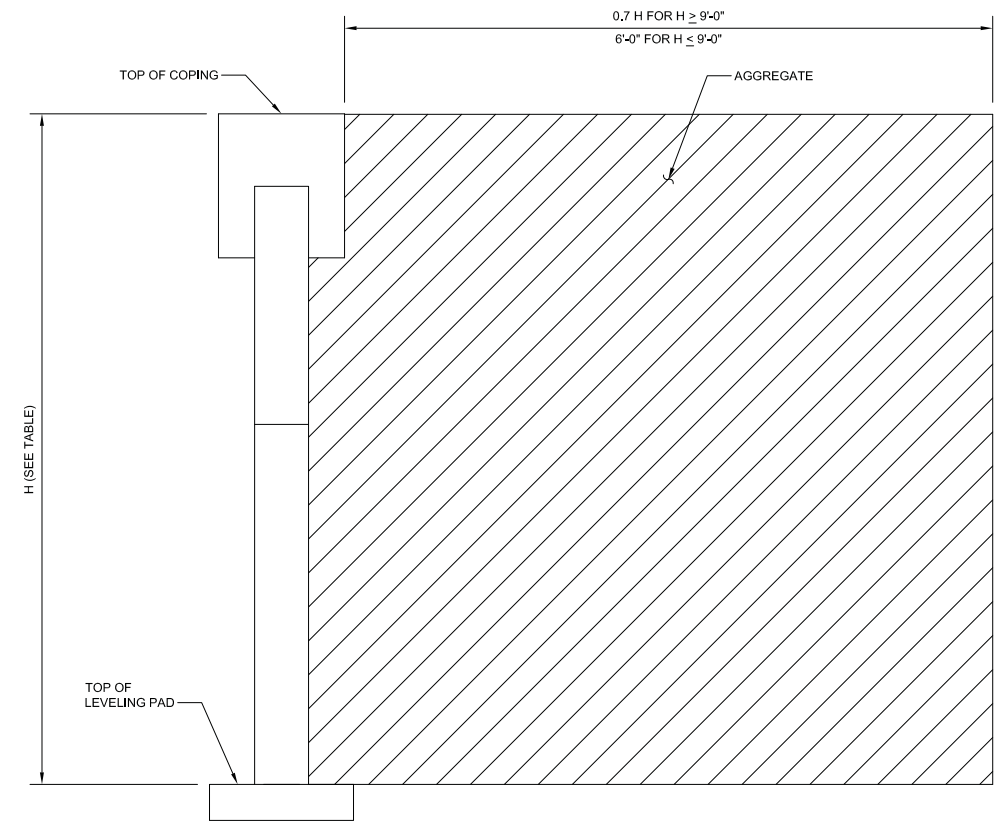

ASSUMED AREA OF REINFORCED ZONE

3/4"=1'-0"
0 1' 2' 3'

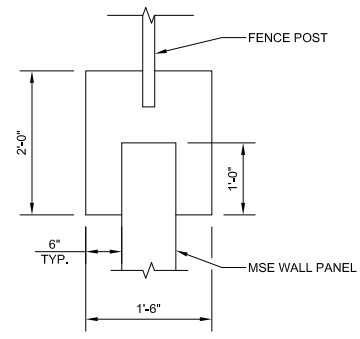

COPING DETAIL

3/4"=1'-0"
0 1' 2' 3'

MSE WALL TABLE					
WALL	STATION		OFFSET	HEIGHT, H (FT)	NOTE
	START	END			
MW-8.2	343+56	345+20	18	13	SEE NOTE 3
MW-9	345+80	348+50	20	8	
	348+50	351+00	20	7	
	351+00	353+54	20	6.25	

PLOTTED: 08/29/17 9:16PM BY: JHAYES
 DRAWING: I:\PROJECTS\GLX\TECH DESIGN\RETAINING WALLS-HOUSE WALLS\PROPOSAL DRAWINGS\S-002 MSE WALL DETAILS.DWG [LAYOUT] 08/21/17 4:32PM

PROPOSAL

MASSACHUSETTS BAY TRANSPORTATION AUTHORITY
 GREEN LINE EXTENSION PROJECT
 MBTA CONTRACT NO. E22CN04
 CAMBRIDGE/SOMERVILLE, MASSACHUSETTS

**MSE WALL
 ELEVATION, SECTION AND DETAILS**

SCALE: AS NOTED	DRAWN BY: DH	DESIGN BY: EE	CHECK BY: BD	PLAN NO.	ISSUE
DATE: SEPT. 28, 2017				SHEET: S-002	

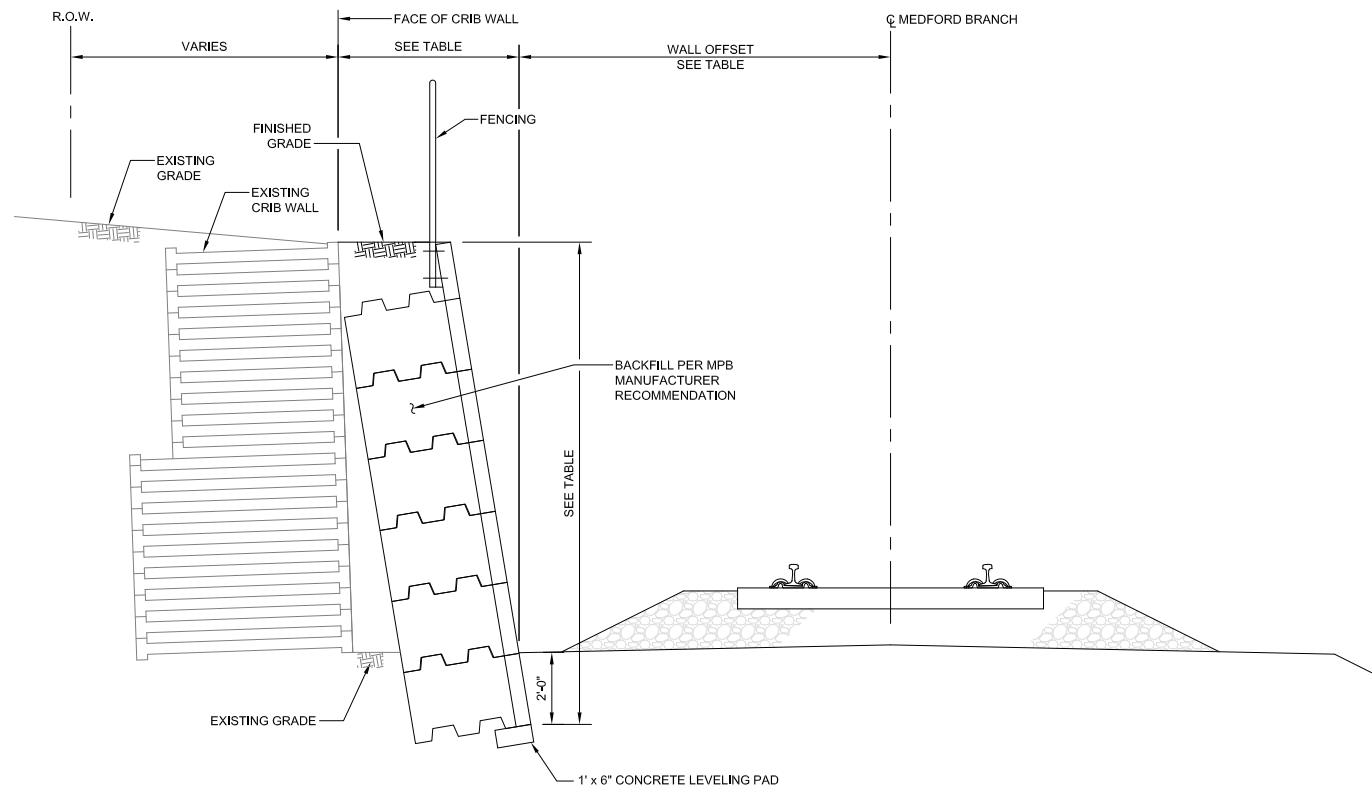

MODULAR PRECAST BLOCK WALL SECTION AT CRIB WALL

MODULAR PRECAST BLOCK WALL AT CRIB WALL TABLE						
WALL	STATION		OFFSET FROM MB-EB (FT)	MINIMUM DISTANCE BETWEEN FACE OF CRIB WALL AND FACE OF MPB WALL	AVERAGE TOTAL HEIGHT (FT)	NOTES
	START	END				
MCE-1	248+97	252+42	38	4.5	11	SEE NOTE 5
MCW-1	247+03	251+28	32	5.5	12	SEE NOTE 5

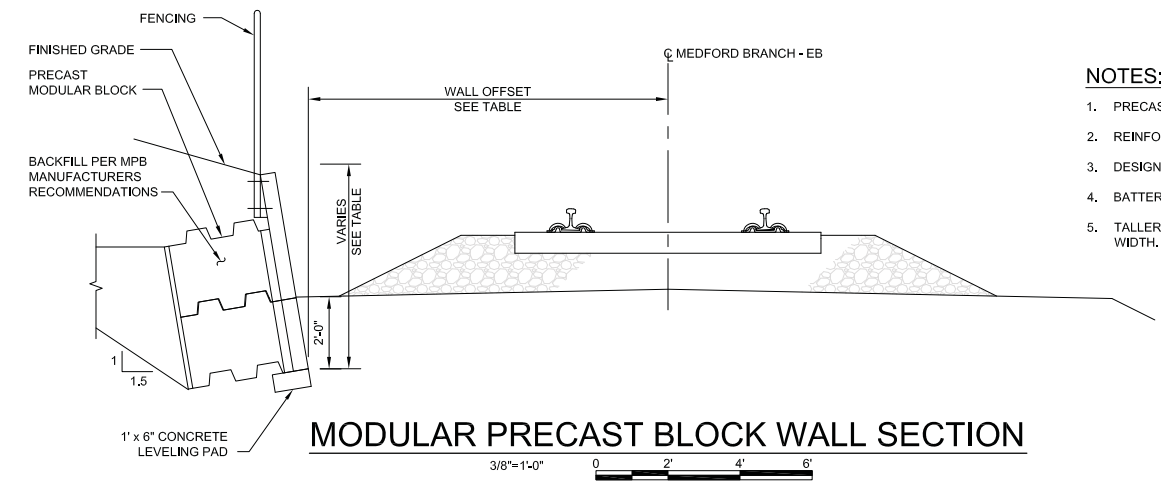

MODULAR PRECAST BLOCK WALL SECTION

MODULAR PRECAST BLOCK WALL TABLE					
WALL	STATION		OFFSET FROM MB-EB	TOTAL HT (FT)	NOTES
	START	END			
ME-0.5	216+49	217+00	30	8	
	217+00	217+53	30	6	
ME-2.2	327+25	327+75	40	7	
ME-2.3	328+25	328+75	40	5	
ME-2.5	363+75	364+25	40	8	
MW-36.1	257+27	258+31	22	7.5	
MW-5.5	279+25	280+75	25	10	
	280+75	281+25	25	8	
MW-6.5	295+75	296+40	23	6	
MW-7.5	298+75	299+75	22	10	
MW-7.6	298+00	299+00	36	6	
	299+00	299+50	36	8	
	299+50	300+50	36	12	SEE NOTE 5
	300+50	301+25	36	6	
MW-8	322+75	323+25	22	4	
	323+25	324+75	22	6	
	324+75	327+00	22	7.5	
MW-9.5	360+75	361+50	22	10	
	361+50	362+00	22	12	SEE NOTE 5
	362+00	362+80	22	15	SEE NOTE 5

- NOTES:**
1. PRECAST CONCRETE SHALL BE 5,000 PSI.
 2. REINFORCING STEEL SHALL BE ASTM A615 GRADE 60.
 3. DESIGN TO BE PERFORMED BY WALL MANUFACTURERS.
 4. BATTER WALL AS REQUIRED BY DESIGN.
 5. TALLER WALL SECTIONS MAY REQUIRE INCREASED BASE WIDTH.

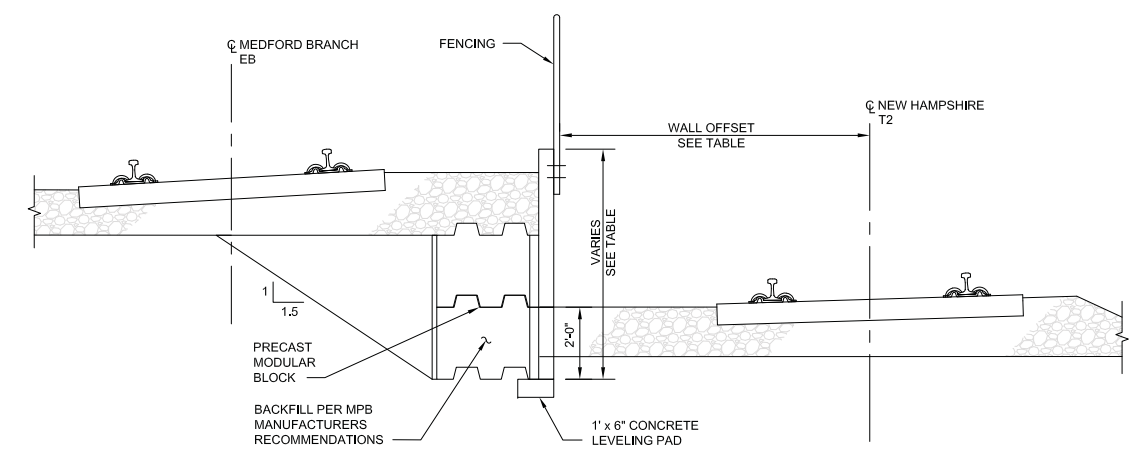

MODULAR PRECAST BLOCK WALL SECTION AT BALLAST RETAINING WALL

MODULAR PRECAST BLOCK WALL AT BALLAST RETAINING WALL TABLE					
WALL	STATION (MB-EB)		OFFSET FROM NH-T2	TOTAL HT (FT)	NOTES
	START	END			
BR-1	261+00	262+50	9	6	
	262+50	268+00	9	7	
	268+00	269+00	9	6	

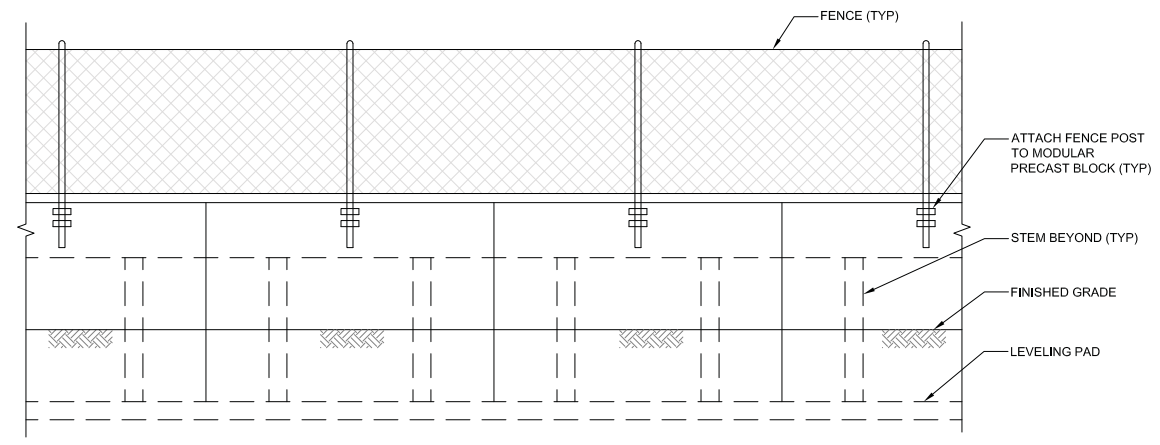

MODULAR PRECAST BLOCK WALL ELEVATION

PROPOSAL

MASSACHUSETTS BAY TRANSPORTATION AUTHORITY
T
 GREEN LINE EXTENSION PROJECT
 MBTA CONTRACT NO. E22CN04
 CAMBRIDGE/SOMERVILLE, MASSACHUSETTS

MODULAR PRECAST BLOCK WALL ELEVATION, SECTION AND DETAILS



GV20170258-272.pdf

SCALE: AS NOTED	DRAWN BY: []	DESIGN BY: []	CHECK BY: []	PLAN NO.:	ISSUE
DATE: SEPT. 28, 2017	DH	EE	EE	SHEET: S-003	[]
ISSUE	DATE	DESCRIPTION	BY	CHKD	APP.

PLOTTED: 08/29/17 9:17PM BY: JAL:RDT
 DRAWING: I:\PROPOSALS\GLX\TECH DESIGN\RETAINING WALLS-HOUSE WALLS\PROPOSAL DRAWINGS\003 MODULAR PRECAST BLOCK WALL.DWG [LAYOUT] 09/22/17

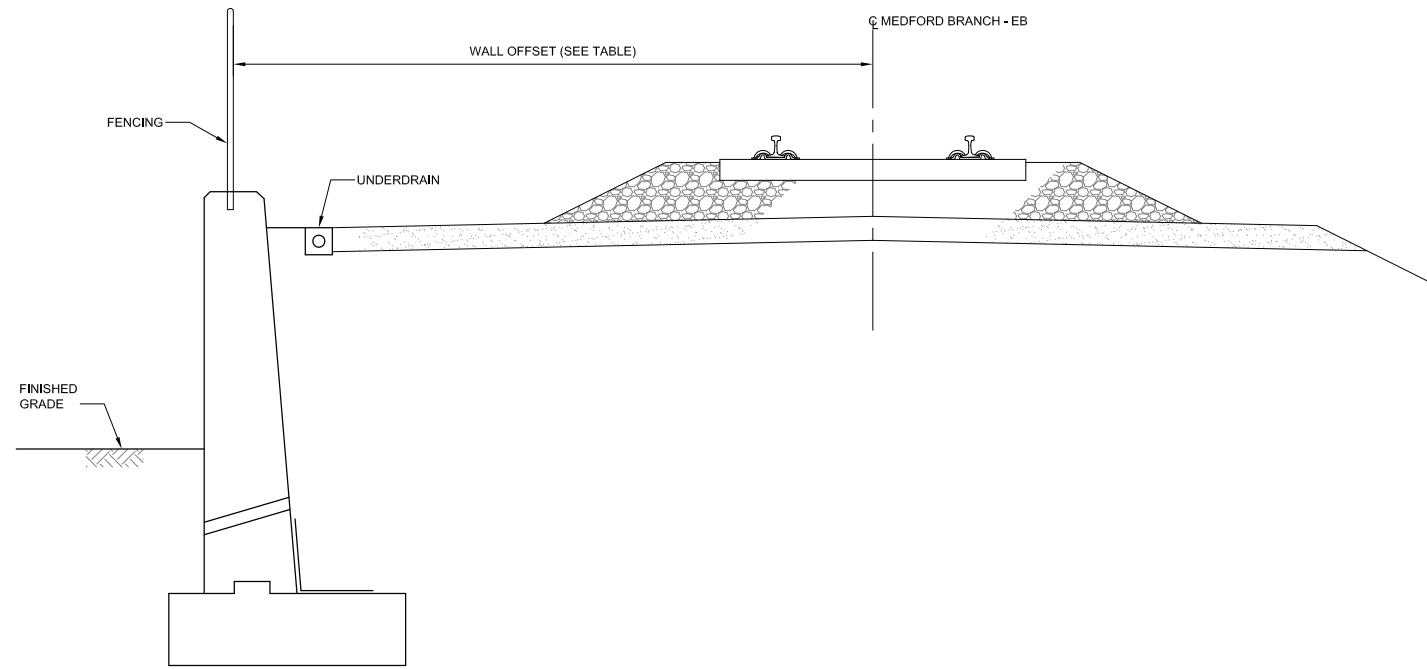

CAST IN PLACE CONCRETE WALL

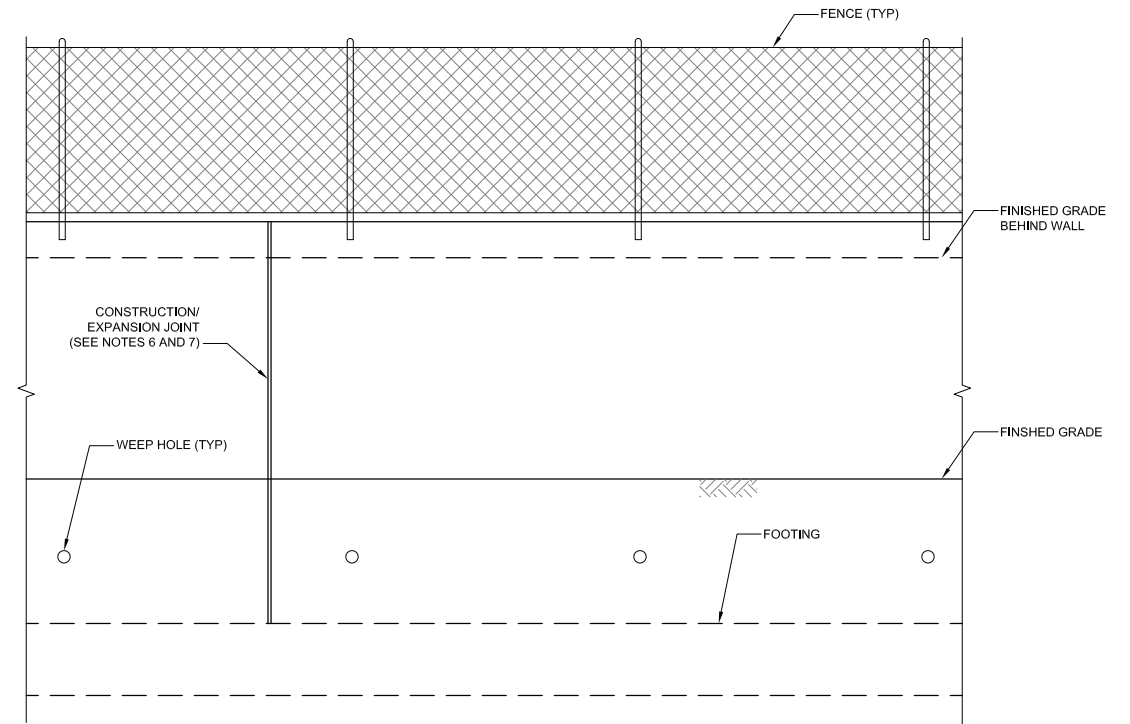

CAST IN PLACE CONCRETE WALL ELEVATION

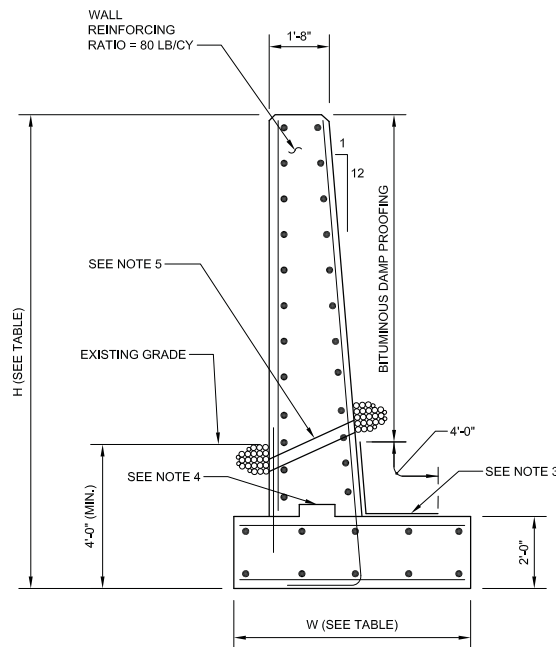

TYPICAL SECTION



WALL	STATION		OFFSET	H, HEIGHT (FT)	W, FOOTING WIDTH (FT)
	START	END			
MW-0,5	234+20	235+50	40	10	6
	235+50	237+03	40	18	10

NOTES:

1. CONCRETE SHALL BE 4,000 PSI.
2. REINFORCING STEEL SHALL BE ASTM A615 GRADE 60.
3. MEMBRANE WATERPROOFING AND CEMENT CONCRETE BLOCKS LAID IN MORTAR.
4. CONSTRUCTION JOINT WITH KEY.
5. 4" DIAMETER WEEP HOLE AT 10' ON CENTER WITH 1" CUBIC YARD CRUSHED STONE AT EACH END OF WEEP HOLE.
6. MAXIMUM CONSTRUCTION JOINT SPACING = 40'-0".
7. MAXIMUM EXPANSION JOINT SPACING = 100'-0".

PROPOSAL

MASSACHUSETTS BAY TRANSPORTATION AUTHORITY

T

GREEN LINE EXTENSION PROJECT
 MBTA CONTRACT NO. E22CN04
 CAMBRIDGE/SOMERVILLE, MASSACHUSETTS

CAST IN PLACE CONCRETE WALL ELEVATION, SECTION AND DETAILS



GV20170258-272.pdf

SCALE: AS NOTED	DRAWN BY: DH	DESIGN BY: ZY	CHECK BY: EE	PLAN NO.	ISSUE
DATE: SEPT. 28, 2017				SHEET: S-004	

PLOTTED: 09/29/17 9:17PM BY: JAVED
 DRAWING: I:\PROPOSALS\GLX\TECH DESIGN\RETAINING WALLS-HOUSE WALLS\PROPOSAL DRAWINGS\S-004_CIP_WALL_DETAILS.DWG [LAYOUT] 09/22/17 10:13AM

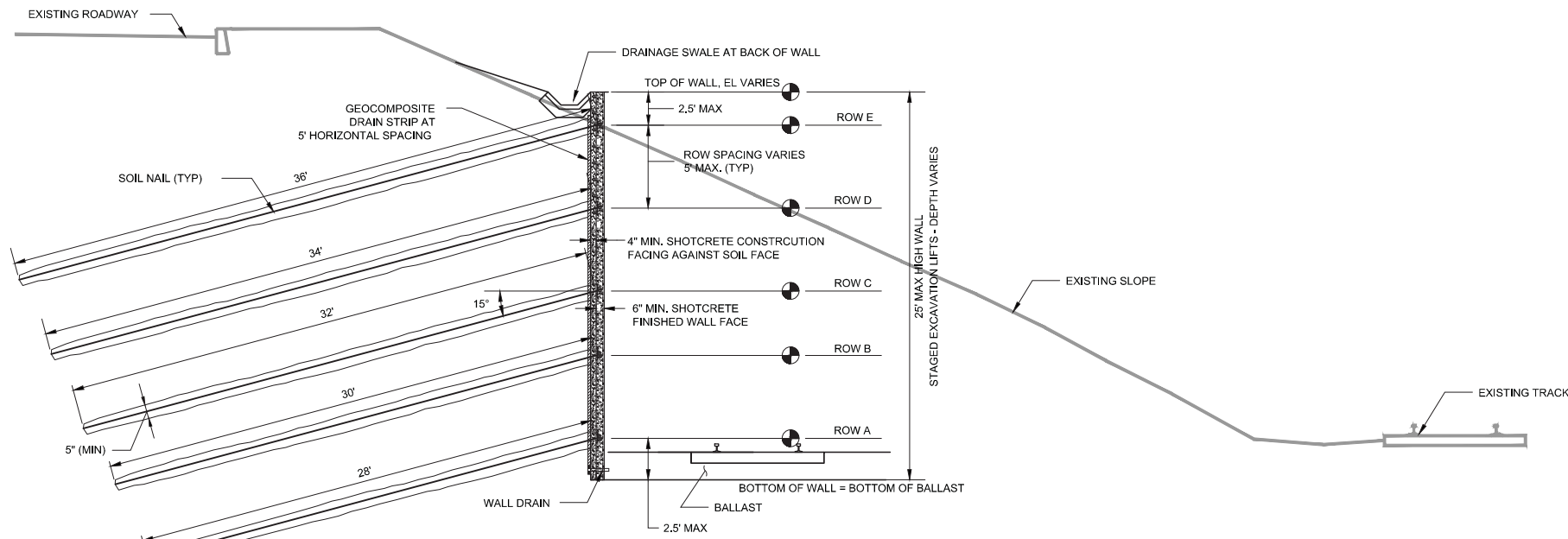

TYPICAL WALL SECTION
NOT TO SCALE

SECTION NUMBER	STATION		NUMBER OF LEVELS	MAXIMUM WALL HEIGHT	LENGTH	QUANTITY
	FROM	TO				
1	374+00	371+82	3	15 FEET	ROW C = 32 FT LONG	44
					ROW B = 30 FT LONG	44
					ROW A = 28 FT LONG	44
2	371+82	369+72	4	20 FEET	ROW D = 34 FT LONG	42
					ROW C = 32 FT LONG	42
					ROW B = 30 FT LONG	42
					ROW A = 28 FT LONG	42
3	369+72	366+67	5	25 FEET	ROW E = 36 FT LONG	62
					ROW D = 34 FT LONG	62
					ROW C = 32 FT LONG	62
					ROW B = 30 FT LONG	62
					ROW A = 28 FT LONG	62
4	364+79	364+12	4	20 FEET	ROW D = 34 FT LONG	13
					ROW C = 32 FT LONG	13
					ROW B = 30 FT LONG	13
5	364+12	363+93	3	15 FEET	ROW C = 32 FT LONG	5
					ROW B = 30 FT LONG	5
					ROW A = 28 FT LONG	5

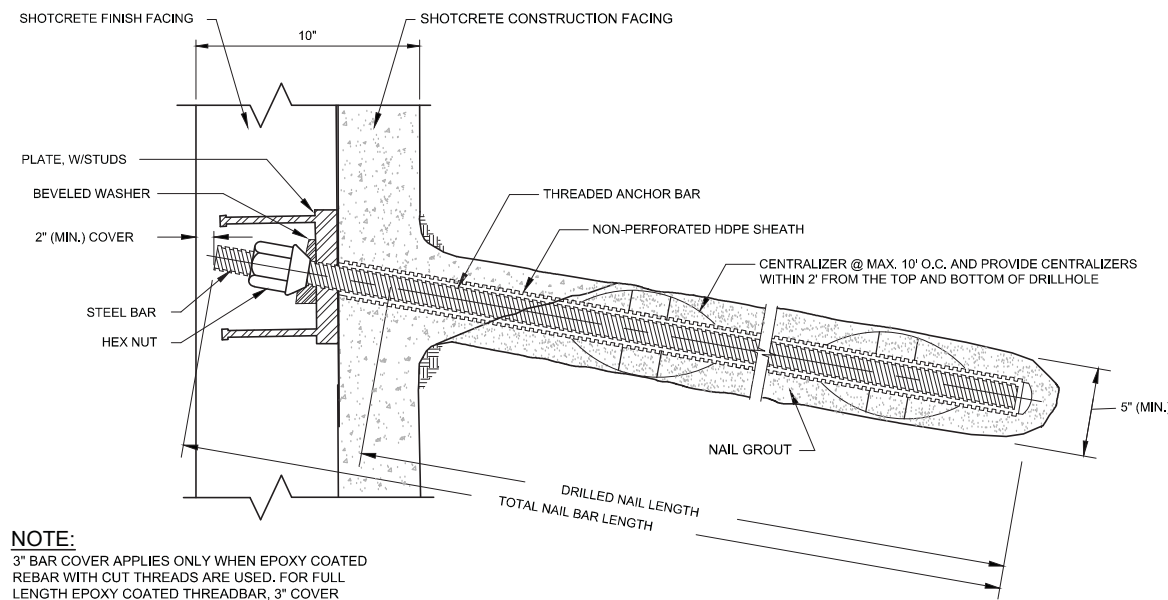

NOTE:
3" BAR COVER APPLIES ONLY WHEN EPOXY COATED REBAR WITH CUT THREADS ARE USED. FOR FULL LENGTH EPOXY COATED THREADBAR, 3" COVER REQUIREMENT IS NOT REQUIRED.

TYPICAL SOIL NAIL DETAIL & CORROSION PROTECTION REQUIREMENTS
NOT TO SCALE

NOTES:

1. ALL REINFORCING STEEL SHALL BE GRADE 60.
2. THREADED ANCHOR BAR SHALL BE GRADE 60.
3. REFER TO ALL NOTES AND SPECIFICATIONS.

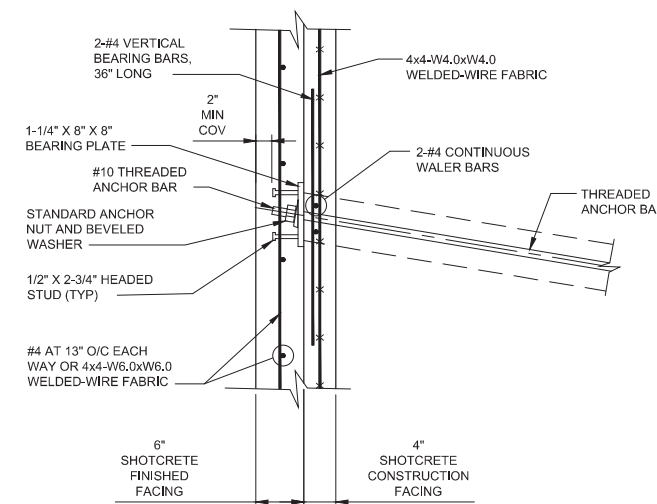

TYPICAL SOIL NAIL HEAD AND WALL DETAIL
1"=1'-0"

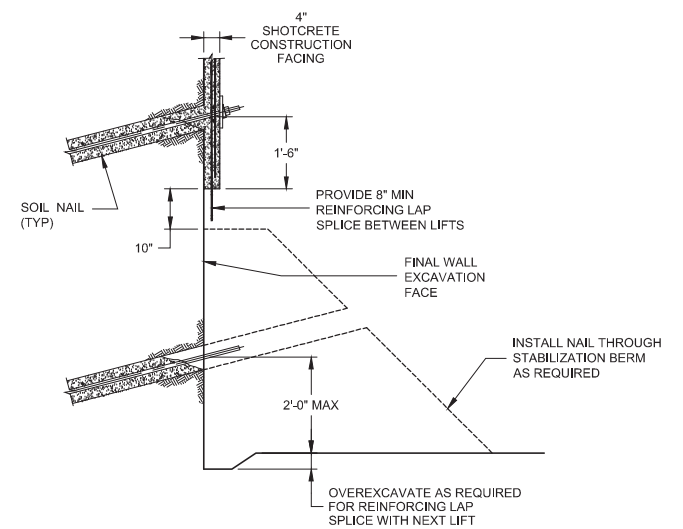

TYPICAL EXCAVATION DETAIL
NOT TO SCALE

PROPOSAL

MASSACHUSETTS BAY TRANSPORTATION AUTHORITY
T
GREEN LINE EXTENSION PROJECT
MBTA CONTRACT NO. E22CN04
CAMBRIDGE/SOMERVILLE, MASSACHUSETTS

SOIL NAIL WALL SECTION AND DETAILS



GV20170258-272.pdf

ISSUE	DATE	DESCRIPTION	BY	CHKD	APP.	SCALE: AS NOTED	DRAWN BY	DESIGN BY	CHECK BY	PLAN NO.	ISSUE
						DATE: SEPT. 28, 2017	DL	STS	RJP	SHEET: S-005	

PLOTTED: 09/22/17 10:23AM BY: CEBRON/L/ANDI
 DRAWING: \\GZANORP\REP\2018\01\PROJECTS\18R\FIGURES\CAD\GZA-SEC-DET-FW-MW-10-PROPOSAL.DWG [S-006] 09/22/17 11:42AM

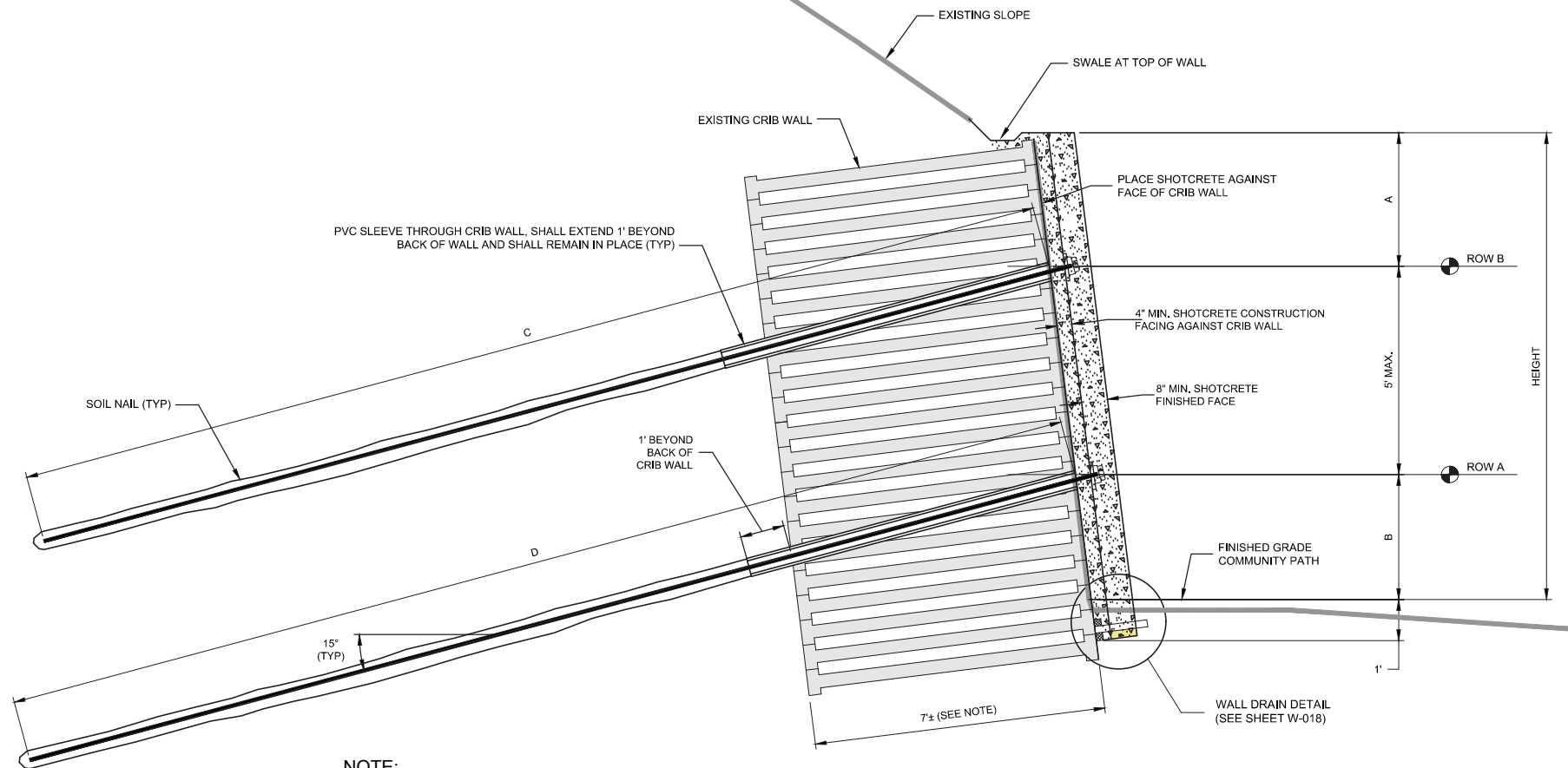

NOTE:
 WALL WIDTH BASED ON INFORMATION CONTAINED IN REPORT ENTITLED "NONDESTRUCTIVE TESTING CRIB WALLS ME-1 AND MW-2 EVERGREEN WALLS ME-4 AND ME-5 FOR THE GREEN LINE EXTENSION PROJECT SOMERVILLE, MASSACHUSETTS" PREPARED BY NDT CORPORATION DATED DECEMBER 2016.

TYPICAL WALL SECTION



CRIB WALL SCHEDULE

WALL DESIGNATION	HEIGHT (FT)	STATION (MB-EB)		A (FT)	B (FT)	C (FT)	D (FT)	MIN. DISTANCE TO ROW FROM TOP OF WALL (FT)
		FROM	TO					
MCW-2	12'	252+79	258+25	3'	3'	34'	34'	35'
MCW-3	9'	285+41	289+08	2'	2'	25'	26'	26'

- NOTES:**
1. ALL REINFORCING STEEL SHALL BE GRADE 60.
 2. THREADED ANCHOR BAR SHALL GRADE 60.
 3. REFER TO ALL NOTES AND SPECIFICATIONS.

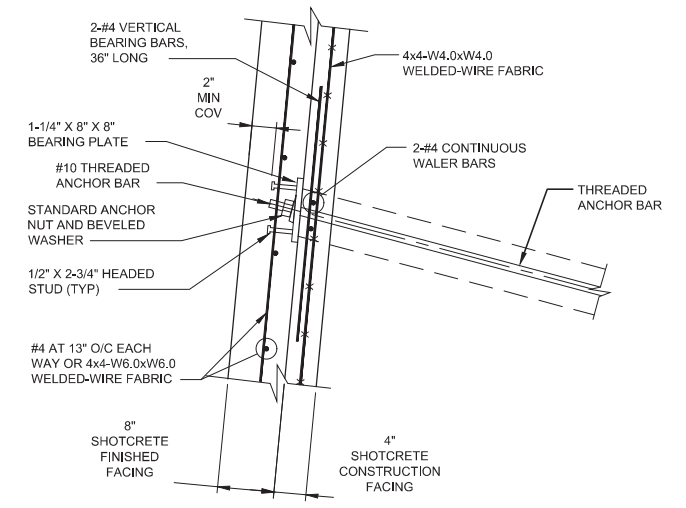

TYPICAL SOIL NAIL HEAD AND WALL DETAIL

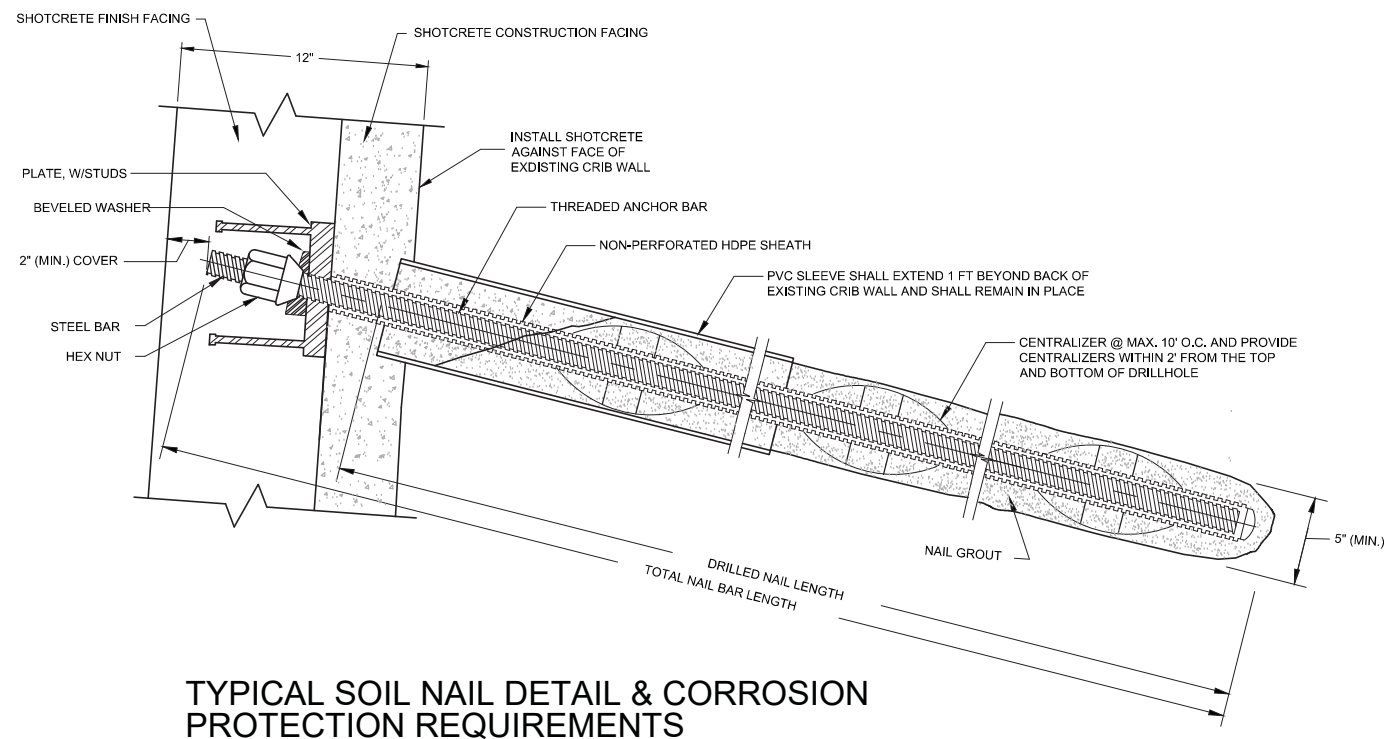

TYPICAL SOIL NAIL DETAIL & CORROSION PROTECTION REQUIREMENTS

NOT TO SCALE

PROPOSAL

MASSACHUSETTS BAY TRANSPORTATION AUTHORITY

GREEN LINE EXTENSION PROJECT
 MBTA CONTRACT NO. E22CN04
 CAMBRIDGE/SOMERVILLE, MASSACHUSETTS

SOIL NAIL CRIB WALL REPLACEMENT SECTION AND DETAILS

SCALE: AS NOTED DRAWN BY: DL DESIGN BY: STS CHECK BY: RJP			PLAN NO.		ISSUE
DATE: SEPT. 28, 2017			SHEET: S-006		

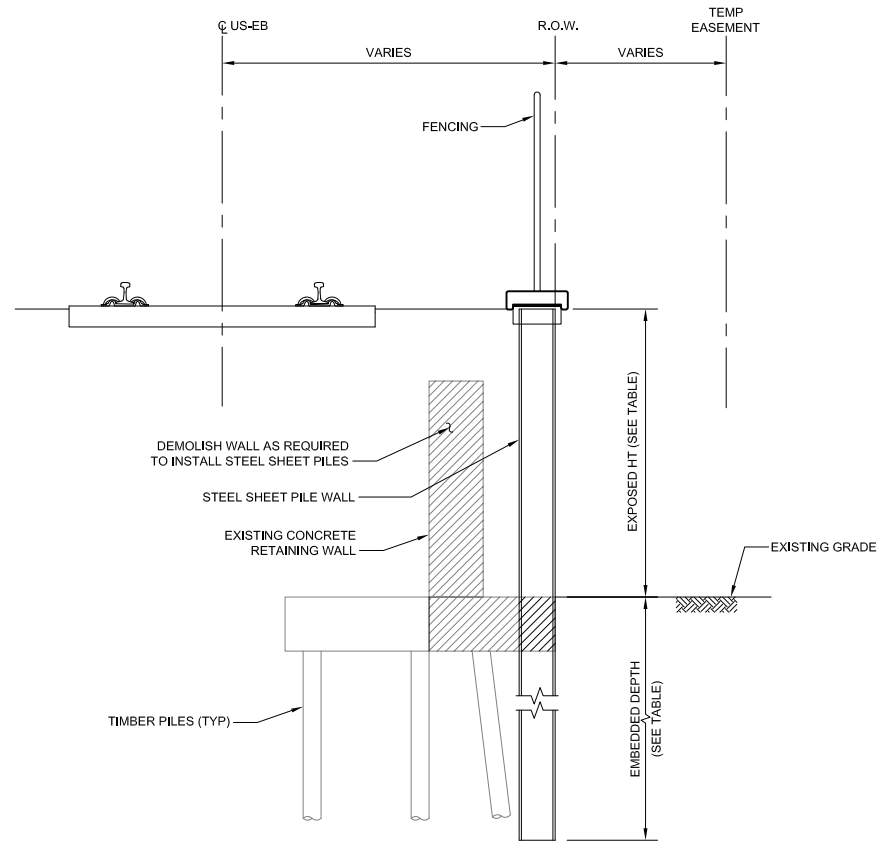

SHEET PILE RETAINING WALL

3/8"=1'-0" 0 2' 4' 6'

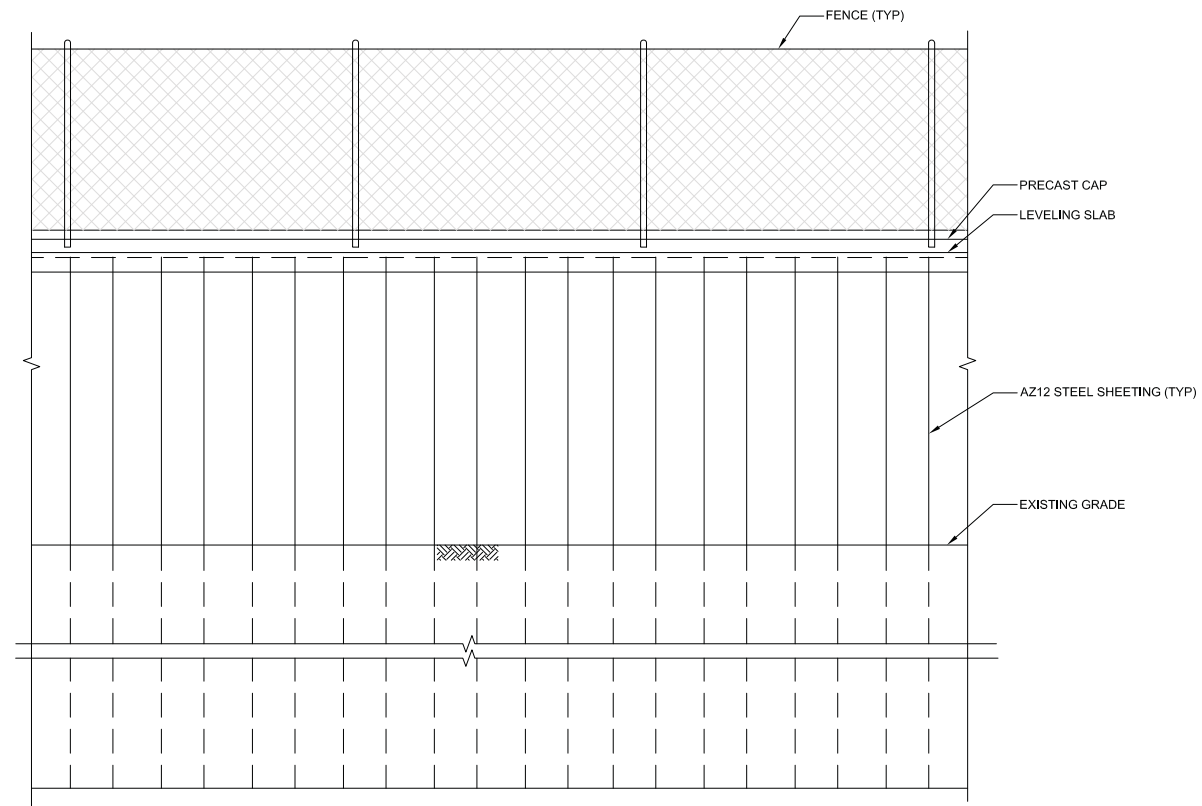

SHEET PILE RETAINING WALL ELEVATION

3/8"=1'-0" 0 2' 4' 6'

NOTE: EXISTING CONCRETE WALL BEHIND SHEET PILE WALL NOT SHOWN FOR CLARITY.

NOTES:

1. STEEL SHEETS SHALL BE GRADE 50, HOT DIPPED GALVANIZED.
2. PRECAST CONCRETE.
3. CAST IN PLACE CONCRETE
4. REINFORCING STEEL.
5. AVERAGE EMBEDMENT DEPTH REQUIRED SHOWN. EXISTING TIMBER PILES WILL INTERFERE WITH STEEL SHEETS SO ACTUAL LENGTHS WILL NEED TO BE ADJUSTED ACCORDINGLY.

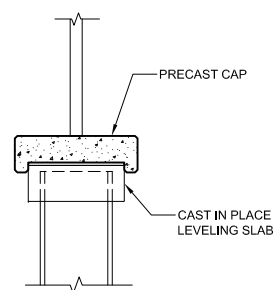

PRECAST CAP DETAIL

3/4"=1'-0" 0 1' 2' 3'

SHEET PILE RETAINING WALL TABLE						
WALL	STATION (UNION SQUARE BRANCH)		EXPOSED HT (FT)	AVERAGE EMBEDMENT DEPTH (FT)	STEEL SHEET SIZE	NOTES
	START	END				
UN-2	28+80	31+00	9	28	AZ12	SEE NOTE 5
	31+00	34+00	4	15	AZ12	SEE NOTE 5

PROPOSAL

MASSACHUSETTS BAY TRANSPORTATION AUTHORITY



GREEN LINE EXTENSION PROJECT
MBTA CONTRACT NO. E22CN04
CAMBRIDGE/SOMERVILLE, MASSACHUSETTS

**SHEET PILE WALL
ELEVATION, SECTION AND DETAILS**



GV20170258-272.pdf

SCALE: AS NOTED	DRAWN BY	DESIGN BY	CHECK BY	PLAN NO.	ISSUE
DATE: SEPT. 28, 2017	DH	EE	EE	SHEET: S-008	

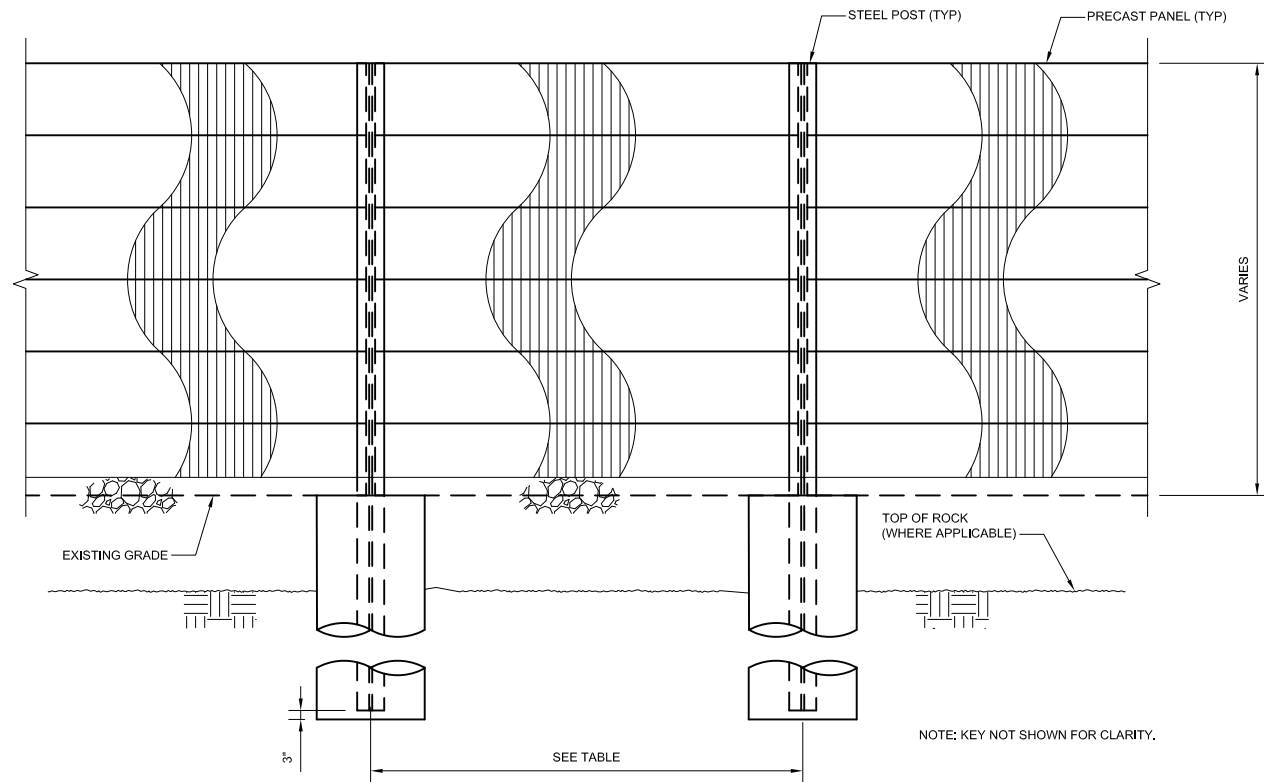

NOISE BARRIER ELEVATION

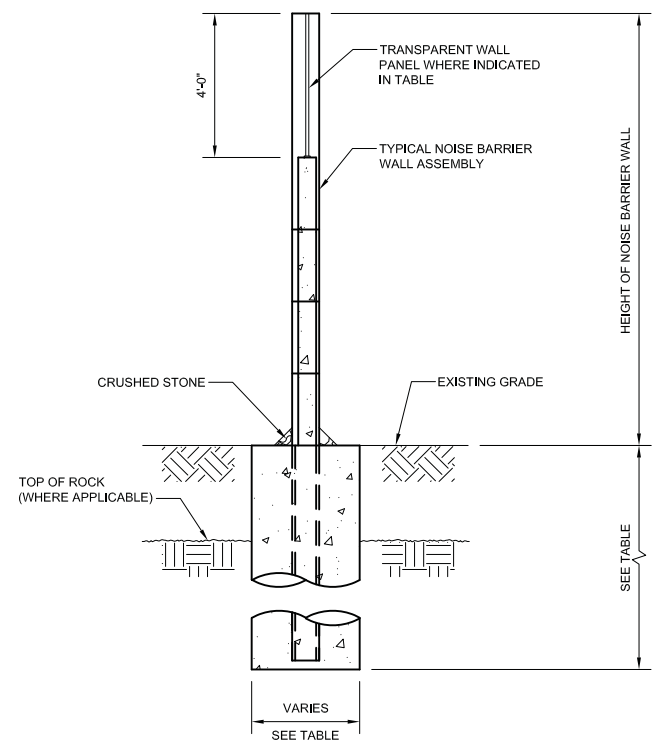

TYPICAL NOISE BARRIER WALL

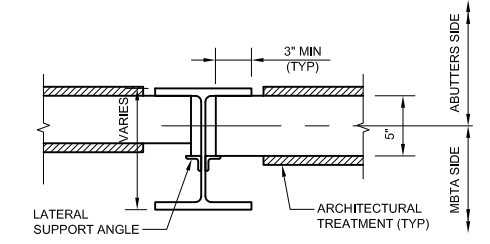

DETAIL

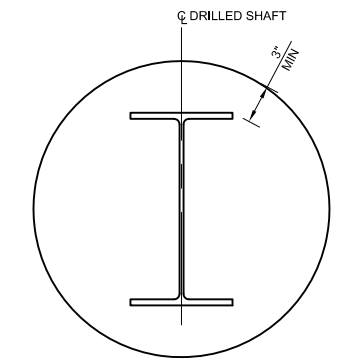

SECTION - POST WITH DRILLED SHAFT



NOISE BARRIER TABLE														
BARRIER	STATION		OFFSET (FT)	PILE SIZE	PILE SPACING (FT)	SHAFT DIAMETER (FT)	EXPOSED FACE (FT)	PILE LENGTH (FT)	SOIL EMBEDMENT (FT)	ROCK SOCKET (FT)	ABSORPTIVE TREATMENT	STRENGTH RATIO	DEFLECTION RATIO	NOTES
	START	END												
N-1A	192+74	195+53	8	W8x35	12	-	12	12	-	-	BOTH SIDES	0.41	0.34	MOUNTED ON VIADUCT/MSE WALL
N-1B	192+25	199+00	10.2	W8x35	12	-	13	13	-	-	TRACK SIDE	0.48	0.44	MOUNTED ON VIADUCT/MSE WALL
N-2A	211+53	218+91	10.3	W8x35	12	-	8	8	-	-	TRACK SIDE	0.18	0.10	MOUNTED ON VIADUCT/MSE WALL
N-2B	039+80	215+00	12	W8x35	12	1.5	10	20	10	-	TRACK SIDE	0.63	0.26	
	215+00	218+12	12	W8x35	12	1.5	8	17	9	-	TRACK SIDE	0.43	0.13	
N-3A	012+32	018+68	11 TO 8	W12x40	12	2	12	24	12	-	TRACK SIDE	0.82	0.14	DESIGNED FOR VEHICLE IMPACT. TOP 4 FT. IS ACRYLIC PANELS.
N-3B	005+84	011+48	16 TO 8	W12x40	12	2	12	24	12	-	BOTH SIDES	0.82	0.14	DESIGNED FOR VEHICLE IMPACT. TOP 4 FT. IS ACRYLIC PANELS.
N-6	254+03	254+50	67 TO 47	W12x50	12	2	16	35	19	-	TRACK SIDE	0.84	0.34	
	254+50	256+00	67 TO 47	W10x45	12	2	14	32	13	5	TRACK SIDE	0.87	0.36	
	256+00	256+50	67 TO 47	W12x53	12	2	32	15	-	TRACK SIDE	0.89	0.38		
	256+50	257+00	67 TO 47	W12x65	12	2	19	35	16	-	TRACK SIDE	0.84	0.42	
	257+00	262+00	67 TO 47	W12x58	12	2	18	33	15	-	TRACK SIDE	0.87	0.40	
N-7	262+00	262+32	67 TO 47	W12x65	12	2	16	33	17	-	TRACK SIDE	0.87	0.25	
	276+29	279+00	45 TO 48	W12x40	12	2	14	26	7	5	TRACK SIDE	0.69	0.29	
	279+00	280+50	45 TO 48	W8x35	12	1.5	12	23	6	5	TRACK SIDE	0.87	0.45	
	280+50	282+00	45 TO 48	W8x35	12	1.5	10	20	5	5	TRACK SIDE	0.63	0.26	
N-9A	282+00	284+00	45 TO 48	W8x35	12	1.5	8	17	9	-	TRACK SIDE	0.28	0.13	
	284+00	284+64	45 TO 48	W8x35	12	1.5	10	20	10	-	TRACK SIDE	0.63	0.26	
	298+06	301+11	41	W12x50	12	2	18	31	8	5	TRACK SIDE	0.87	0.49	
N-9B	300+48	303+50	73 TO 41	W12x58	12	2	18	39	11	10	TRACK SIDE	0.88	0.40	
	303+50	304+34	73 TO 41	W12x72	12	2	20	42	12	10	TRACK SIDE	0.84	0.44	
N-10	305+35	306+00	44 TO 41	W8x35	12	1.5	8	24	16	-	TRACK SIDE	0.47	0.13	
	306+00	308+50	44 TO 41	W12x45	12	2	15	33	18	-	TRACK SIDE	0.81	0.32	
	308+50	309+63	39 TO 51	W8x35	12	1.5	10	23	13	-	TRACK SIDE	0.72	0.26	
	309+63	313+00	39 TO 51	W21x44	8	-	10	-	-	-	TRACK SIDE	-	-	MOUNTED ON RETAINING WALL
	313+00	314+50	39 TO 51	W24x58	8	-	8	-	-	-	TRACK SIDE	-	-	MOUNTED ON RETAINING WALL
N-11	320+22	321+09	40.5 TO 49	W8x35	12	1.5	10	30	20	-	TRACK SIDE	0.70	0.26	
N-12	321+55	324+85	43.5	W10x33	12	2	12	26	14	-	TRACK SIDE	0.88	0.33	
N-14A	330+39	332+21	42	W12x40	12	2	16	28	12	-	TRACK SIDE	0.87	0.44	
N-14B	333+62	336+00	38	W12x45	12	2	17	29	12	-	TRACK SIDE	0.87	0.46	
	336+00	336+29	38	W12x40	12	2	15	27	12	-	TRACK SIDE	0.77	0.36	
N-15	223+1	225+50	48 TO 56	W21x48	8	-	8	-	-	-	TRACK SIDE	-	-	MOUNTED ON RETAINING WALL
	225+50	227+00	55 TO 47	W24x55	8	-	10	-	-	-	TRACK SIDE	-	-	MOUNTED ON RETAINING WALL
	227+00	231+05	47 TO 53	W21x44	8	-	8	-	-	-	TRACK SIDE	-	-	MOUNTED ON RETAINING WALL
N-17	231+05	235+42	47 TO 53	W8x35	12	1.5	8	21	13	-	TRACK SIDE	0.53	0.13	
	037+23	041+94	14 TO 11	W12x40	12	2	16	28	12	-	TRACK SIDE	0.87	0.44	

PROPOSAL

MASSACHUSETTS BAY TRANSPORTATION AUTHORITY
T
 GREEN LINE EXTENSION PROJECT
 MBTA CONTRACT NO. E22CN04
 CAMBRIDGE/SOMERVILLE, MASSACHUSETTS

NOISE BARRIER ELEVATION, SECTION AND DETAILS

GV20170258-272.pdf

SCALE: AS NOTED	DRAWN BY: []	DESIGN BY: []	CHECK BY: []	PLAN NO.:	ISSUE
DATE: SEPT. 28, 2017	DH	EE	EE	SHEET: S-009	[]
ISSUE	DATE	DESCRIPTION	BY	CHKD	APP.

PLOTTED: 09/29/17 9:18PM BY: JAL:ED
 DRAWING: I:\PROJECTS\GLX\TECH DESIGN\RETAINING WALLS-NOISE WALLS\PROPOSAL DRAWINGS\S-009 NOISE BARRIER WALL DETAILS.DWG [LAYOUT] 09/22/17

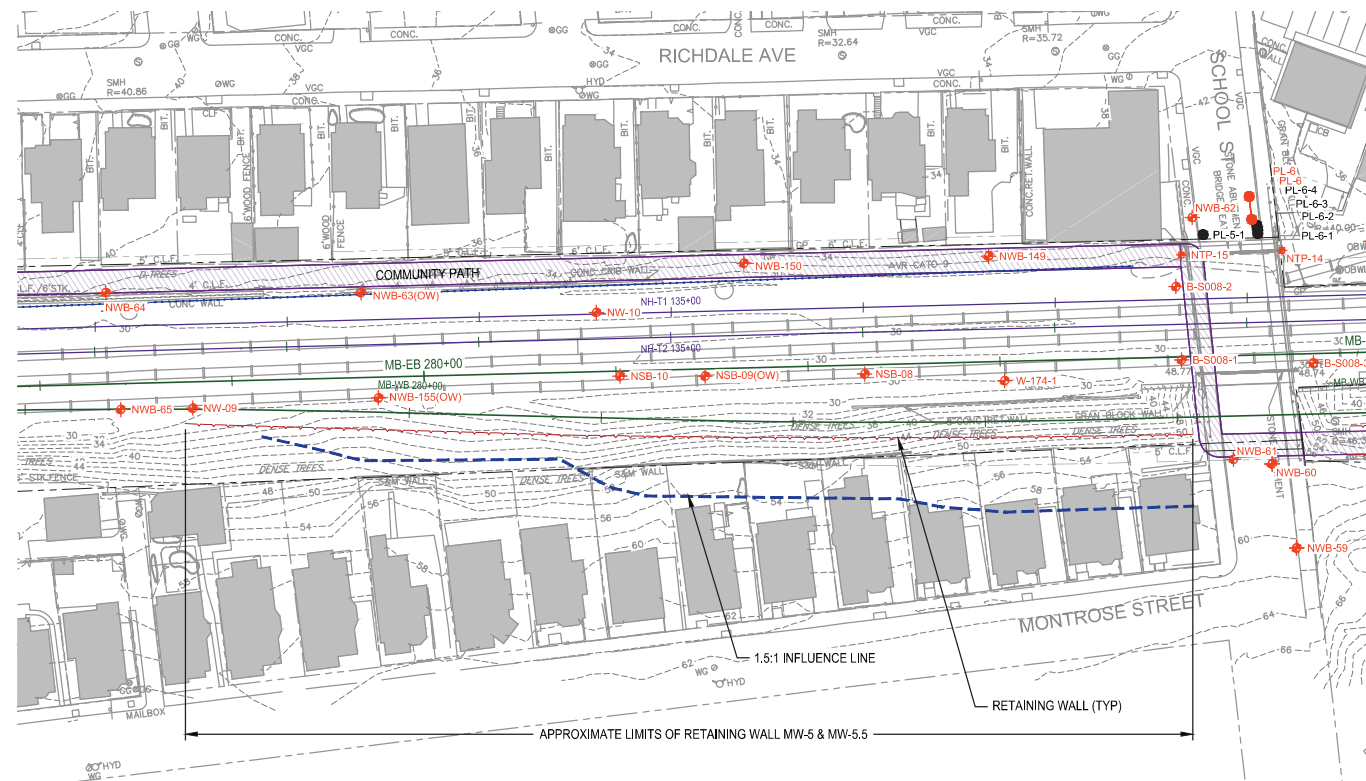

PLAN

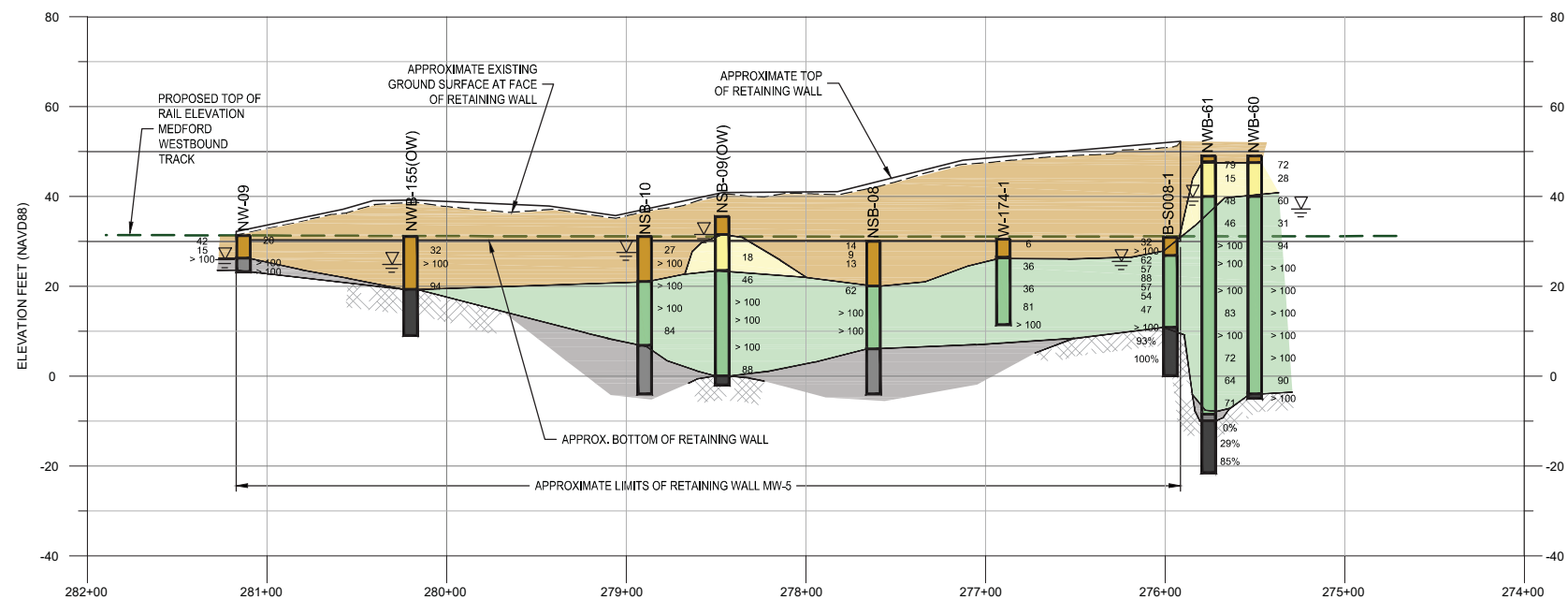

SUBSURFACE PROFILE - MEDFORD WESTBOUND TRACK

LEGEND

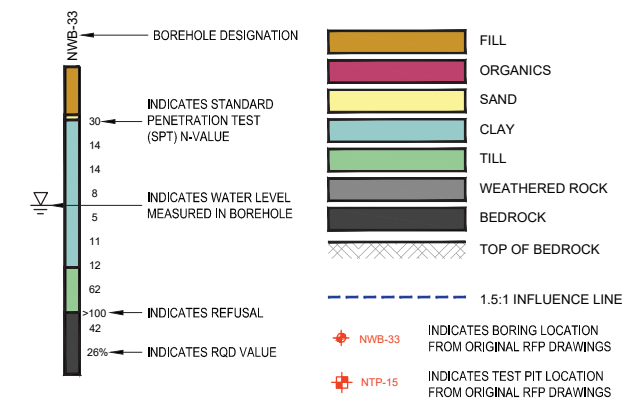

PROPOSAL

MASSACHUSETTS BAY TRANSPORTATION AUTHORITY
T
 GREEN LINE EXTENSION PROJECT
 MBTA CONTRACT NO. E22CN04
 CAMBRIDGE/SOMERVILLE, MASSACHUSETTS

RETAINING WALL MW-5
 PLAN & SUBSURFACE PROFILE

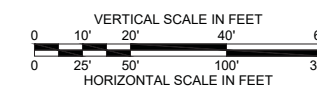

NOTES:

- EXISTING GROUND PROFILE DEVELOPED FROM CONTOURS PROVIDED IN EXISTING BASE MAP DRAWING FILE ISSUED WITH RFP DOCUMENTS.
- SUBSURFACE INFORMATION INCLUDING GROUNDWATER ELEVATIONS ARE BASED ON BORINGS PROVIDED IN THE RFP DOCUMENTS. BORINGS OBSERVED BY OTHERS.
- BORING LOCATIONS AND SUBSURFACE INFORMATION SHOULD BE CONSIDERED APPROXIMATE.



GV20170258-272.pdf

SCALE: AS NOTED	DRAWN BY: DL	DESIGN BY: STS	CHECK BY: RJP	PLAN NO.	ISSUE
DATE: SEPT. 28, 2017				SHEET: S-010	

PLOTTED: 09/29/17 9:58AM BY: BFORAN/LAND
 DRAWING: \\GZANORZ\RFPA\2018\LOT\PO00061\RFPA\FIGURES\CADD\GZA-PROFILE-RW-PROPOSAL.DWG [S=010] 09/22/17 9:57AM

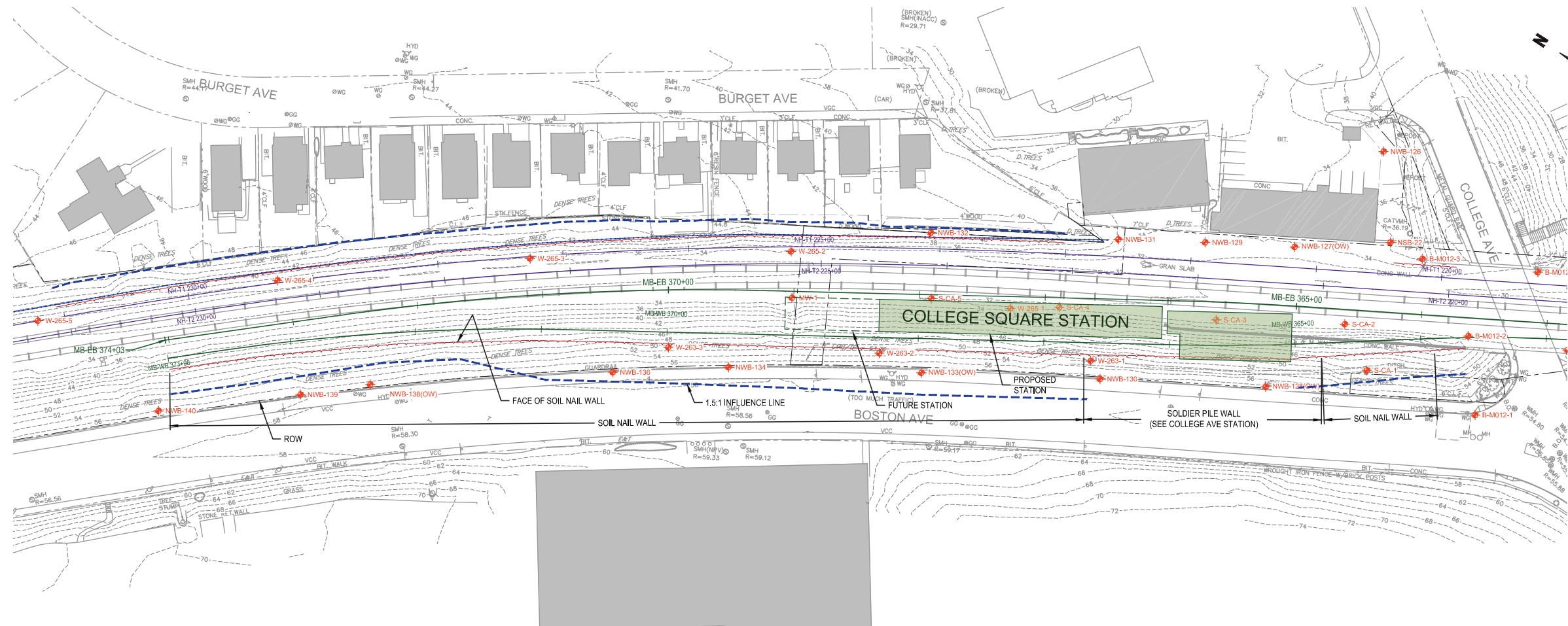

PLAN

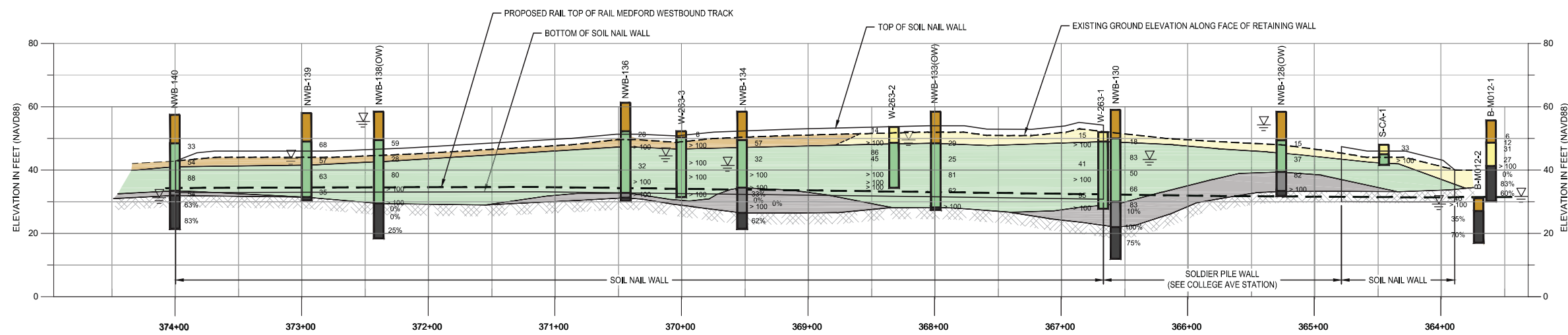

SUBSURFACE PROFILE - MEDFORD WESTBOUND TRACK

LEGEND

- NWB-33 BOREHOLE DESIGNATION
- INDICATES STANDARD PENETRATION TEST (SPT) N-VALUE
- INDICATES WATER LEVEL MEASURED IN BOREHOLE
- INDICATES REFUSAL
- INDICATES RQD VALUE
- FILL
- ORGANICS
- SAND
- CLAY
- TILL
- WEATHERED ROCK
- BEDROCK
- TOP OF BEDROCK
- NWB-33 INDICATES BORING LOCATION FROM ORIGINAL RFP DRAWINGS
- NTP-15 INDICATES TEST PIT LOCATION FROM ORIGINAL RFP DRAWINGS

PROPOSAL

MASSACHUSETTS BAY TRANSPORTATION AUTHORITY

T

GREEN LINE EXTENSION PROJECT
 MBTA CONTRACT NO. E22CN04
 CAMBRIDGE/SOMERVILLE, MASSACHUSETTS

**RETAINING WALL MW-10
 PLAN & SUBSURFACE PROFILE**

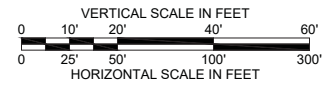

- NOTE:**
- EXISTING GROUND PROFILE DEVELOPED FROM CONTOURS PROVIDED IN EXISTING BASE MAP DRAWING FILE ISSUED WITH RFP DOCUMENTS.
 - SUBSURFACE INFORMATION INCLUDING GROUNDWATER ELEVATIONS ARE BASED ON BORINGS PROVIDED IN THE RFP DOCUMENTS. BORINGS OBSERVED BY OTHERS.
 - BORING LOCATIONS AND SUBSURFACE INFORMATION SHOULD BE CONSIDERED APPROXIMATE.

STV 100 Years

massDOT
 Massachusetts Department of Transportation

GLX CONSTRUCTORS

SCALE: AS NOTED
 DRAWN BY: DL
 DESIGN BY: STS
 CHECK BY: RJP

DATE: SEPT. 28, 2017

PLAN NO.
 SHEET: S-011

ISSUE

GV20170258-272.pdf

PLOTTED: 09/29/17 10:01AM BY: RFP04/LL/LL
 DRAWING: \\GZANDES\RFP_2018\LOT_P000061\RFP_FIGURES\CAD_GEA_PROFILE-RW-PROPOSAL.DWG [S-011] 09/22/17 10:00AM

9/21/2017 1:23:10 PM I:\PROPOSALS\2017\GLX\Drawings\Proposal Drawings\S-017 Lechmere Viaduct Split Framing Plan, Typical Section, Pier Elevation & Geotech.dgn

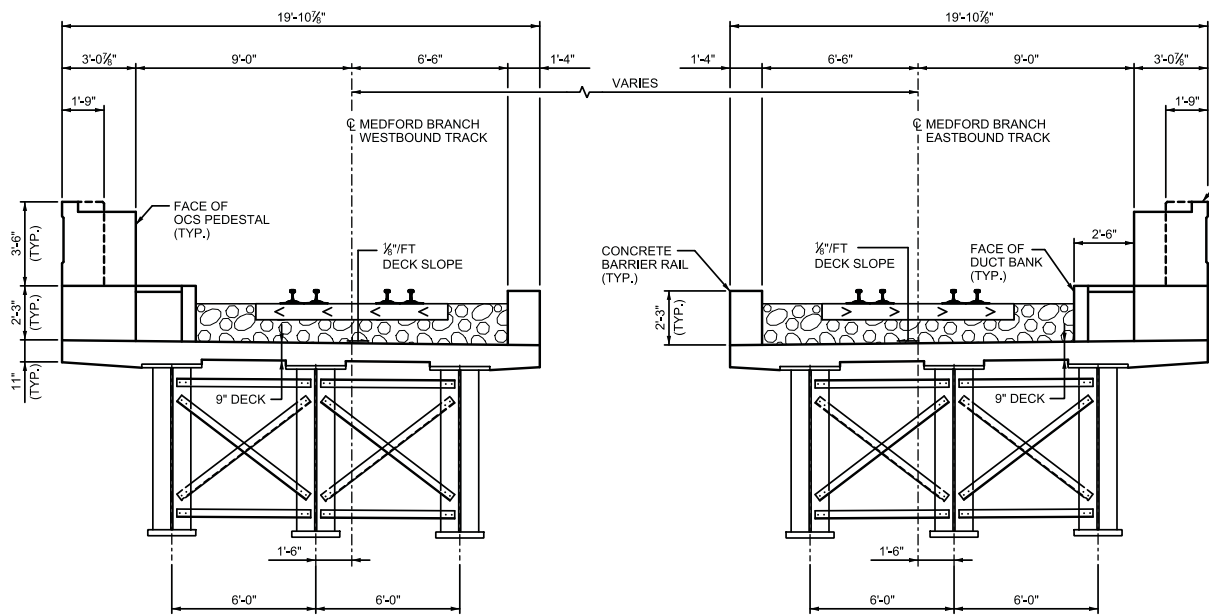

**TYPICAL SECTION
SPAN LEV-11**

1/8"=1'-0" 0 2' 4' 8'

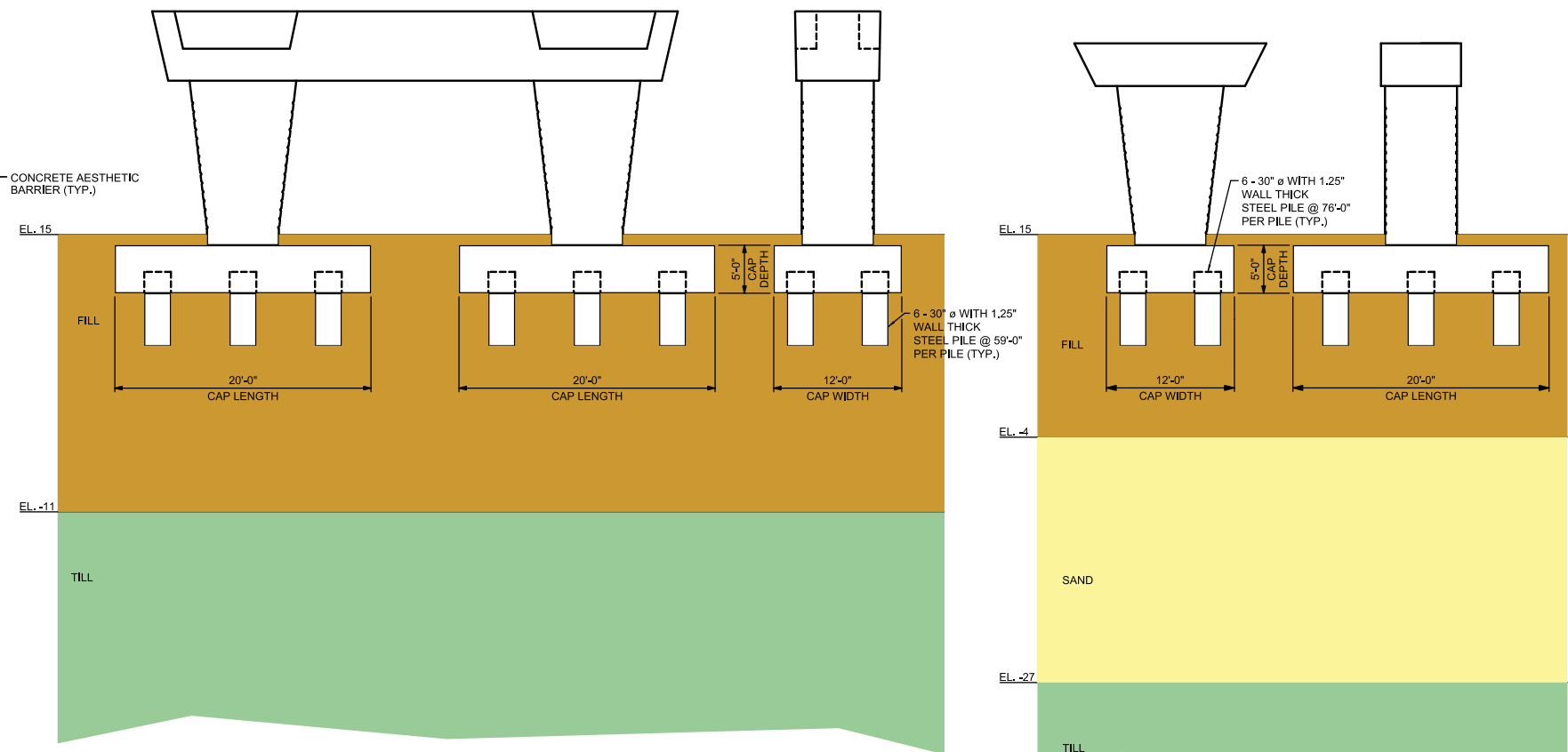

**ELEVATION
ELEVATION VIEW FOR LEV PIER 11**

**SIDE ELEVATION
ELEVATION
SIDE ELEVATION**

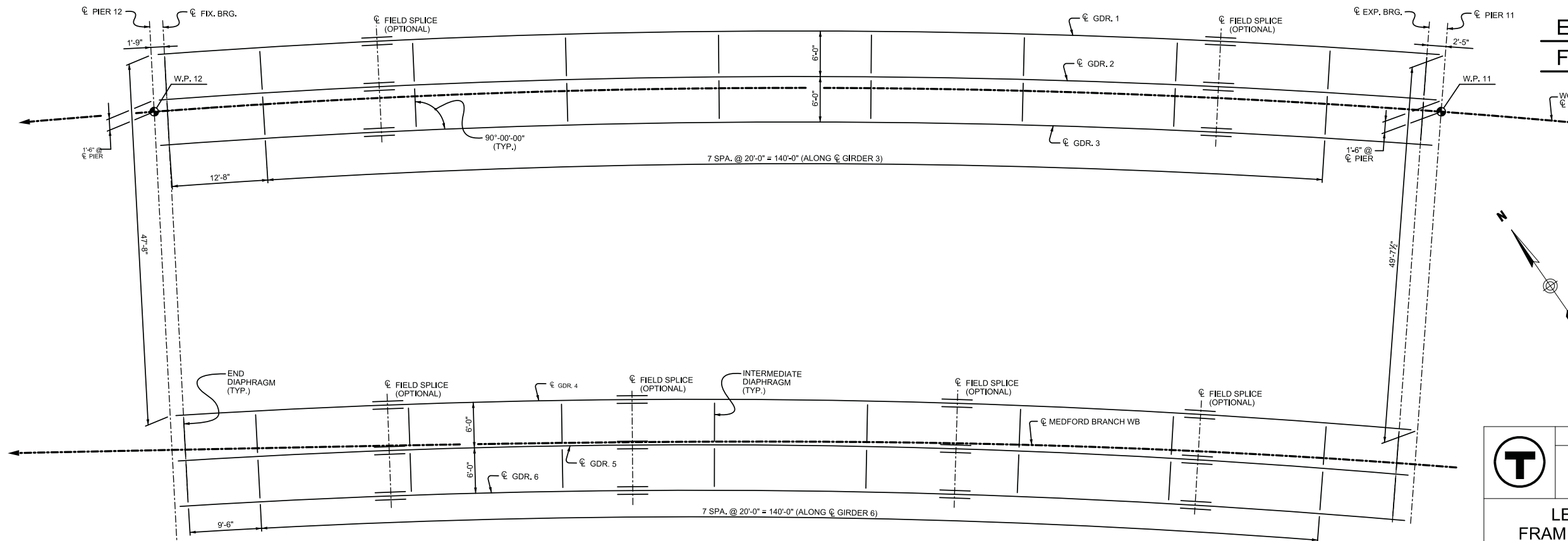

**FRAMING PLAN
SPAN LEV-11**

1/8"=1'-0" 0 4' 8' 16'

- NOTES:**
- SPAN SHOWN IS REPRESENTATIVE SPAN OF THE LECHMERE VIADUCT SPLIT SECTION.
 - STRATIGRAPHY AT PIER 11 BASED ON BORINGS NVB-68 AND NVB-12. ACTUAL CONDITIONS MAY VARY.
 - STRATIGRAPHY AT PIER 12 BASED ON BORINGS NVB-14, NVB-15, AND NVB-82. ACTUAL CONDITIONS MAY VARY.

**ELEVATION VIEW
FOR LEV PIER 12**

0 4' 8' 16'

PROPOSAL

MASSACHUSETTS BAY TRANSPORTATION AUTHORITY

GREEN LINE EXTENSION PROJECT
MBTA CONTRACT NO. E22CN04
CAMBRIDGE/SOMERVILLE, MASSACHUSETTS

**LECHMERE VIADUCT SPLIT
FRAMING PLAN, TYPICAL SECTION,
PIER ELEVATION & GEOTECH**

SCALE: AS NOTED	DRAWN BY: ATH	DESIGN BY: NML	CHECK BY: TBQ	PLAN NO. .	ISSUE
DATE: SEPT. 28, 2017				SHEET: S-013	

I:\PROPOSALS\2017\GLX\Drawings\Proposal Drawings\S-019 Medford Branch Viaduct Framing Plan, Typical Section, Pier Elevation & Geotech.dgn
 9/21/2017 1:26:18 PM

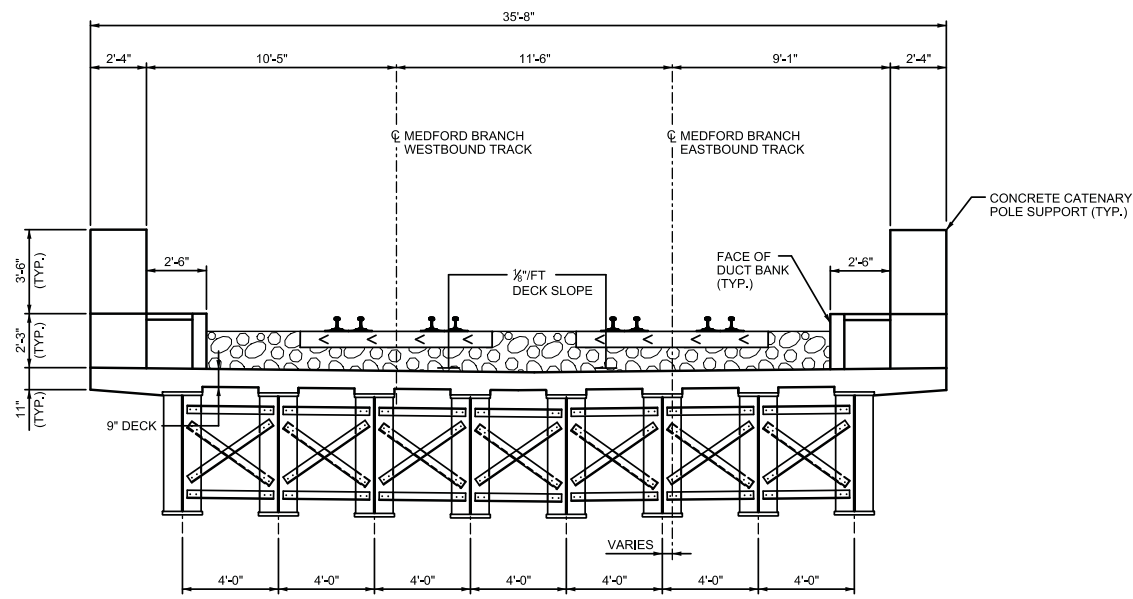

**TYPICAL SECTION
SPAN MBV-29**

1/8"=1'-0" 0 2' 4' 8'

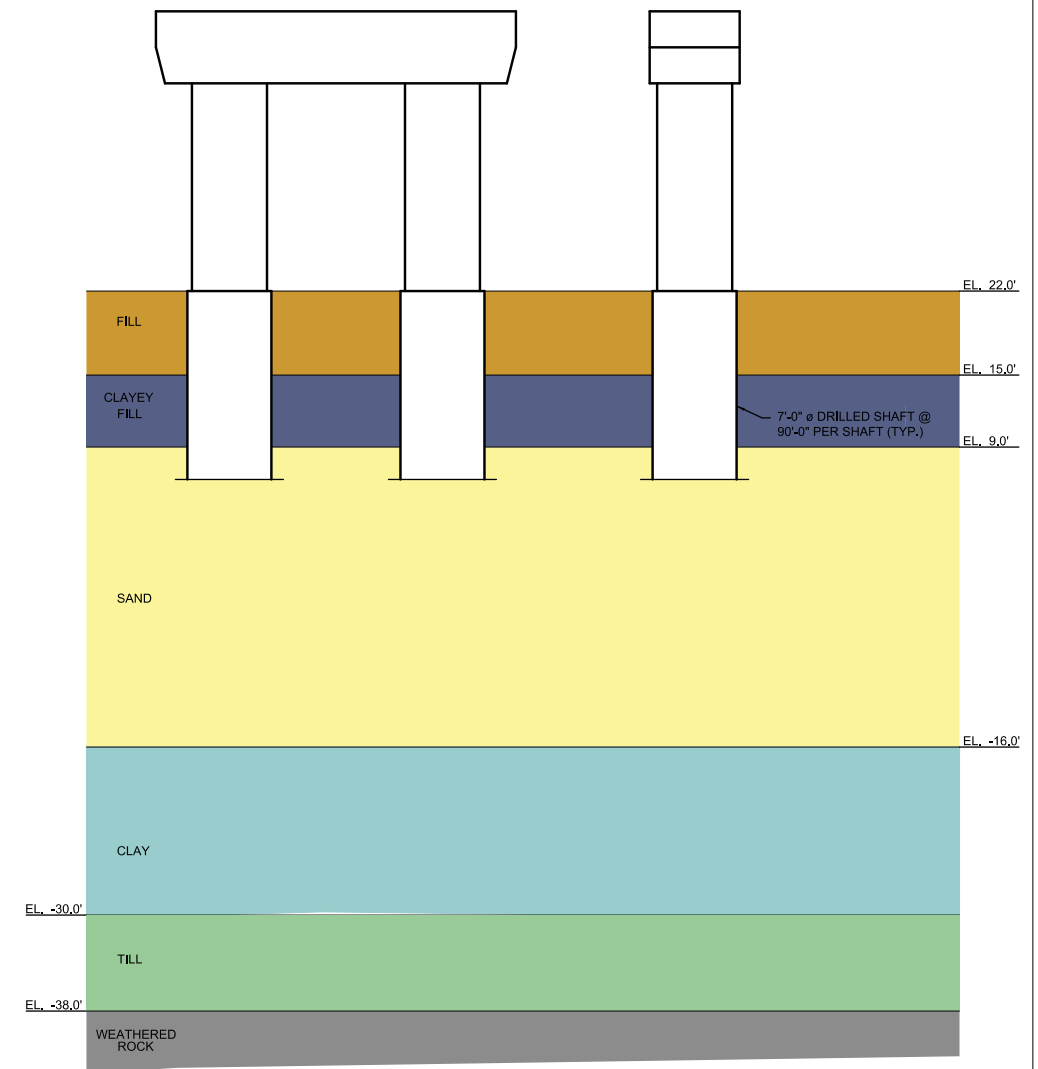

ELEVATION SIDE ELEVATION

ELEVATION VIEW FOR MBV-29

0 4' 8' 16'

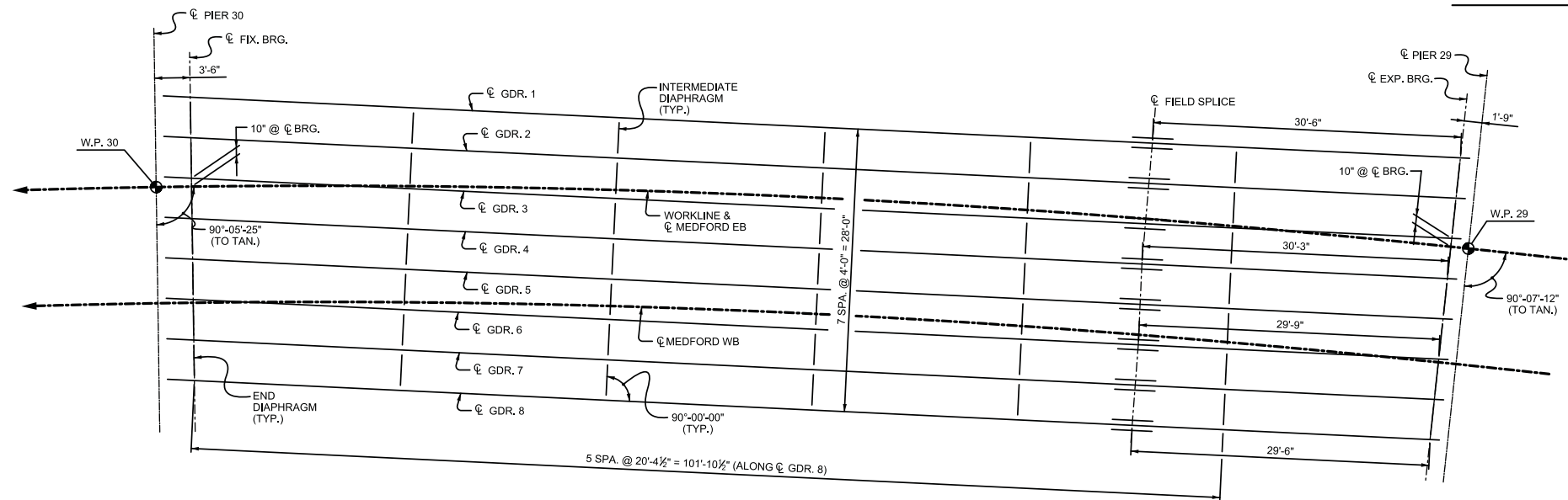
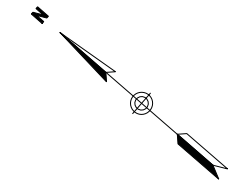

**FRAMING PLAN
SPAN MBV-29**

1/8"=1'-0" 0 4' 8' 16'

NOTES:

- SPAN SHOWN IS REPRESENTATIVE SPAN OF THE MEDFORD BRANCH VIADUCT SECTION.
- STRATIGRAPHY SHOWN BASED ON BORINGS NVB-42 AND NVB-78/78A. ACTUAL CONDITIONS MAY VARY.

PROPOSAL

MASSACHUSETTS BAY TRANSPORTATION AUTHORITY
 GREEN LINE EXTENSION PROJECT
 MBTA CONTRACT NO. E22CN04
 CAMBRIDGE/SOMERVILLE, MASSACHUSETTS



**MEDFORD BRANCH VIADUCT
 FRAMING PLAN, TYPICAL SECTION,
 PIER ELEVATION & GEOTECH**



GV20170258-272.pdf

ISSUE	DATE	DESCRIPTION	BY	CHKD	APP.	SCALE:	DRAWN BY:	DESIGN BY:	CHECK BY:	PLAN NO.:	ISSUE
						AS NOTED	ATH	NML	TBO		
	SEPT. 28, 2017									S-014	

I:\PROPOSALS\2017\GLX\Drawings\Proposal Drawings\S-021 Union Square Branch Viaduct Framing Plan, Typical Section, Pier Elevation & Geotech.dgn
 9/21/2017 1:32:16 PM

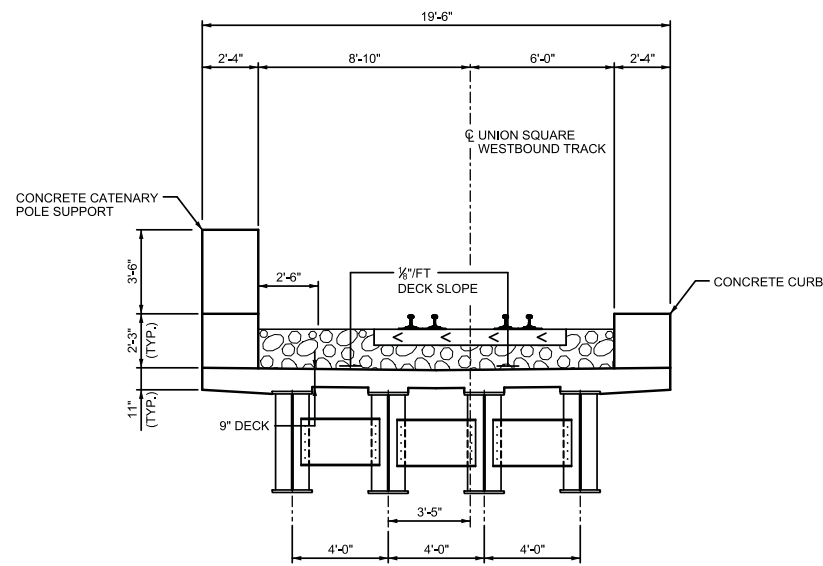

**TYPICAL SECTION
SPAN UWV-7**

1/8"=1'-0"
0 2' 4' 8'

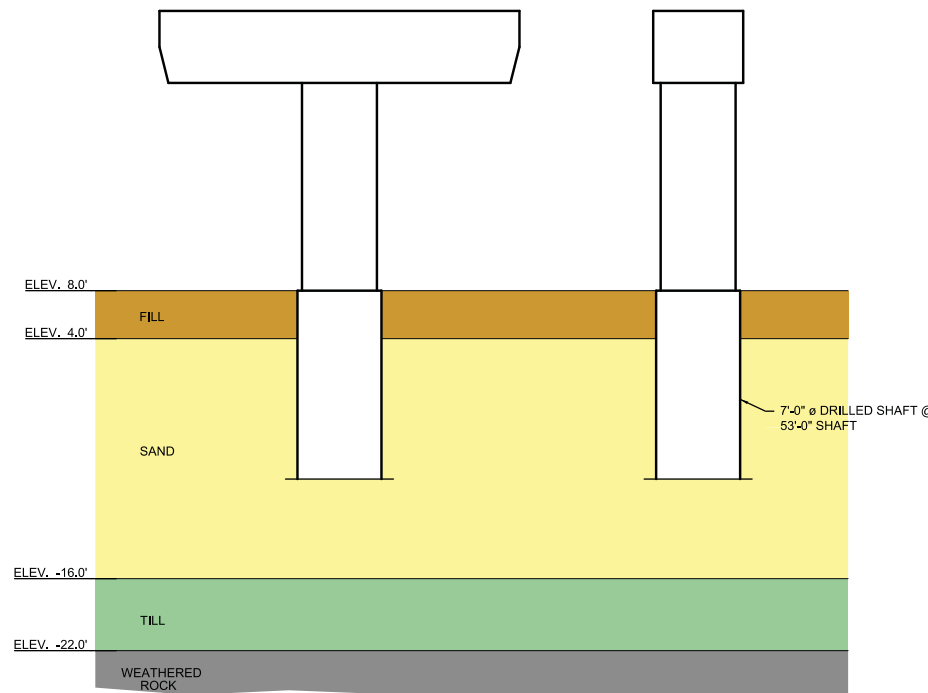

ELEVATION SIDE ELEVATION

ELEVATION VIEW FOR UWV-7

0 4' 8' 16'

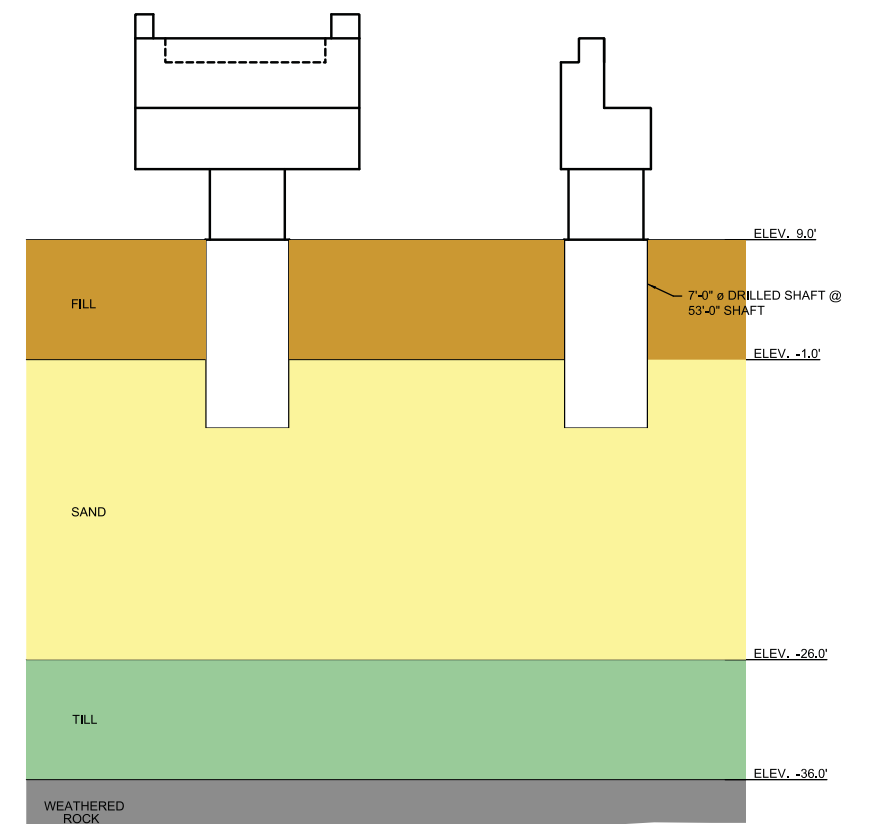

ELEVATION SIDE ELEVATION

ELEVATION VIEW FOR UWV ABUTMENT

0 4' 8' 16'

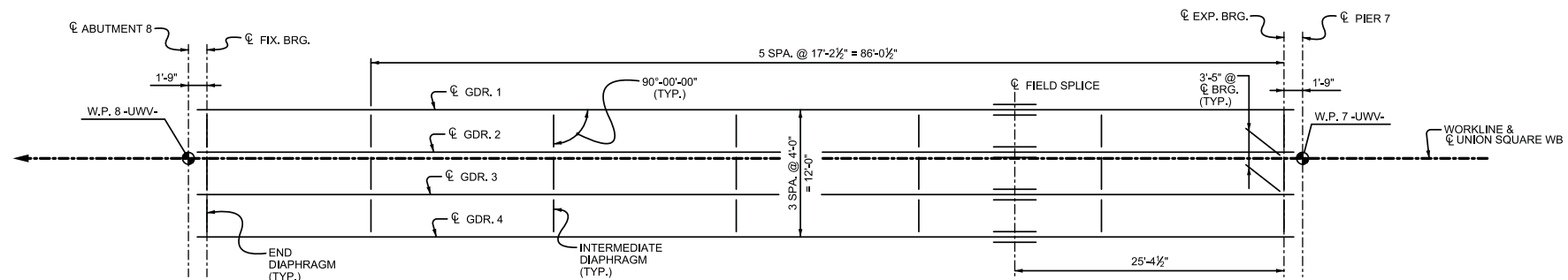

**FRAMING PLAN
SPAN UWV-7**

1/8"=1'-0"
0 4' 8' 16'

NOTES:

1. SPAN SHOWN IS REPRESENTATIVE SPAN OF THE UNION SQUARE BRANCH VIADUCT SECTION.
2. STRATIGRAPHY AT UWV ABUTMENT BASED ON BORING W-508-2. ACTUAL CONDITIONS MAY VARY.
3. STRATIGRAPHY AT UWV-7 BASED ON BORING W-508-1. ACTUAL CONDITIONS MAY VARY.

PROPOSAL

MASSACHUSETTS BAY TRANSPORTATION AUTHORITY



GREEN LINE EXTENSION PROJECT
MBTA CONTRACT NO. E22CN04
CAMBRIDGE/SOMERVILLE, MASSACHUSETTS

**UNION SQUARE BRANCH VIADUCT
FRAMING PLAN, TYPICAL SECTION,
PIER ELEVATION & GEOTECH**



GV20170258-272.pdf

SCALE: AS NOTED	DRAWN BY: ATH	DESIGN BY: NML	CHECK BY: TBQ	PLAN NO. .	ISSUE
DATE: SEPT. 28, 2017				SHEET: S-015	

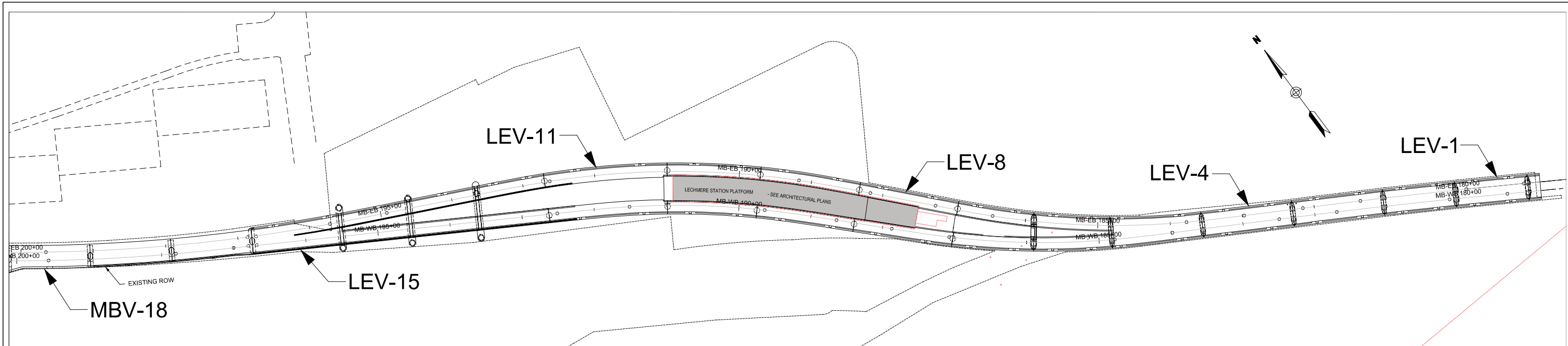

PLAN

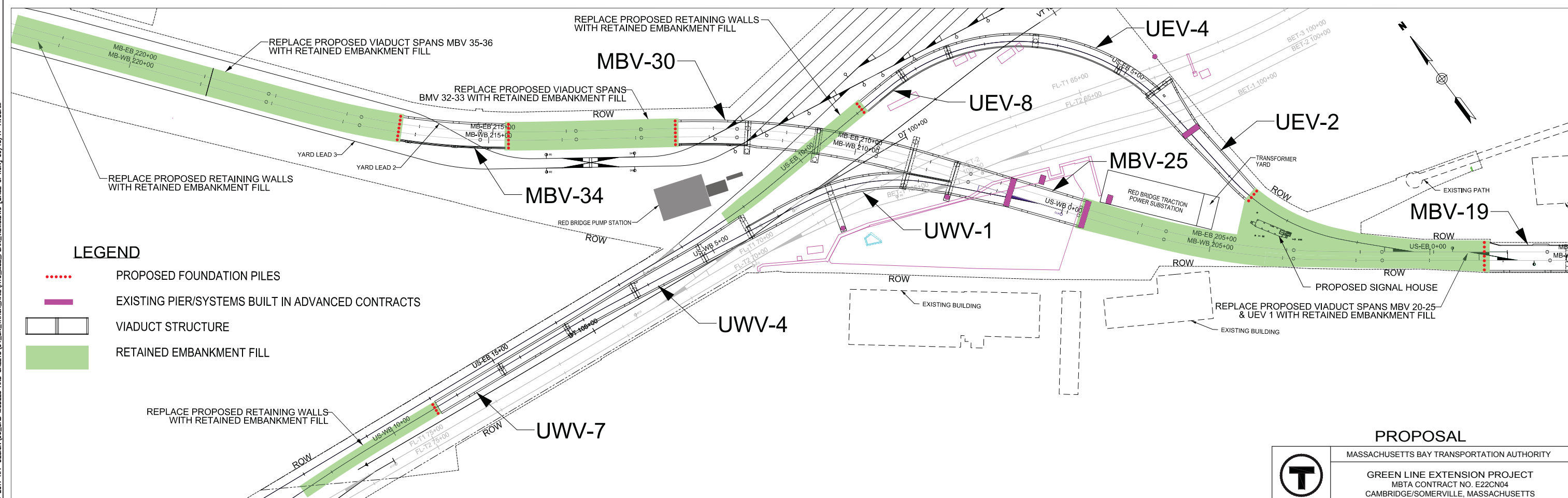

PLAN

PROPOSAL
 MASSACHUSETTS BAY TRANSPORTATION AUTHORITY
 GREEN LINE EXTENSION PROJECT
 MBTA CONTRACT NO. E22CN04
 CAMBRIDGE/SOMERVILLE, MASSACHUSETTS

ATC 35 - MSE
 PLAN VIEW

VIADUCT NAMING CONVENTION
 LEV-4 - LECHMERE VIADUCT SPAN 4
 MBV-19 - MEDFORD VIADUCT SPAN 19
 UEV-2 - UNION SQUARE EB VIADUCT SPAN 2
 UWV-7 - UNION SQUARE WB VIADUCT SPAN 7

SCALE: NTS	DRAWN BY: PJB	DESIGN BY: PJB	CHECK BY: JM	PLAN NO.:	ISSUE:
DATE: SEPT. 28, 2017				SHEET: S-016	

PLOTTED: 09/13/17 12:00PM BY: BRYANTPJ
 DRAWING: E:\PROPOSALS\2017\062620_GLE-D-B-STV-2017-REF-DESIGN\35-CAD-MODELS-AND-SHEETS\04-CR-TRACK-RAIL-VTC_MSE_PLAN_VIEWS.DWG [BASE OPTION] 09/13/17 11:58AM

PLOTTED: 09/25/17 2:33PM BY: KACHALIDY
 DRAWING: P. BRIDGES GREEN LINE - BOSTON-NC RETAINING WALLS FROM BOSTON V.70907 USE WALL OCS POLES EXHIBIT DWG [LAYOUT] 09/22/17 2:33PM

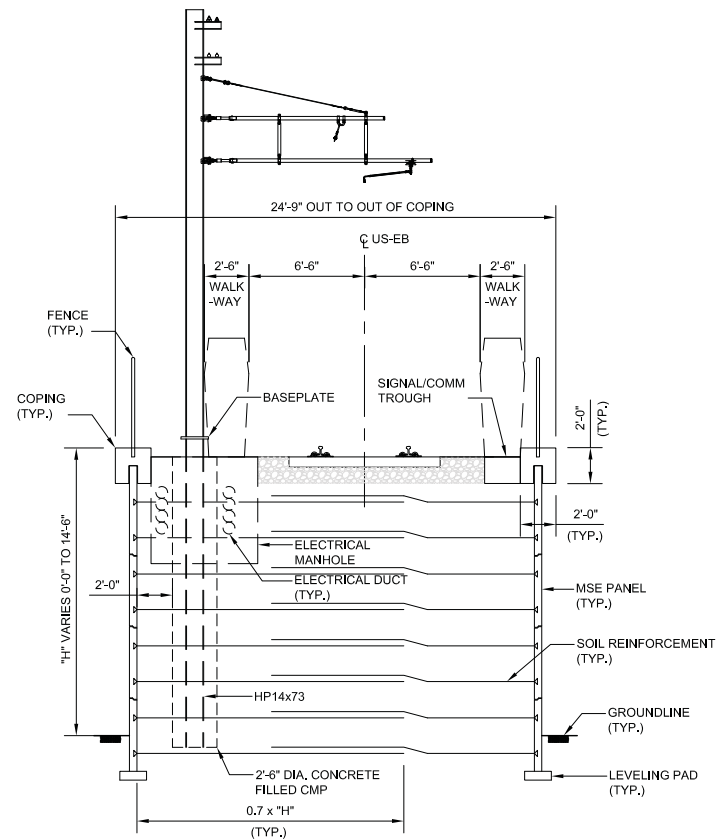

SECTION

3/16"=1'-0" 0 3' 6' 12'
 SINGLE TRACK WITH OCS POLES ON FOUNDATION IN SELECT FILL
 STA. 8+87 TO STA. 10+90 (US-EB)

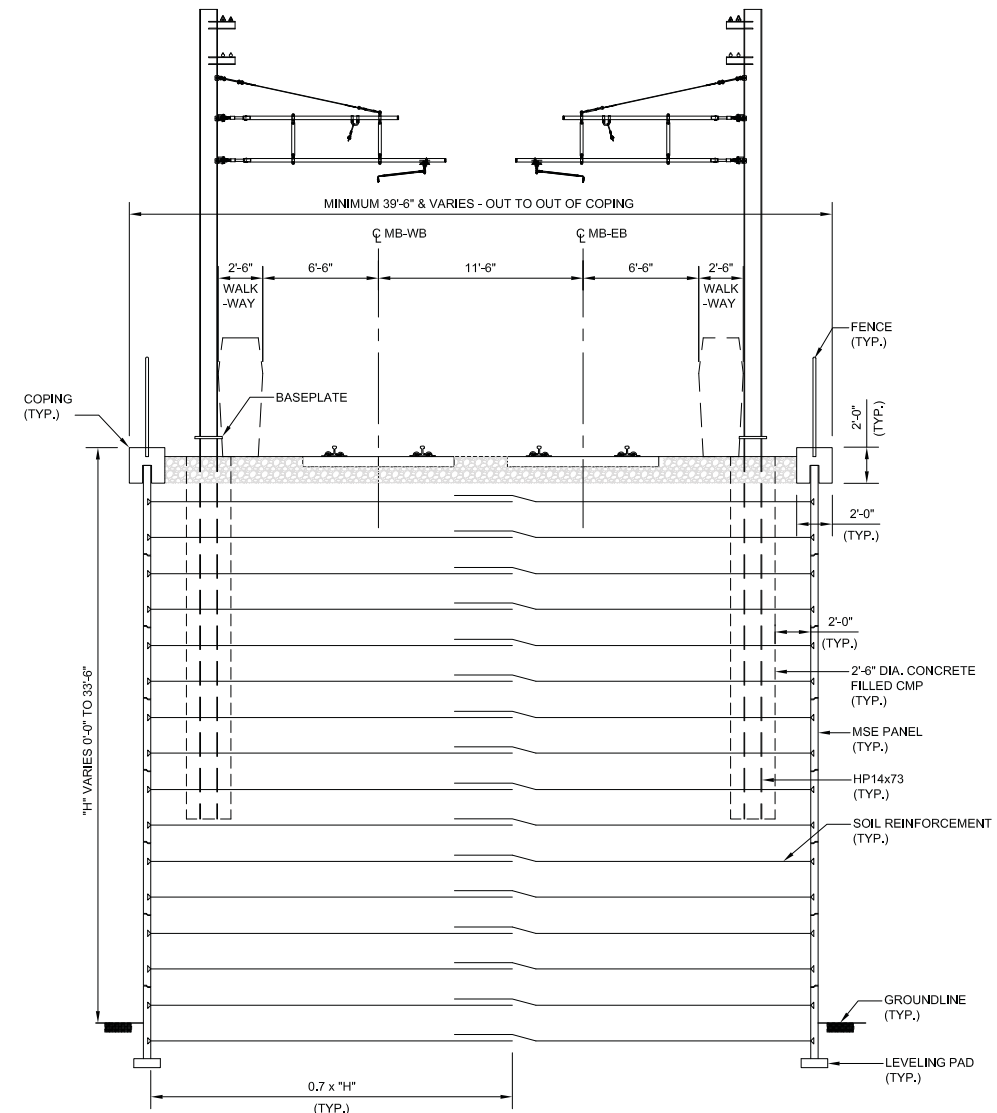

SECTION

3/16"=1'-0" 0 3' 6' 12'
 DOUBLE TRACK WITH OCS POLES
 STA. 204+25 TO STA. 206+86
 STA. 212+48 TO STA. 214+84
 STA. 216+23 TO STA. 221+68

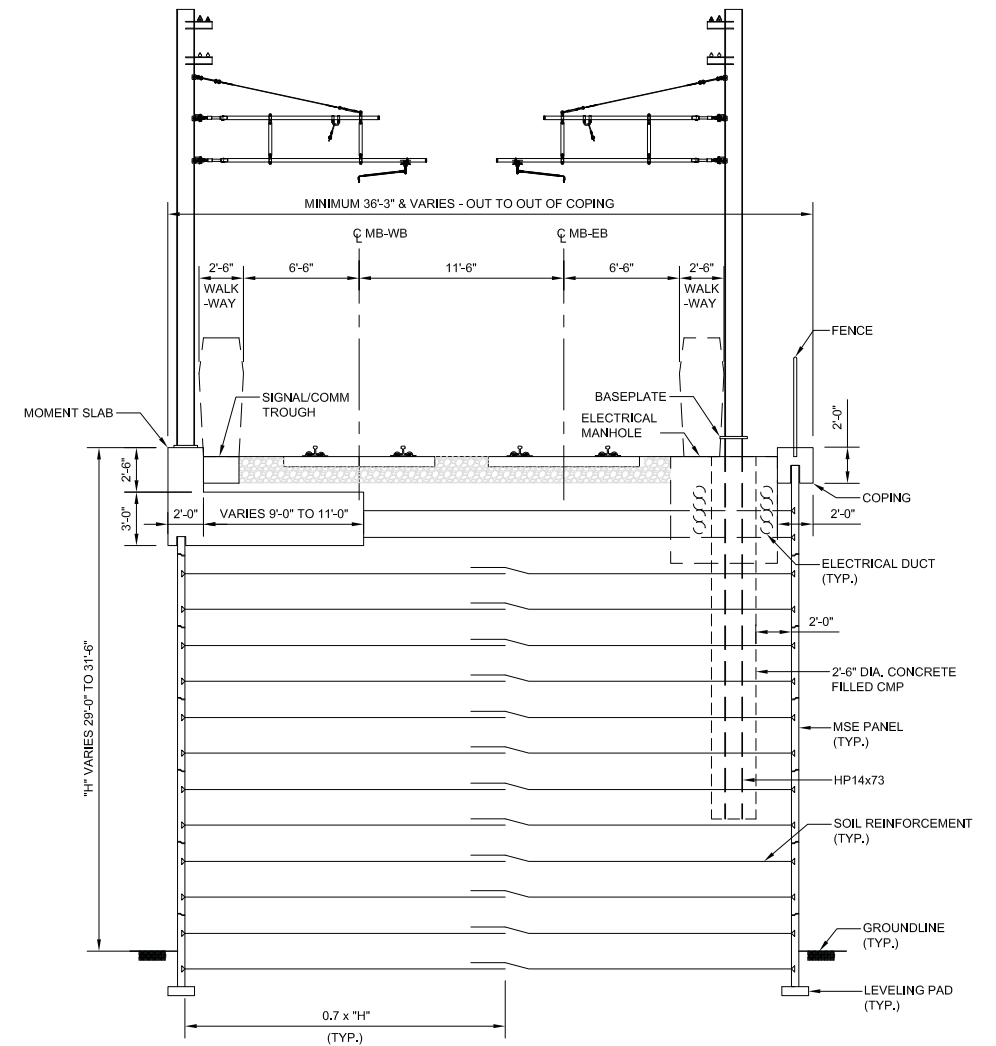

SECTION

3/16"=1'-0" 0 3' 6' 12'
 DOUBLE TRACK WITH OCS POLES
 STA. 201+24 TO STA. 204+25

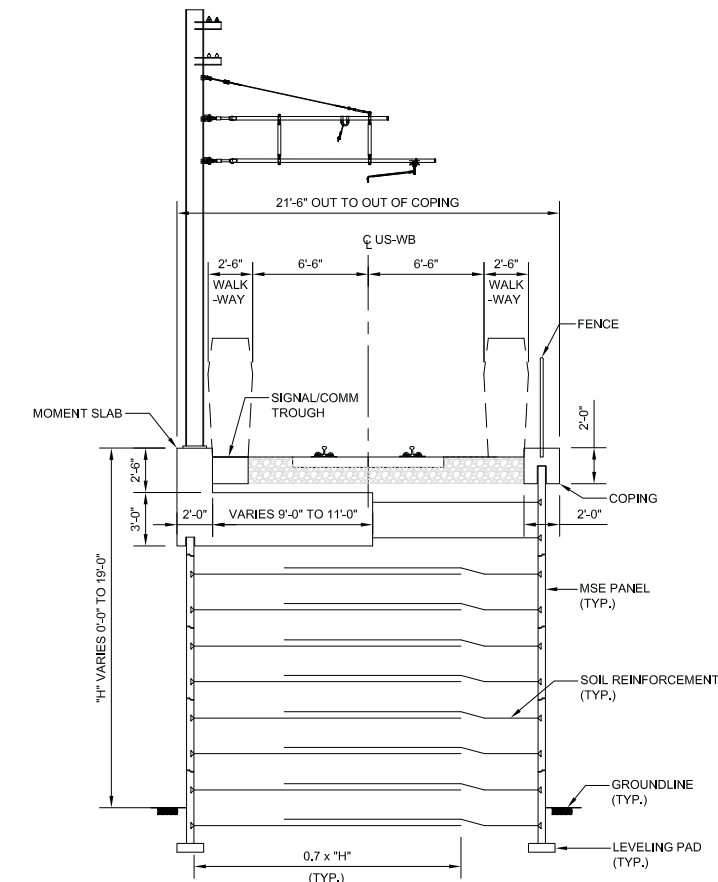



SECTION

3/16"=1'-0" 0 3' 6' 12'
 SINGLE TRACK WITH OCS POLES ON MOMENT SLAB
 STA. 10+90 TO STA. 11+30 (US-EB)
 STA. 9+31 TO STA. 11+47 (US-WB)

PROPOSAL
 MASSACHUSETTS BAY TRANSPORTATION AUTHORITY

 GREEN LINE EXTENSION PROJECT
 MBTA CONTRACT NO. E22CN04
 CAMBRIDGE/SOMERVILLE, MASSACHUSETTS

**ATC 35
 TYPICAL SECTION**

					
SCALE: AS NOTED	DRAWN BY: DM	DESIGN BY: STB	CHECK BY: SB	PLAN NO. .	ISSUE
DATE: SEPT. 28, 2017				SHEET: S-017	
ISSUE	DATE	DESCRIPTION	BY	CHKD	APP.

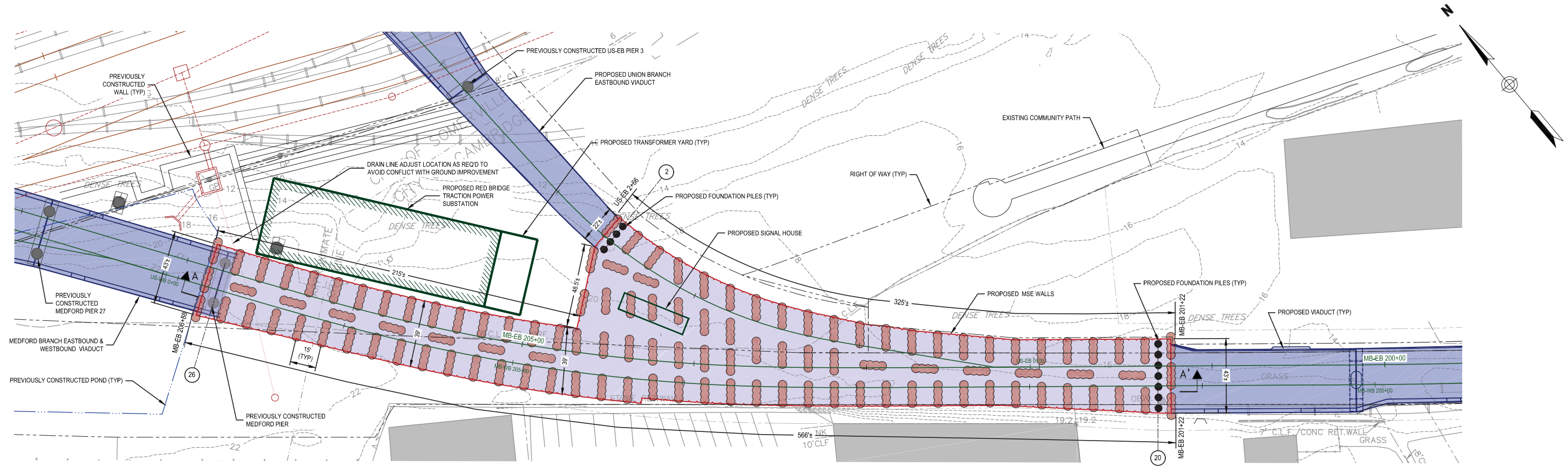

GROUND IMPROVEMENT PLAN

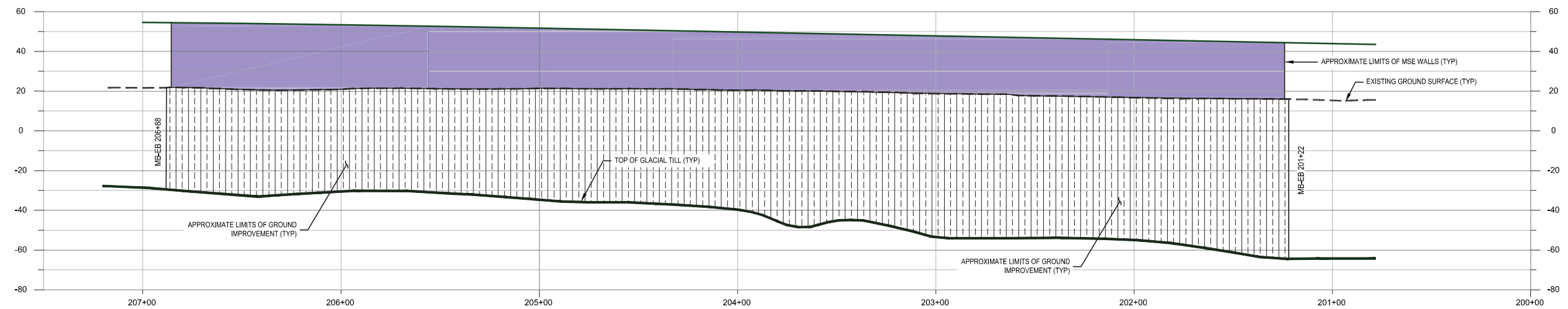

**PROFILE A-A' MEDFORD BRANCH
(MB-EB 200+00 TO 207+00)**

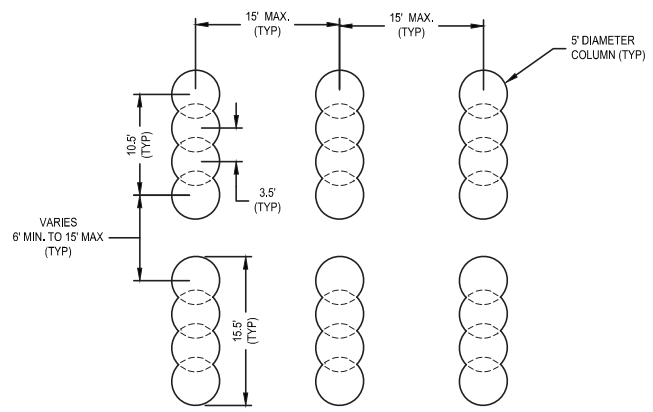

TYPICAL LAYOUT



PROPOSAL

MASSACHUSETTS BAY TRANSPORTATION AUTHORITY
 GREEN LINE EXTENSION PROJECT
 MBTA CONTRACT NO. E22CN04
 CAMBRIDGE/SOMERVILLE, MASSACHUSETTS

**ATC 35
GROUND IMPROVEMENT
AT MSE WALLS**

SCALE: AS NOTED	DRAWN BY: DL	DESIGN BY: STS	CHECK BY: RJP	PLAN NO.	ISSUE
DATE: SEPT. 28, 2017				SHEET: S-018	

PLOTTED: 09/29/17 11:44AM BY: REBEKAH.LANDI
 DRAWING: \\GZANDRE\REFS\2018\01_P000061_18R_P\FIGURES\CAD\GZA-GROUND IMPROVEMENT-BASE.DWG (GROUND IMPROV) 09/22/17 9:48AM

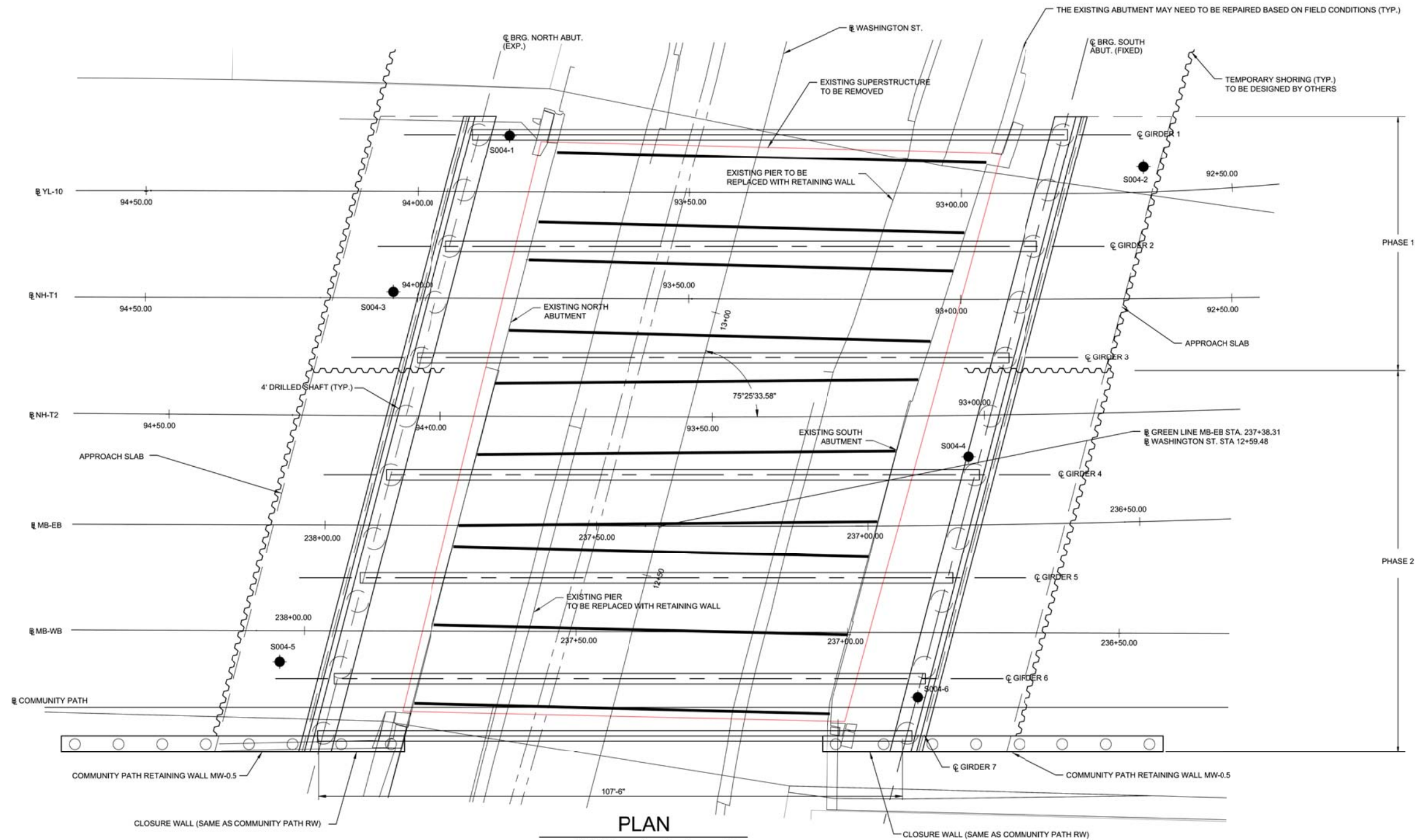

NOTES:

STRUCTURAL STEEL
ALL STRUCTURAL STEEL SHALL CONFORM TO ASTM A709, GRADE 50, PAINTED, UNLESS OTHERWISE NOTED.

CAST-IN-PLACE CONCRETE
ALL CAST-IN-PLACE CONCRETE SHALL BE IN ACCORDANCE WITH THE SPECIFIED MINIMUM COMPRESSIVE STRENGTH (f_c) AND CONCRETE CLASS AT 28 DAYS.

f_c = 4000 PSI, 3/8" MAX. AGGREGATE FOR ABUTMENTS, WINGWALLS, BACKWALLS, STATION ENTRANCE CAP, AND WASHINGTON STREET WALLS.

f_c = 4000 PSI, 3/4" MAX. AGGREGATE FOR APPROACH SLABS.

f_c = 4000 PSI, 3/8", CEMENT CONCRETE FOR DRILLED SHAFTS. THE CLEAR SPACING BETWEEN STEEL REINFORCING BARS SHALL BE AT LEAST 17#8"

REINFORCING STEEL
REINFORCING STEEL SHALL CONFORM TO THE REQUIREMENTS OF ASTM DESIGNATION A706, GRADE 60.

BEARINGS
BEARINGS SHALL BE 14 EA ELASTOMERIC BEARINGS PLACED AT THE CENTER OF THEIR RESPECTIVE GIRDER.

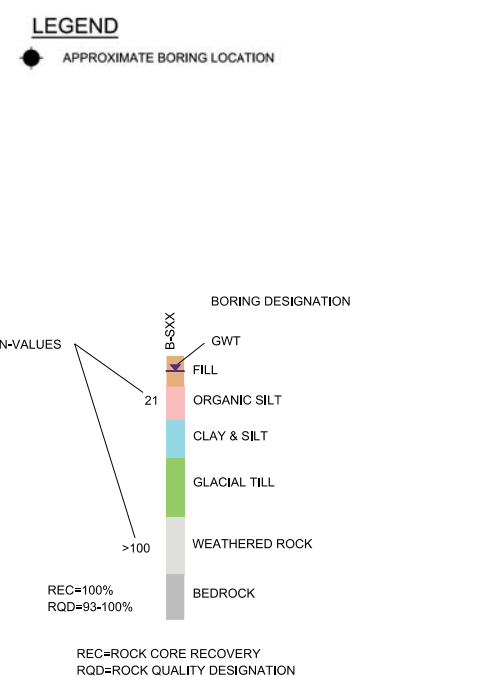

PLAN

3/32"=1'-0"

0 4' 8' 16'

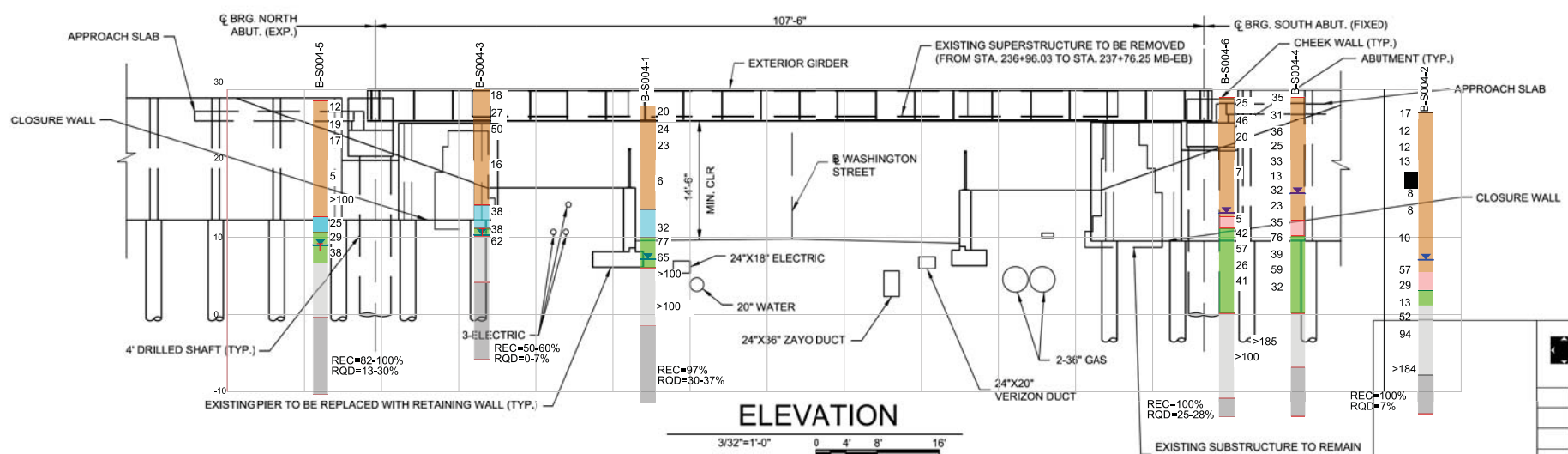

ELEVATION

3/32"=1'-0"

0 4' 8' 16'

PROPOSAL

MASSACHUSETTS BAY TRANSPORTATION AUTHORITY

T

GREEN LINE EXTENSION PROJECT
MBTA CONTRACT NO. E22CN04
CAMBRIDGE/SOMERVILLE, MASSACHUSETTS

**WASHINGTON STREET BRIDGE
PLAN & ELEVATION**

STV 100 Years		massDOT Massachusetts Department of Transportation		GLX CONSTRUCTORS	
SCALE: AS NOTED	DRAWN BY: SM	DESIGN BY: JY	CHECK BY: AR	PLAN NO.	ISSUE
DATE: SEPT. 28, 2017	BY: SM	CHKD: JY	APP: AR	SHEET: S-019	
ISSUE	DATE	DESCRIPTION	BY	CHKD	APP.

Ton Bridge CP&E Print - Proposal.dwg

NOTES:

1. THE EXISTING SPAN SHALL BE TEMPORARILY SUPPORTED AT THE SOUTH ABUTMENT TO ALLOW FOR THE RECONSTRUCTION OF THE ABUTMENT CAP TO RECEIVE THE NEW SPAN.
2. THE NH-T1, NH-T2, MB-EB AND THE MB-WB ALIGNMENTS SHOWN IN THIS DRAWING ARE ALTERNATE PROPOSED REALIGNMENTS TO PROVIDE ADEQUATE HORIZONTAL CLEARANCES WITH RESPECT TO UNDERPASS SUBSTRUCTURE ELEMENTS.
3. REMOVE EXISTING ENDPOST, MODIFY ENDS OF PROTECTIVE SCREEN AND EXTEND OVER NEW SPAN.
4. USE STRIP SEAL JOINT FOR ADDITIONAL INFORMATION AND STANDARD DETAILS, REFER TO MASSDOT LRFD BRIDGE MANUAL, PART II, SECTIONS 10.2.1, TO 10.2.16.
5. UTILITY BRIDGE PIERS THAT INTERFERE WITH THE PROPOSED TRACK ALIGNMENT SHALL BE REMOVED AND NEW UTILITY BRIDGE SUPPORTS SHALL BE CONSTRUCTED.

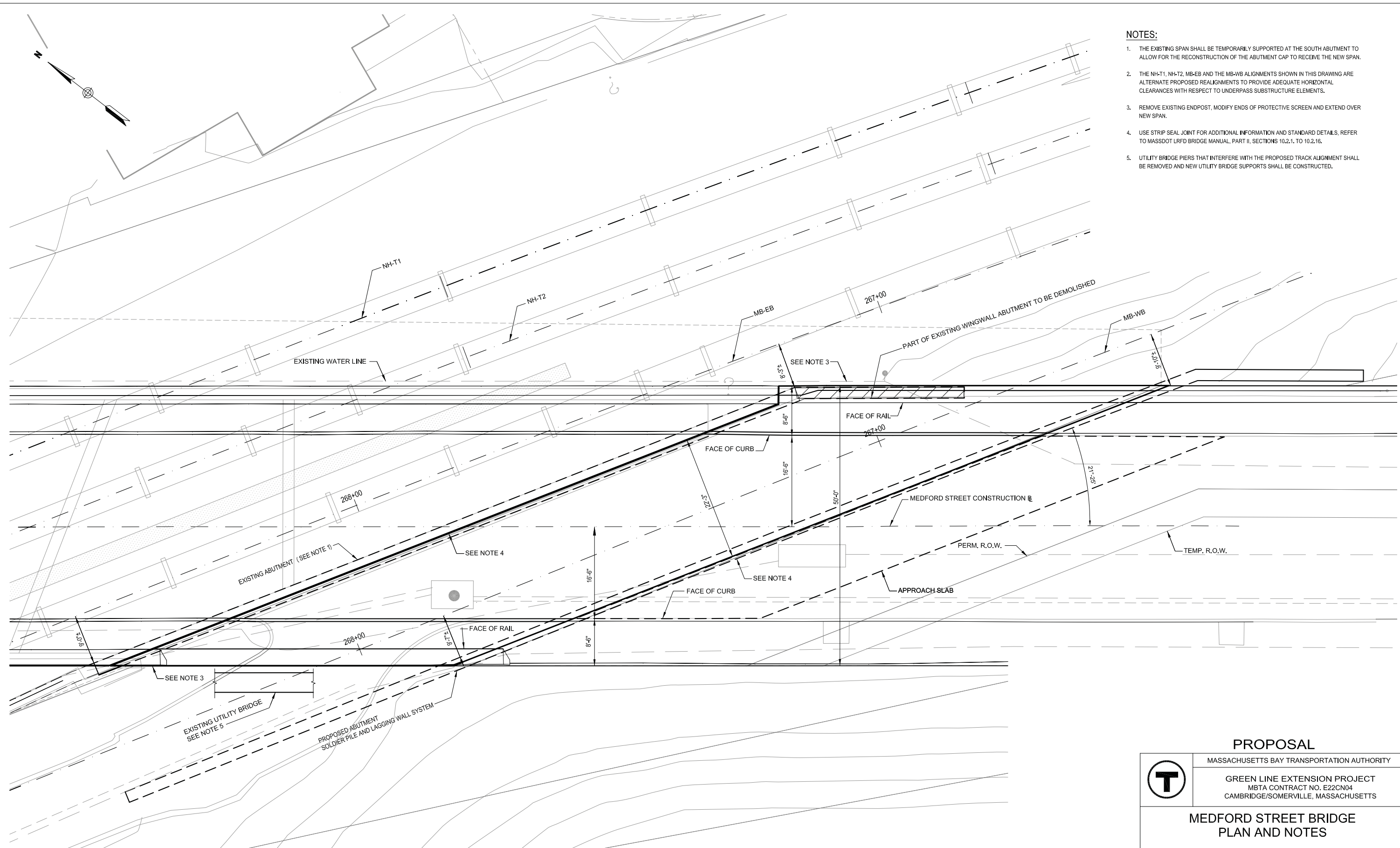

PLOTTED: 08/29/17 8:14 AM BY: JAKED
 DRAWING: I:\PROJECTS\GLX\TECH DESIGN\BRIDGES\PROPOSAL DRAWINGS\MEDFORD_ST PROPOSAL.DWG [SHEET 01 - PLAN] 09/21/17 11:34 AM

MEDFORD STREET BRIDGE PLAN
 1/8"=1'-0"
 0 4' 8' 16'

PROPOSAL
 MASSACHUSETTS BAY TRANSPORTATION AUTHORITY
 GREEN LINE EXTENSION PROJECT
 MBTA CONTRACT NO. E22CN04
 CAMBRIDGE/SOMERVILLE, MASSACHUSETTS

**MEDFORD STREET BRIDGE
 PLAN AND NOTES**

SCALE: 1/8"=1'-0"	DRAWN BY: SMH	DESIGN BY: GEE	CHECK BY: JM	PLAN NO.	ISSUE
DATE: SEPT. 28, 2017				SHEET: S-021	
ISSUE	DATE	DESCRIPTION	BY	CHKD	APP.

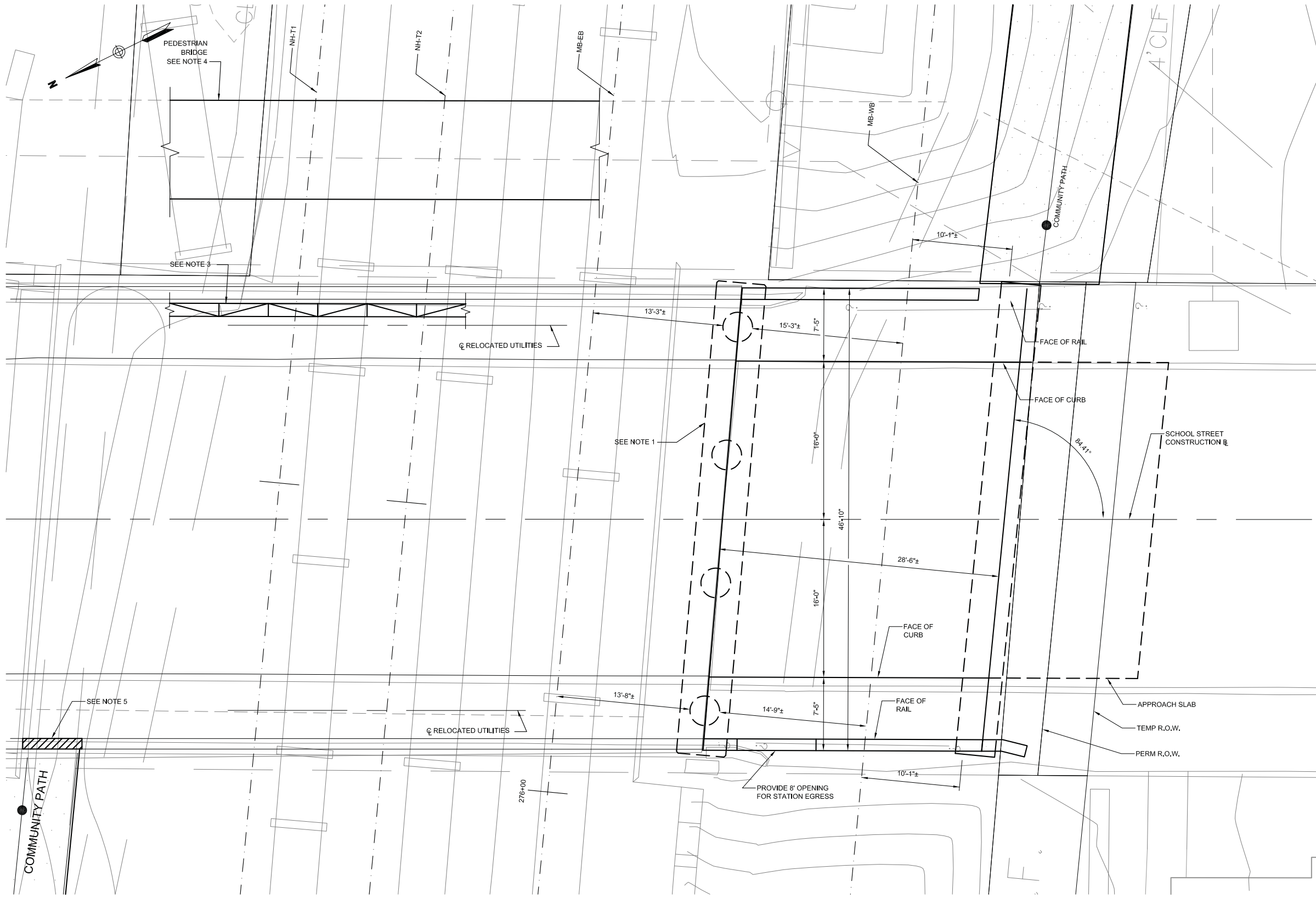

NOTES:

1. THE EXISTING SPAN SHALL BE TEMPORARILY SUPPORTED AT THE SOUTH ABUTMENT TO ALLOW FOR THE DEMOLITION OF THE ABUTMENT AND THE CONSTRUCTION OF NEW PIER TO RECEIVE THE NEW SPAN.
2. USE STRIP SEAL JOINT. FOR ADDITIONAL INFORMATION AND STANDARD DETAILS REFER TO MASSDOT LRFD BRIDGE MANUAL, PART II, SECTIONS 10.2.1. TO 10.2.16.
3. THE EXISTING TRUSS SUPPORTING UTILITIES ON THE SIDEWALK OF THE EXISTING BRIDGE SHALL BE REMOVED AND THE EXISTING SIDEWALK REPAIRED.
4. THE UTILITIES ON THE PEDESTRIAN BRIDGE SHALL BE MOVED TO THE VEHICULAR BRIDGE. THIS PEDESTRIAN BRIDGE SHALL BE DEMOLISHED.
5. REMOVE EXISTING CONCRETE BARRIER AND FENCE TO PROVIDE 12' OPENING FOR COMMUNITY PATH.

SCHOOL STREET BRIDGE PLAN

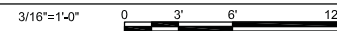

PROPOSAL

MASSACHUSETTS BAY TRANSPORTATION AUTHORITY



GREEN LINE EXTENSION PROJECT
MBTA CONTRACT NO. E22CN04
CAMBRIDGE/SOMERVILLE, MASSACHUSETTS

**SCHOOL STREET BRIDGE
PLAN AND NOTES**



GV20170258-272.pdf

SCALE: 3/16"=1'-0"	DRAWN BY: DEH	DESIGN BY: GEE	CHECK BY: JM	PLAN NO.	ISSUE
DATE: SEPT. 28, 2017	DEH	GEE	JM	SHEET: S-023	

PLOTTED: 08/29/17 8:47AM BY: HART
 DRAWING: I:\PROPOSALS\GLX\TECH DESIGN\BRIDGES\PROPOSAL DRAWINGS\SCHOOL_ST_PROPOSAL.DWG [S-023 - PLAN] 09/21/17 11:56AM

NOTES:

1. THE EXISTING SPAN SHALL BE TEMPORARILY SUPPORTED AT THE SOUTH ABUTMENT TO ALLOW FOR THE DEMOLITION OF THE ABUTMENT AND THE CONSTRUCTION OF A NEW PIER TO RECEIVE THE NEW SPAN.
2. NEW MULTICOLUMN PIER.
3. PROVIDE OCS PROTECTIVE BOARD BELOW UTILITIES. SEE SYSTEM DRAWINGS FOR DETAILS.

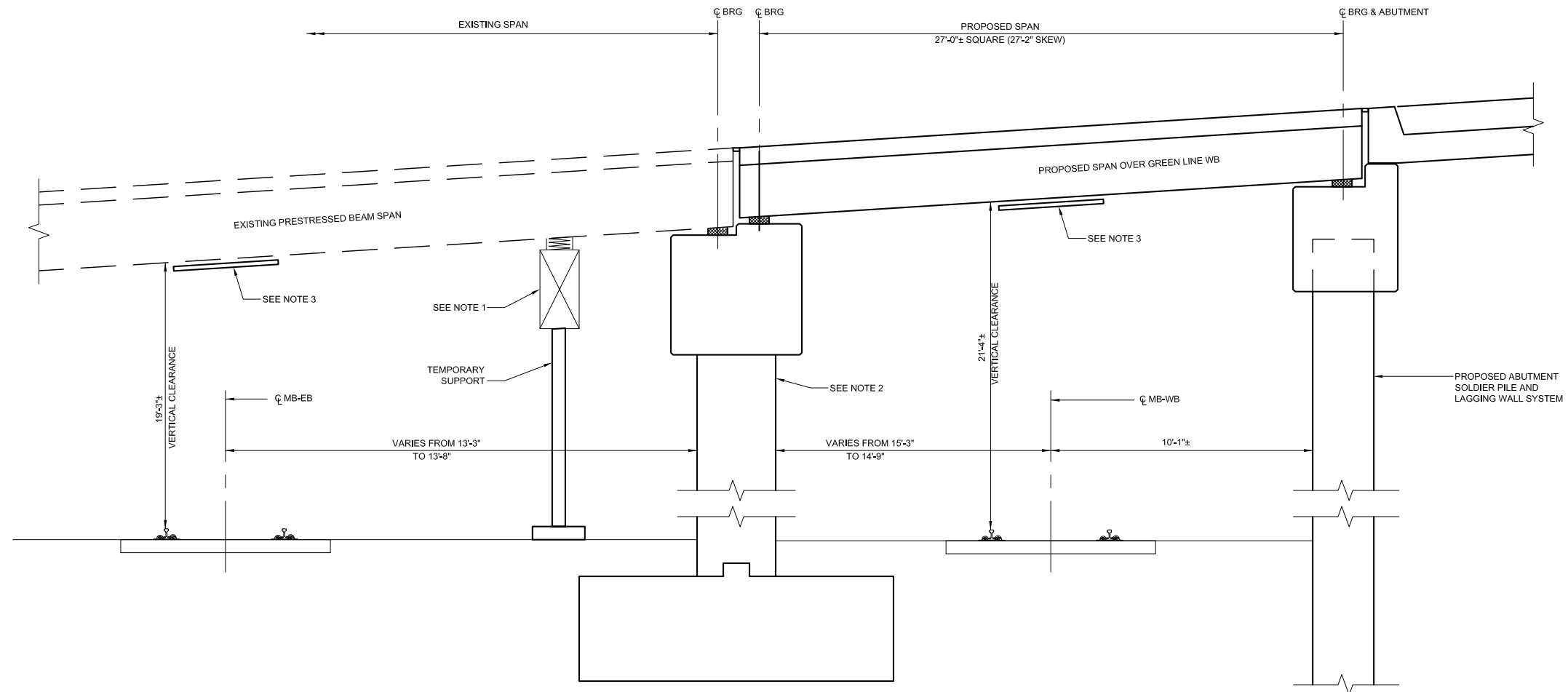

SCHOOL STREET BRIDGE ELEVATION

3/8"=1'-0" 0 2' 4' 6'

PLOTTED: 09/21/17 9:58AM BY: HART
 DRAWING: I:\PROJECTS\GLX\TECH DESIGN\BRIDGES\PROPOSAL DRAWINGS\SCHOOL_ST PROPOSAL DWG [S-027 - ELEVATION] 09/21/17 11:56AM

PROPOSAL

MASSACHUSETTS BAY TRANSPORTATION AUTHORITY

GREEN LINE EXTENSION PROJECT
 MBTA CONTRACT NO. E22CN04
 CAMBRIDGE/SOMERVILLE, MASSACHUSETTS

SCHOOL STREET BRIDGE ELEVATION

			GV20170258-272.pdf
SCALE: AS NOTED	DRAWN BY: DEH	DESIGN BY: GEE	CHECK BY: JM
DATE: SEPT. 28, 2017	PLAN NO.	SHEET: S-024	ISSUE
ISSUE DATE DESCRIPTION BY CHKD APP.			

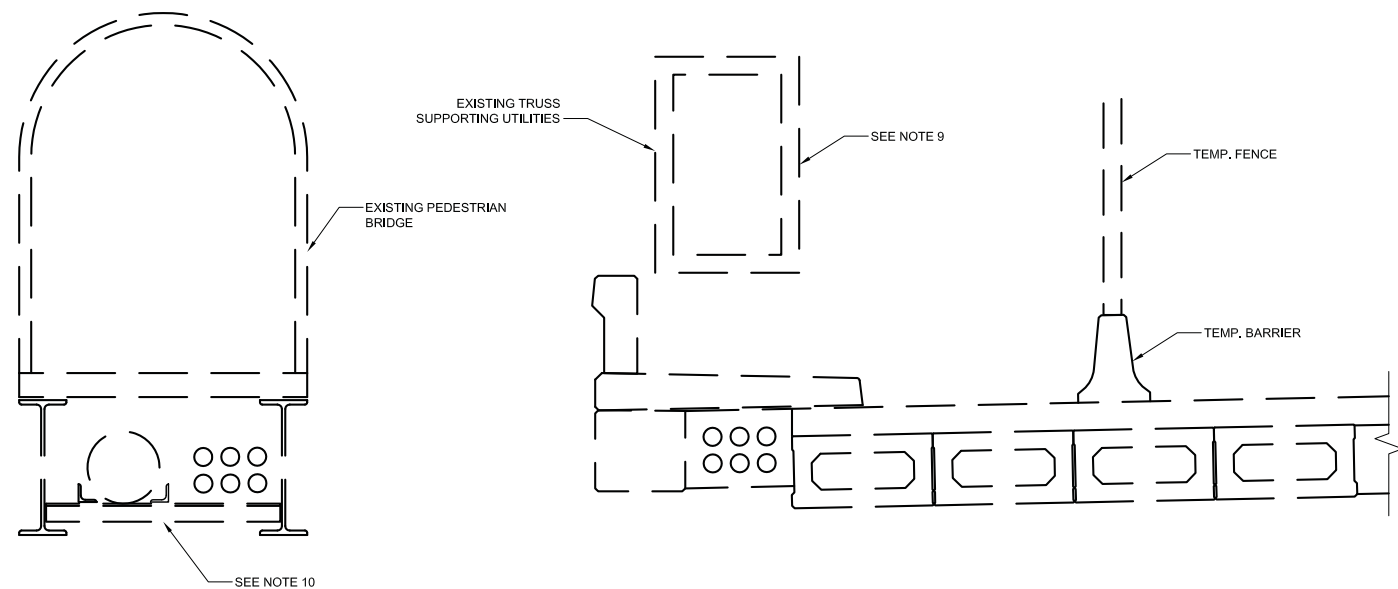

CROSS SECTION AT EXISTING SPAN

3/8"=1'-0" 0 2' 4' 6'

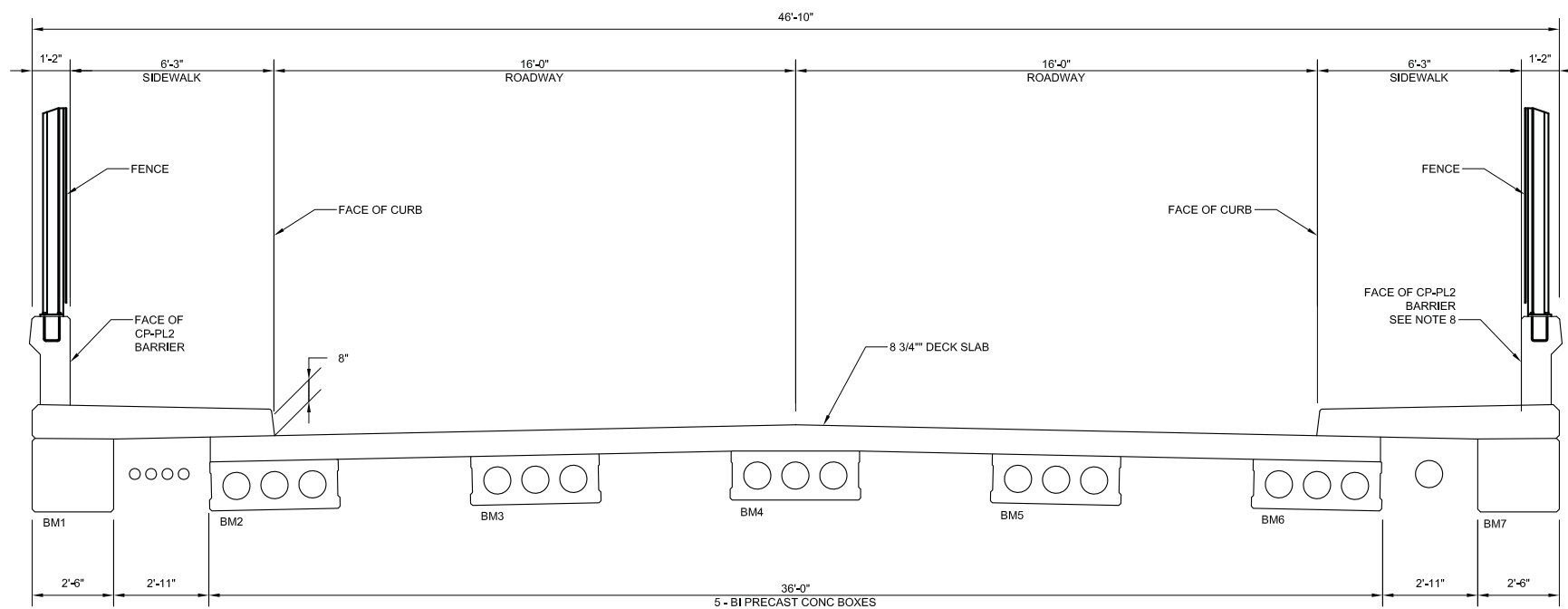

TYPICAL BRIDGE SECTION PRECAST CONCRETE DECK BEAM OPTION

3/8"=1'-0" 0 2' 4' 6'

NOTES:

1. CONCRETE IN THE BRIDGE DECK SHALL HAVE A MINIMUM 28 DAY COMPRESSION STRENGTH OF 4,000 PSI, WITH A MAXIMUM AGGREGATE SIZE OF 3/4", AND 585 PCY CEMENT CONTENT.
2. BARRIERS, SIDEWALK AND SAFETY CURB CONCRETE SHALL HAVE A MINIMUM 28 DAY COMPRESSION STRENGTH OF 5,000 PSI, WITH A MAXIMUM AGGREGATE SIZE OF 3/4" AND 685 HP CEMENT CONCRETE.
3. CONCRETE IN DECK BEAMS SHALL HAVE A MINIMUM 28 DAY COMPRESSION STRENGTH OF 6,500 PSI. NO PRESTRESSED SHALL BE TRANSFERRED TO THE CONCRETE UNTIL IT HAS ATTAINED A MINIMUM COMPRESSIVE STRENGTH OF AT LEAST 4,500 PSI.
4. ALL REINFORCING STEEL SHALL BE DEFORMED AND SHALL BE COATED TO CONFORM TO AASHTO M 31, GRADE 60.
5. PRESTRESSING STRANDS SHALL BE 0.6" DIAMETER, UNCOATED, SEVEN-WIRE, LOW-RELAXATION STEEL STRANDS CONFORMING TO AASHTO M 203, GRADE 270.
6. VOIDS IN THE DECK BEAMS SHALL TERMINATE 3'-9" FROM END OF SPAN AND 7' ON EITHER SIDE OF THE TRANSVERSE TENDON CENTERLINE AT MIDSPAN. THE TOP OF ALL BEAMS SHALL RECEIVE A RAKE FINISH.
7. USE CP-PL2 RAILING / BARRIER. REFER TO MASSDOT LRFD BRIDGE MANUAL, PART II, SECTIONS 9.4.1 TO 9.4.3.
8. BRIDGE DECK SHALL BE GROOVED TRANSVERSELY USING MULTI-BLADED, SELF-PROPELLED SAWCUTTING EQUIPMENT.
9. THE EXISTING TRUSS SUPPORTING UTILITIES ON THE SIDEWALK OF THE EXISTING BRIDGE SHALL BE REMOVED AND THE EXISTING SIDEWALK REPAIRED.
10. THE UTILITIES ON THE PEDESTRIAN BRIDGE SHALL BE MOVED TO THE VEHICULAR BRIDGE. THIS PEDESTRIAN BRIDGE SHALL BE DEMOLISHED.

PLOTTED: 09/20/17 9:58AM BY: HART
 DRAWING: I:\PROPOSALS\GLX\TECH DESIGN\BRIDGES\PROPOSAL DRAWINGS\SCHOOL_ST PROPOSAL DWG [S-025 - TRANSVERSE SECTION] 09/21/17 11:56AM

PROPOSAL

MASSACHUSETTS BAY TRANSPORTATION AUTHORITY

T

GREEN LINE EXTENSION PROJECT
 MBTA CONTRACT NO. E22CN04
 CAMBRIDGE/SOMERVILLE, MASSACHUSETTS

**SCHOOL STREET BRIDGE
 CROSS SECTIONS**

		SCALE: AS NOTED DATE: SEPT. 28, 2017	DRAWN BY: DEH DESIGN BY: GEE CHECK BY: JM	PLAN NO. SHEET: S-025	ISSUE
ISSUE	DATE	DESCRIPTION	BY	CHKD	APP.

GV20170258-272.pdf



CEDAR STREET BRIDGE PLAN

3/32"=1'-0" 0 6' 12' 24'

NOTES:

1. THE EXISTING WINGWALL AT THE SOUTHEAST CORNER OF THE BRIDGE SHALL BE DEMOLISHED, AND A NEW WINGWALL SHALL BE CONSTRUCTED
2. SAFETY NICHES 1'-10" DEEP X 2'-0" WIDE X 7'-0" HEIGHT SPACED 20'-0" O.C. SHALL BE FORMED IN THE EXISTING SOUTH ABUTMENT STEM. SEE DETAIL THIS SHEET.

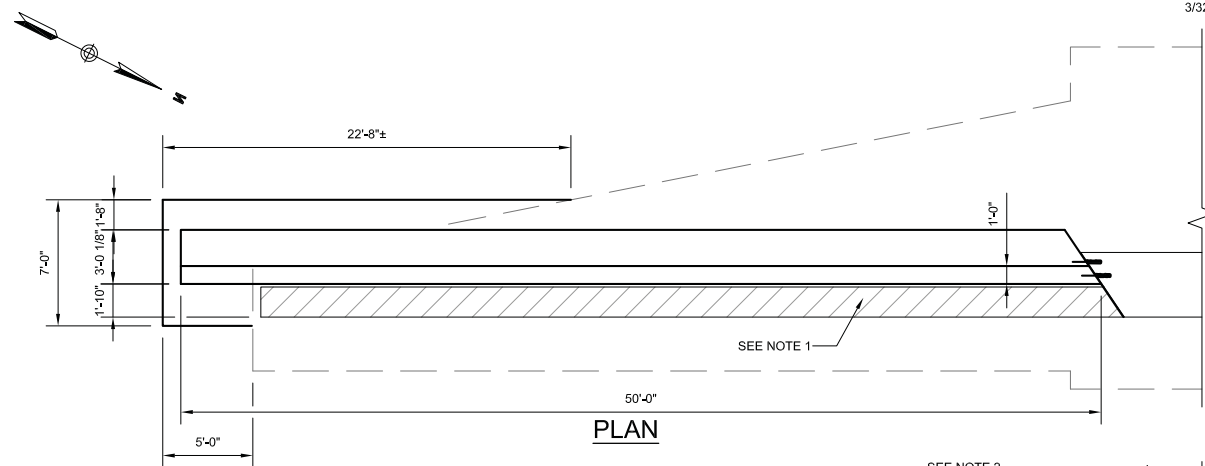

PLAN

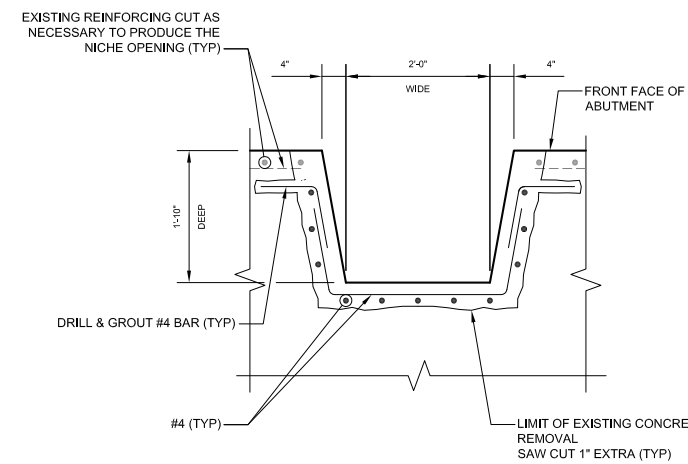

REFUGE NICHE DETAIL

3/4"=1'-0" 0 1' 2' 3'

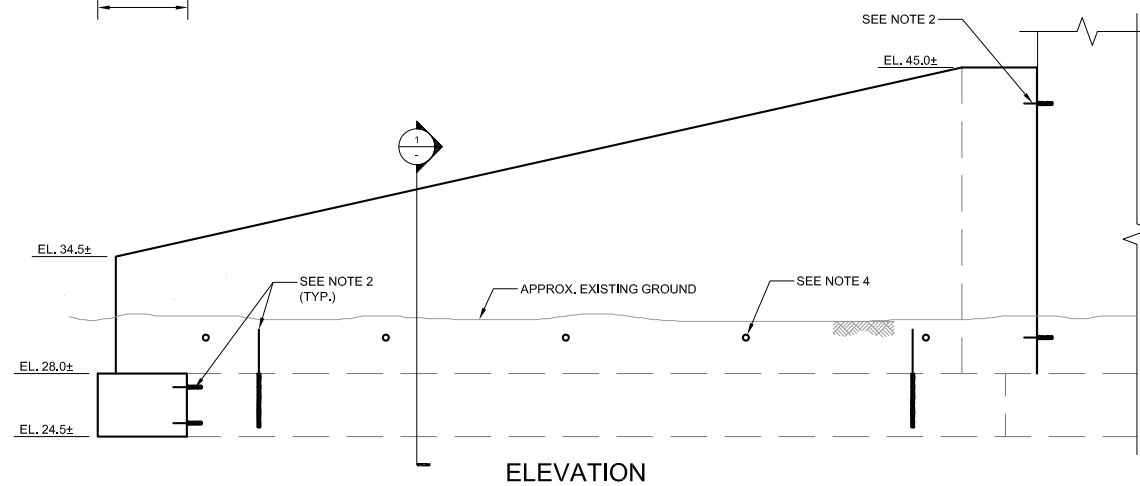

ELEVATION

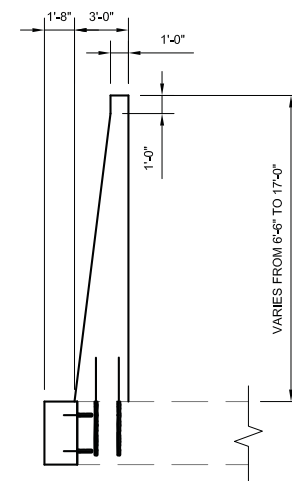

SECTION 1

CEDAR STREET BRIDGE WINGWALL DETAILS

3/16"=1'-0" 0 3' 6' 12'

PLOTTED: 09/28/17 10:01AM BY: JHET
 DRAWING: I:\PROPOSALS\GLX\TECH DESIGN\BRIDGES\PROPOSAL DRAWINGS\CEDAR_ST_PROPOSAL.DWG [SHEET 01 - PLAN] 09/08/17 4:40PM

PROPOSAL

MASSACHUSETTS BAY TRANSPORTATION AUTHORITY



GREEN LINE EXTENSION PROJECT
 MBTA CONTRACT NO. E22CN04
 CAMBRIDGE/SOMERVILLE, MASSACHUSETTS

**CEDAR STREET BRIDGE
 PLAN AND ELEVATION**



GV20170258-272.pdf

ISSUE	DATE	DESCRIPTION	BY	CHKD	APP.	SCALE:	DRAWN BY:	DESIGN BY:	CHECK BY:	PLAN NO.	ISSUE
						AS NOTED	DEH	GEE	JM		
	SEPT. 28, 2017									S-026	

PLOTTED: 09/29/17 10:02AM BY: HART
 DRAWING: I:\PROPOSALS\GLX\TECH DESIGN\BRIDGES\PROPOSAL DRAWINGS\LOWELL_ST_PROPOSAL.DWG [SHEET 01 - PLAN] 09/21/17 11:58AM

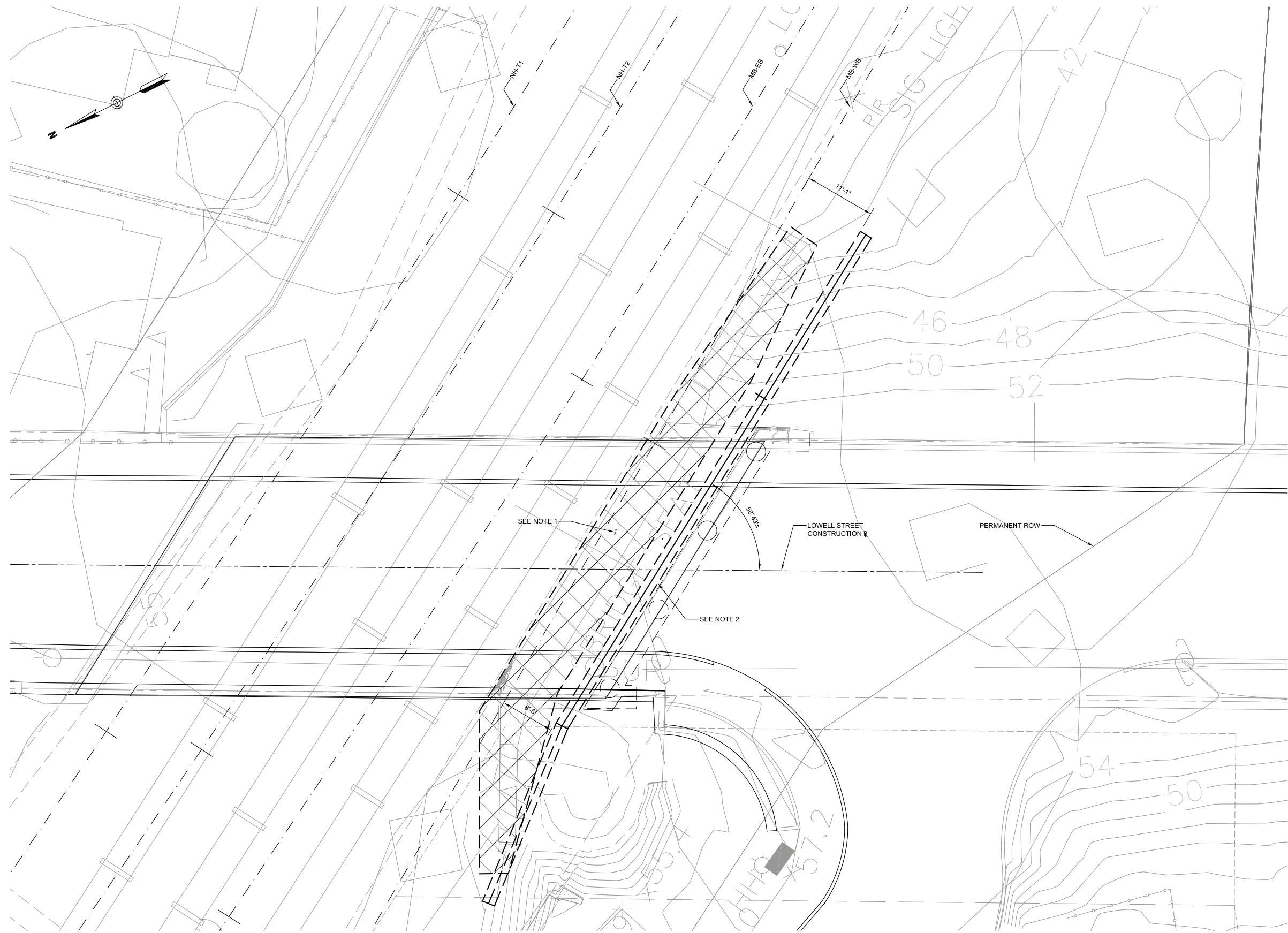

- NOTES:**
- EXISTING STONE MASONRY SOUTH ABUTMENT SHALL BE DEMOLISHED TO PROVIDE ADEQUATE HORIZONTAL CLEARANCE TO MB-EB AND MB-WB.
 - A RETAINING WALL SYSTEM SHALL BE PROVIDED IN FRONT OF EXISTING DRILLED SHAFT AND CAP AT THE SOUTH ABUTMENT.

LOWELL STREET BRIDGE PLAN



PROPOSAL

MASSACHUSETTS BAY TRANSPORTATION AUTHORITY
 GREEN LINE EXTENSION PROJECT
 MBTA CONTRACT NO. E22CN04
 CAMBRIDGE/SOMERVILLE, MASSACHUSETTS

**LOWELL STREET BRIDGE
PLAN AND GENERAL NOTES**

SCALE: 1/8"=1'-0"	DRAWN BY: DEH	DESIGN BY: GEE	CHECK BY: JM	PLAN NO. SHEET: S-027	ISSUE
-------------------	---------------	----------------	--------------	-----------------------	-------

ISSUE	DATE	DESCRIPTION	BY	CHKD	APP.

NOTES:

- EXISTING STONE MASONRY SOUTH ABUTMENT SHALL BE DEMOLISHED TO PROVIDE ADEQUATE HORIZONTAL CLEARANCE FROM CL OF MB-EB AND MB-WB.
- A RETAINING WALL SYSTEM SHALL BE PLACE IN FRONT OF THE EXISTING DRILLED SHAFT AND CAP AT THE SOUTH ABUTMENT.
- CONFIGURATION AND NUMBER OF TIE-BACKS TO BE DETERMINED BY VENDOR, THE POSSIBLE INTERFERENCE WITH THE EXISTING TIE-BACK SYSTEM FOR THE EXISTING BRIDGE S-17-015 AND RETAINING WALLS AT THE SOUTH ABUTMENT SHALL BE INVESTIGATED.
- PROVIDE OCS PROTECTION BOARD BELOW UTILITIES. SEE SYSTEM DRAWINGS FOR DETAILS.

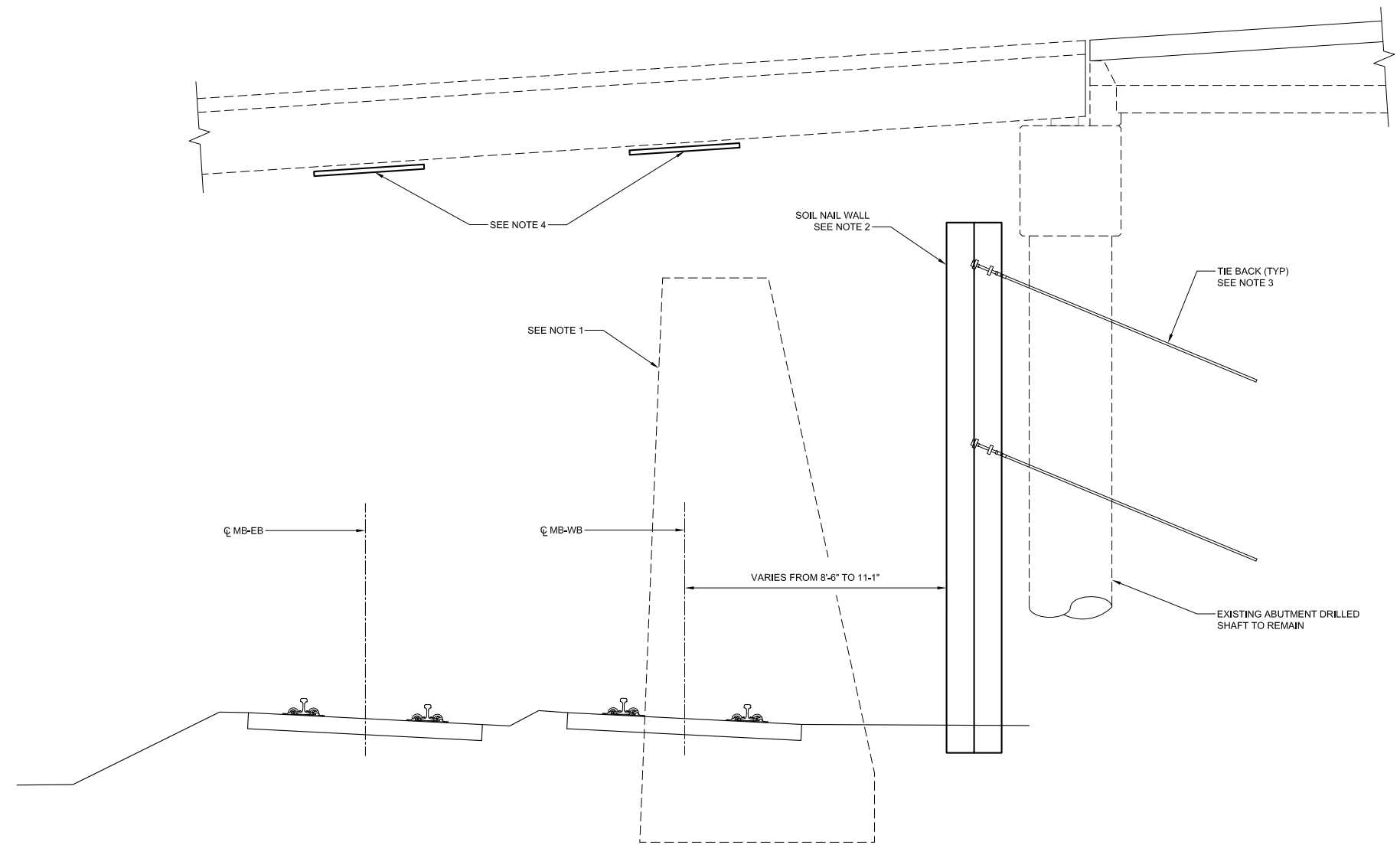
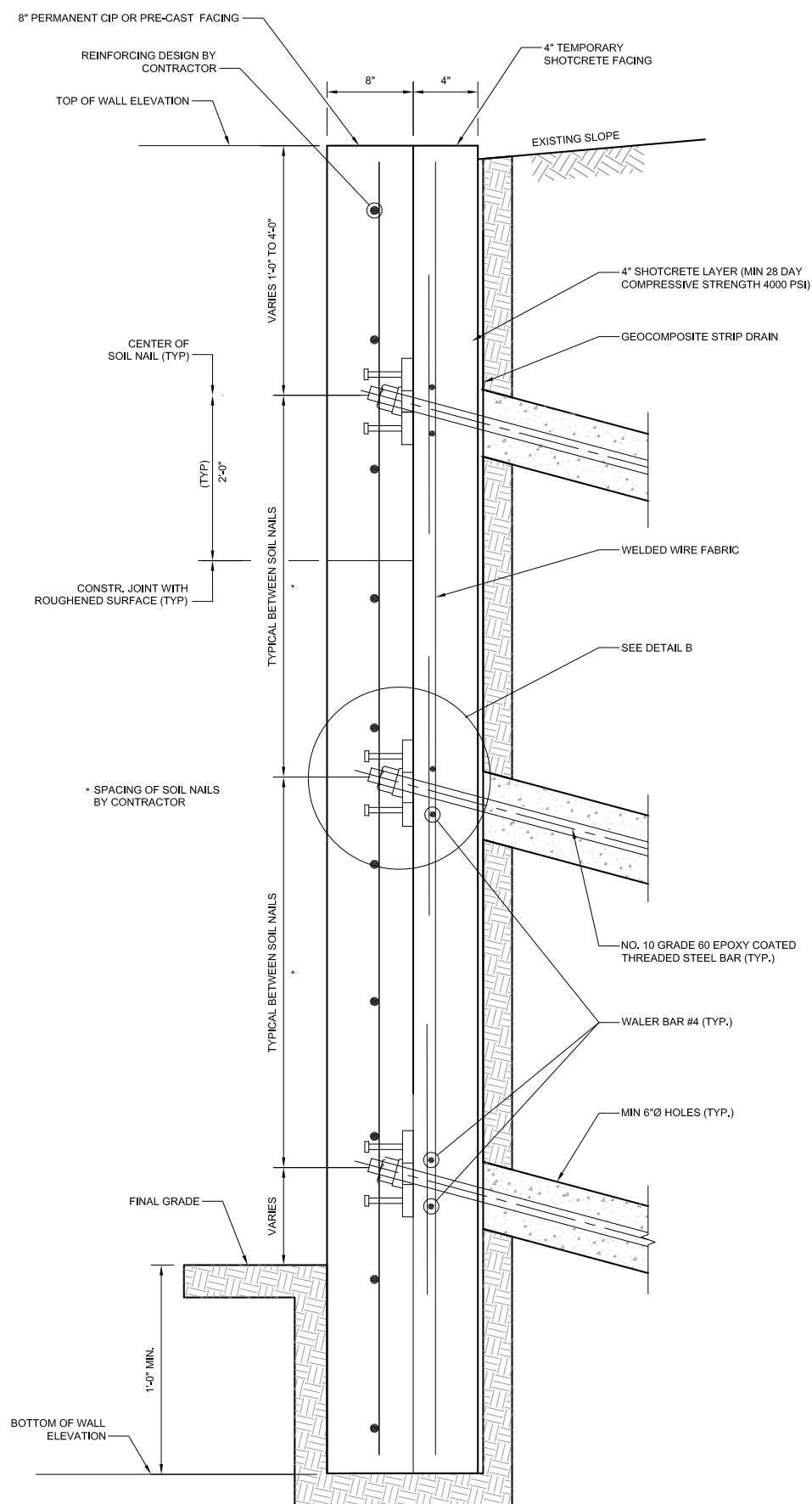

LOWELL STREET BRIDGE ELEVATION

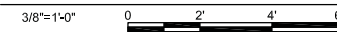

ALTERNATE GROUTED SOIL NAIL WALL TYPICAL SECTION

NOT TO SCALE

PROPOSAL
 MASSACHUSETTS BAY TRANSPORTATION AUTHORITY
 GREEN LINE EXTENSION PROJECT
 MBTA CONTRACT NO. E22CN04
 CAMBRIDGE/SOMERVILLE, MASSACHUSETTS

LOWELL STREET BRIDGE ELEVATION

SCALE: AS NOTED	DRAWN BY: DEH	DESIGN BY: GEE	CHECK BY: JM	PLAN NO.	ISSUE
DATE: SEPT. 28, 2017				SHEET: S-028	

PLOTTED: 09/28/17 10:03AM BY: HARTD
 DRAWING: I:\PROPOSALS\GLX\TECH DESIGN\BRIDGES\PROPOSAL DRAWINGS\LOWELL_ST PROPOSAL DWG [SHEET 02 - ELEVATION] 09/21/17 11:58AM

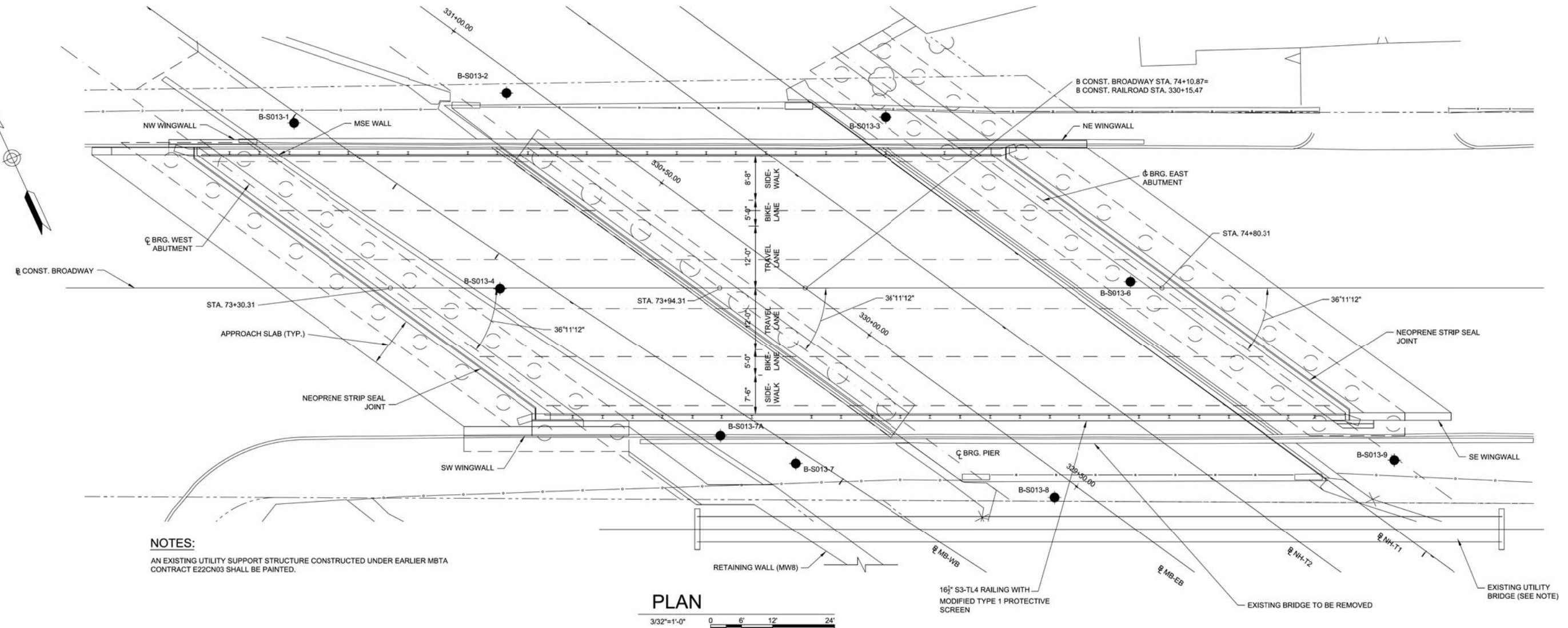

NOTES:
AN EXISTING UTILITY SUPPORT STRUCTURE CONSTRUCTED UNDER EARLIER MBTA CONTRACT E22CN03 SHALL BE PAINTED.

PLAN
3/32"=1'-0"
0 6' 12' 24'

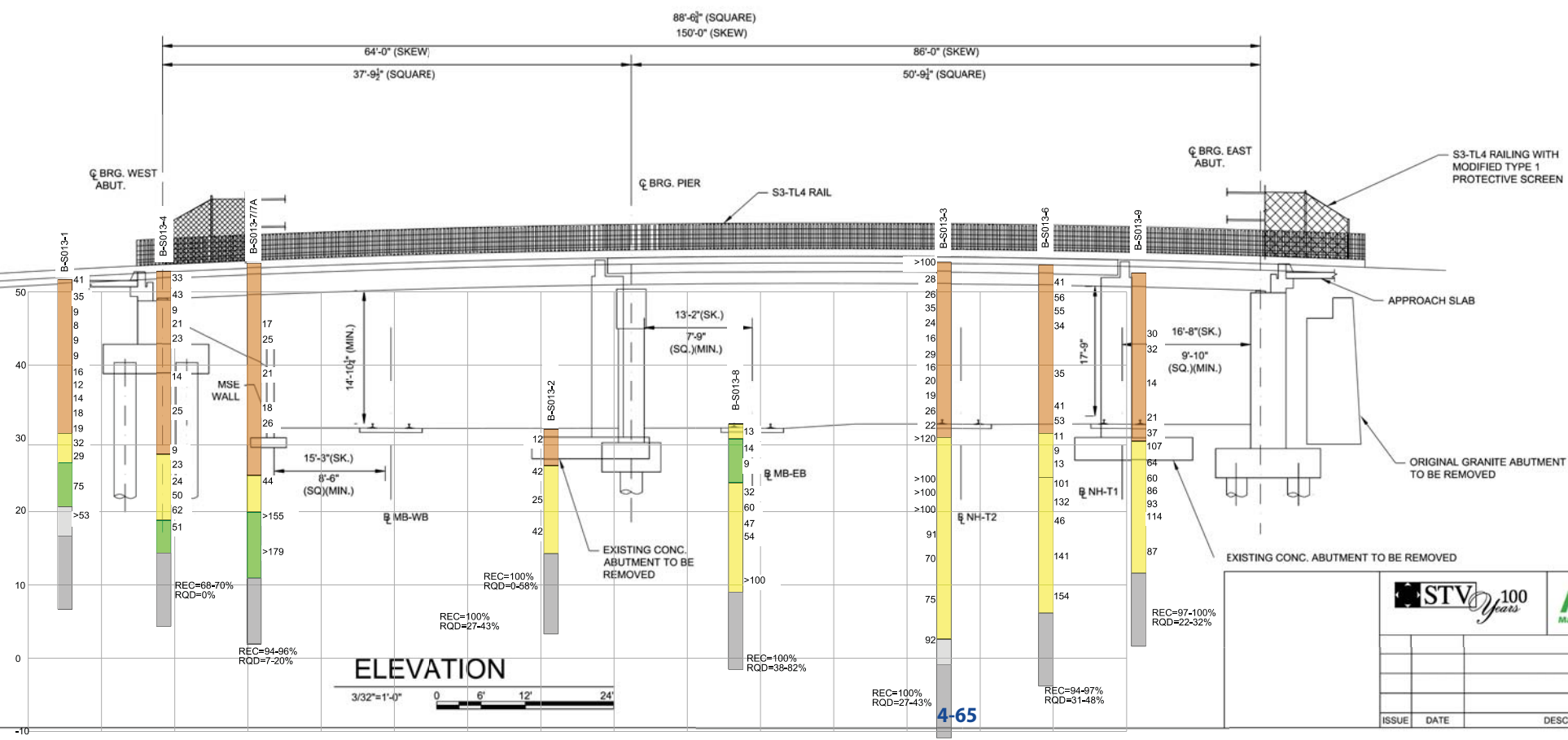

ELEVATION
3/32"=1'-0"
0 6' 12' 24'

LEGEND

- APPROXIMATE BORING LOCATION
- B-SXX BORING DESIGNATION
- GWT GROUND WATER TABLE
- ORGANICS/FILL
- SAND
- CLAY, SILT & TILL
- WEATHERED ROCK
- BEDROCK
- REC=ROCK CORE RECOVERY
- RQD=ROCK QUALITY DESIGNATION
- REC=100% RQD=93-100%
- >100

PROPOSAL
MASSACHUSETTS BAY TRANSPORTATION AUTHORITY
T
GREEN LINE EXTENSION PROJECT
MBTA CONTRACT NO. E22CN04
CAMBRIDGE/SOMERVILLE, MASSACHUSETTS

BROADWAY BRIDGE PLAN & ELEVATION

STV 100 Years
massDOT Massachusetts Department of Transportation
GLX CONSTRUCTORS

SCALE: AS NOTED
DRAWN BY: SP
DESIGN BY: AR
CHECK BY: AC
DATE: SEPT. 28, 2017
PLAN NO.:
SHEET: S-029

ISSUE

Friday, September 22, 2017 AT 11:51 AM
P:\Projects\Projects\Green Line Extension DB - MassDOT\Broadway St. Bridge\CP&E\Broadway - Proposed.dwg

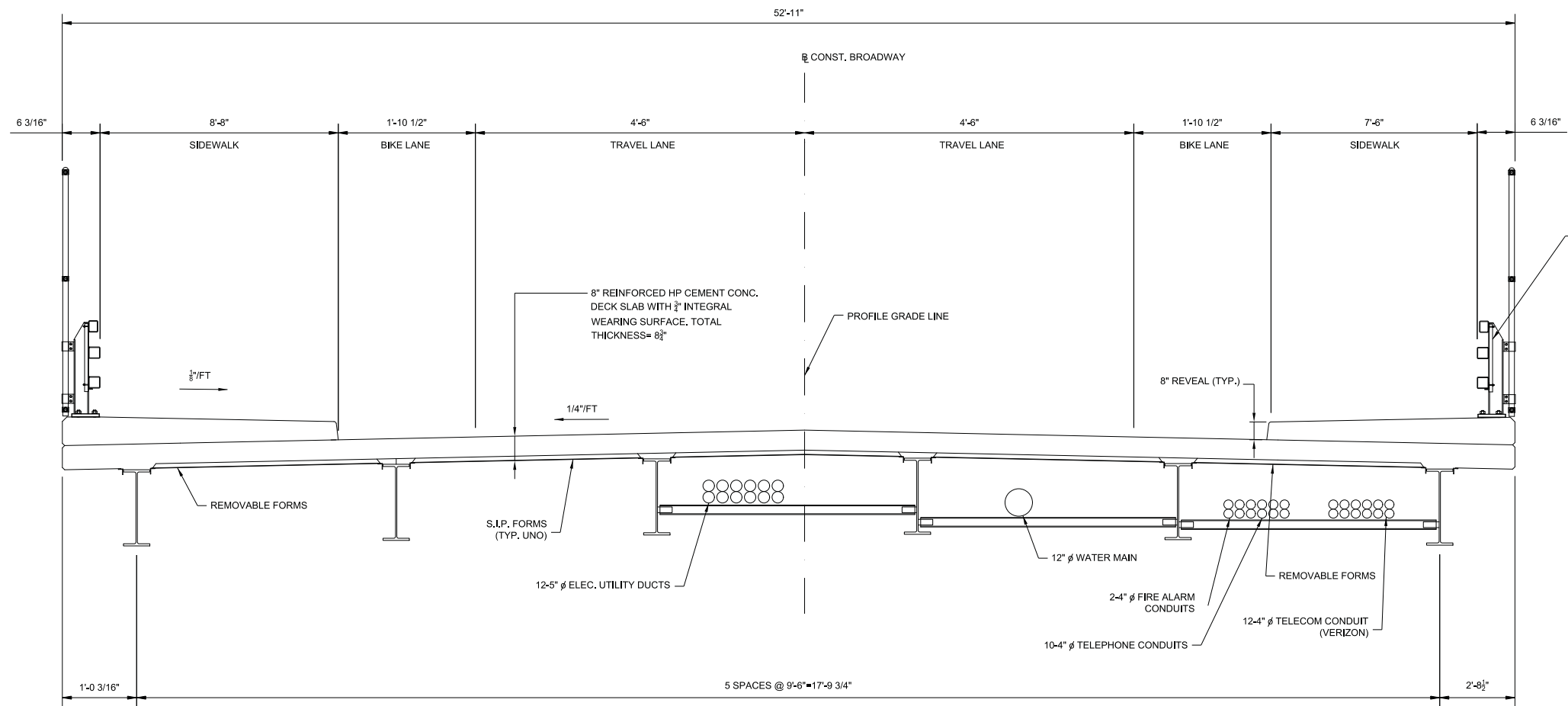

TRANSVERSE SECTION
 3/8"=1'-0"
 0 2' 4' 6'

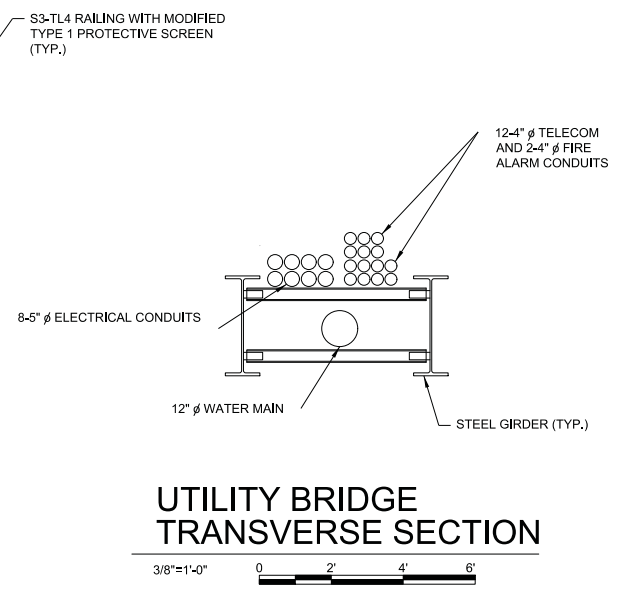

UTILITY BRIDGE TRANSVERSE SECTION
 3/8"=1'-0"
 0 2' 4' 6'

Friday, September 22, 2017 11:52 AM
 P:\Projects\Green Line Extension DB - MassDOT\Broadway St. Bridge\Typical Section_Print - Proposal.dwg

PROPOSAL

MASSACHUSETTS BAY TRANSPORTATION AUTHORITY

GREEN LINE EXTENSION PROJECT
 MBTA CONTRACT NO. E22CN04
 CAMBRIDGE/SOMERVILLE, MASSACHUSETTS

BROADWAY BRIDGE
 TYPICAL TRANSVERSE SECTION

		GV20170258-272.pdf			
SCALE: AS NOTED	DRAWN BY: SP	DESIGN BY: AR	CHECK BY: AC	PLAN NO.	ISSUE
DATE: SEPT. 28, 2017				SHEET: S-030	
ISSUE	DATE	DESCRIPTION	BY	CHKD	APP.

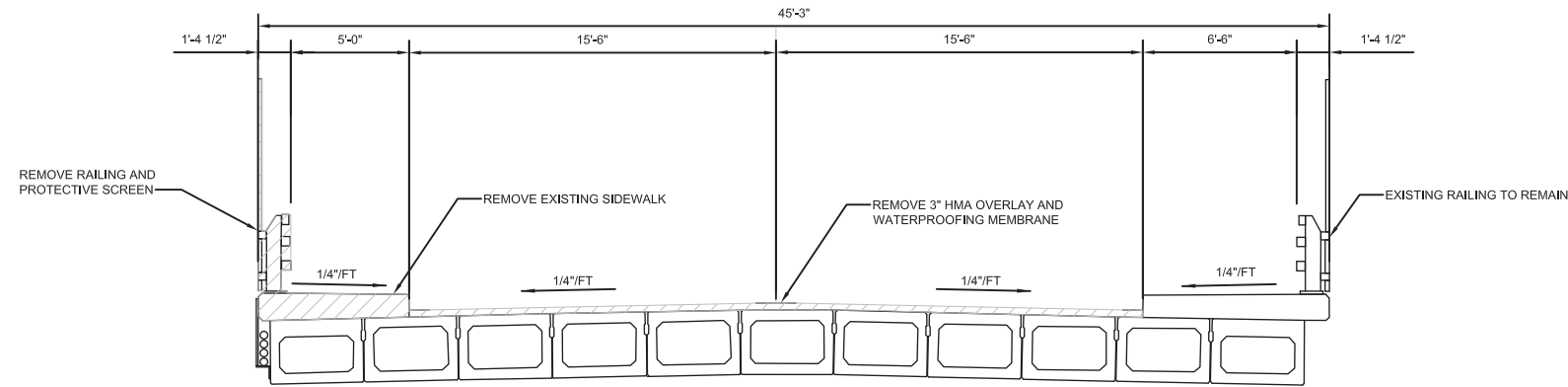

TYPICAL SECTION - REMOVAL

NOT TO SCALE

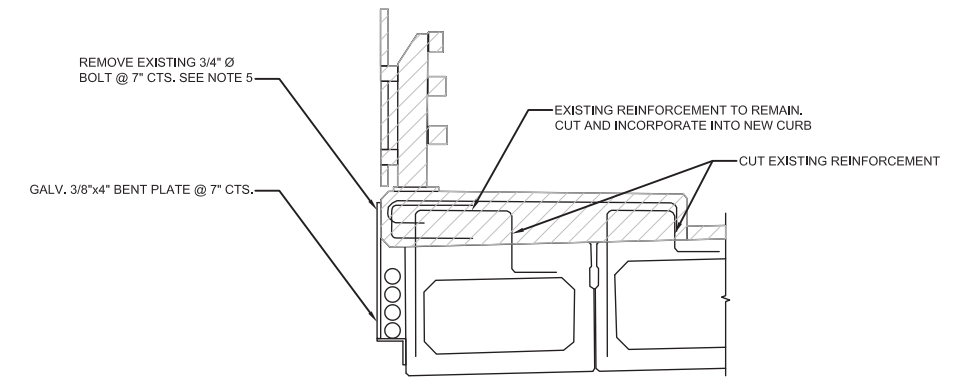

SECTION THRU SIDEWALK

NOT TO SCALE

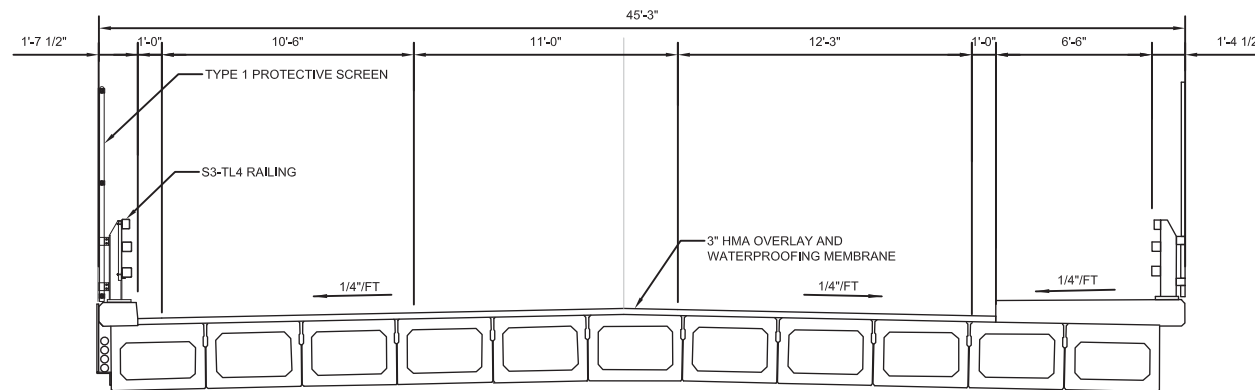

TYPICAL SECTION - PROPOSED

NOT TO SCALE

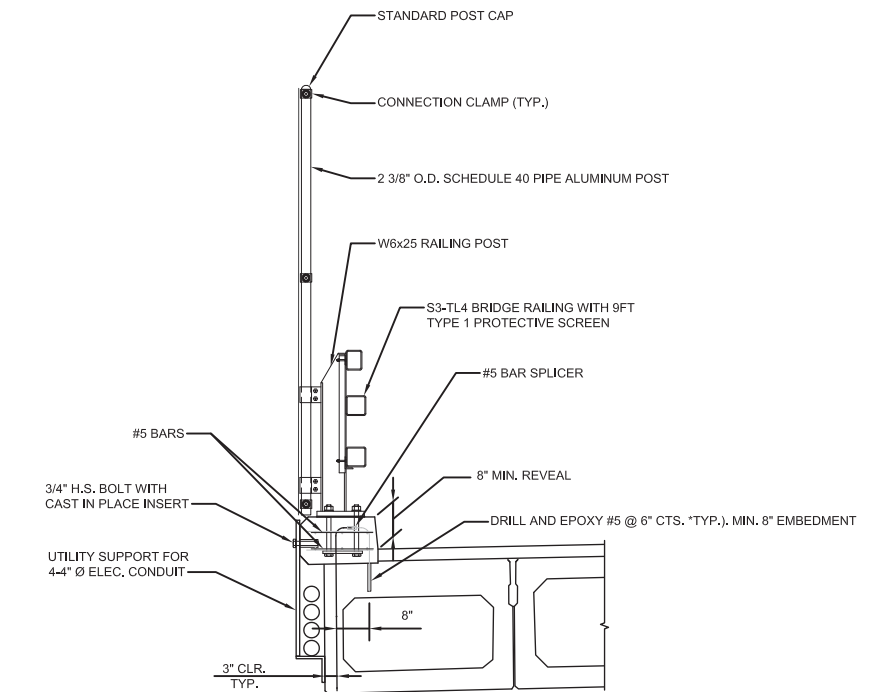

SECTION THRU SAFETY CURB

NOT TO SCALE

NOTES:

1. CONTRACTOR SHALL USE PACHOMETER TO LOCATE AND MARK EXISTING REINFORCING BEFORE DRILLING ANCHORS INTO EXISTING BEAMS.
2. SIDEWALK CONCRETE SHALL BE 5000 PSI, 3/4" 635 SILICA FUME MODIFIED CEMENT CONCRETE.
3. SIDEWALK AND CURB REINFORCING SHALL BE EPOXY COATED.
4. TEMPORARILY SUPPORT EXISTING UTILITIES AS REQUIRED TO COMPLETE WORK.

PROPOSAL



MASSACHUSETTS BAY TRANSPORTATION AUTHORITY
GREEN LINE EXTENSION PROJECT
 MBTA CONTRACT NO. E22CN04
 CAMBRIDGE/SOMERVILLE, MASSACHUSETTS

**COLLEGE AVENUE BRIDGE
 TYPICAL SECTIONS**



GV20170258-272.pdf

SCALE: N.T.S.	DRAWN BY: JMP	DESIGN BY: JMP	CHECK BY: SB	PLAN NO. .	ISSUE
DATE: SEPT. 28, 2017				SHEET: S-031	

PLOTTED: 09/22/17 2:25PM BY: PATTI.SAM
 DRAWING: I:\PROPOSALS\2017\0062820 GLX D-B\STV 2017 RFP DESIGN\90_CAD MODELS AND SHEETS\04_CL_BRIDGE\COLLEGE_AVE HIGHWAY BRIDGE\FINAL_S-51.DWG [S-51] 09/22/17 1:35PM

PLOTTED: 09/22/17 2:18PM BY: PATTISMA
 DRAWING: I:\PROPOSALS\2017\0062620.GX D-B\STV 2017 RFP DESIGN\90_CAD MODELS AND SHEETS\VA_CJ_BRIDGE\COLLEGE_AVE_PED_BRIDGE_FINAL[S-032].DWG [S-032] 09/22/17 2:18PM

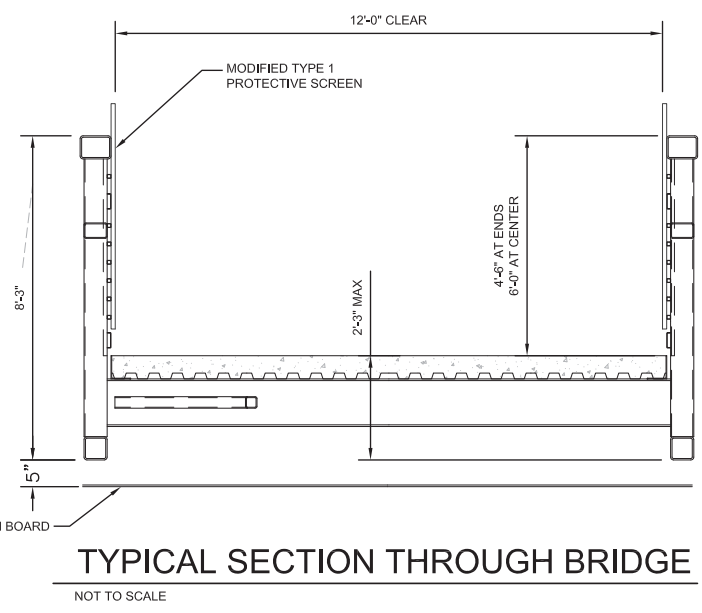
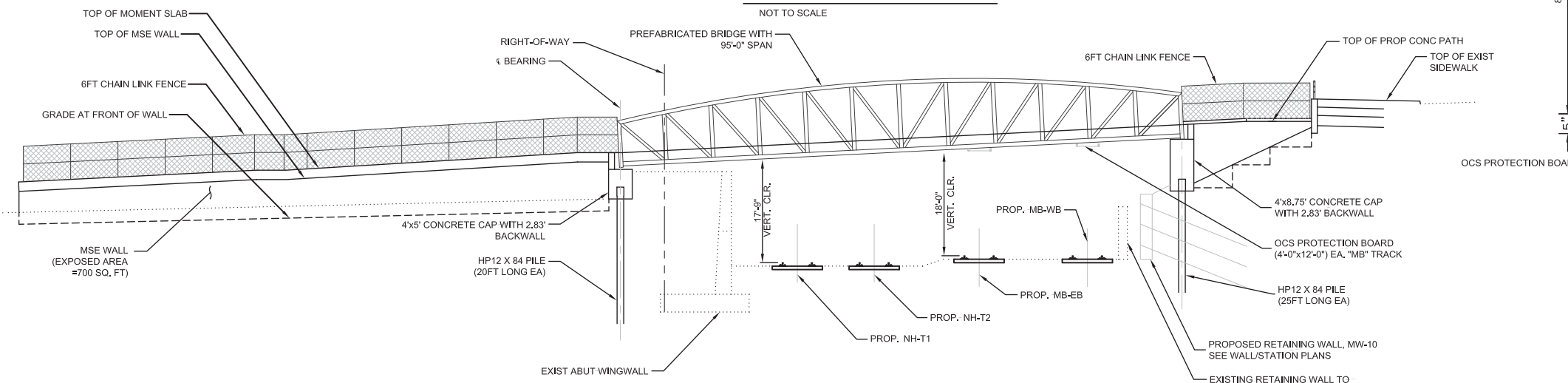
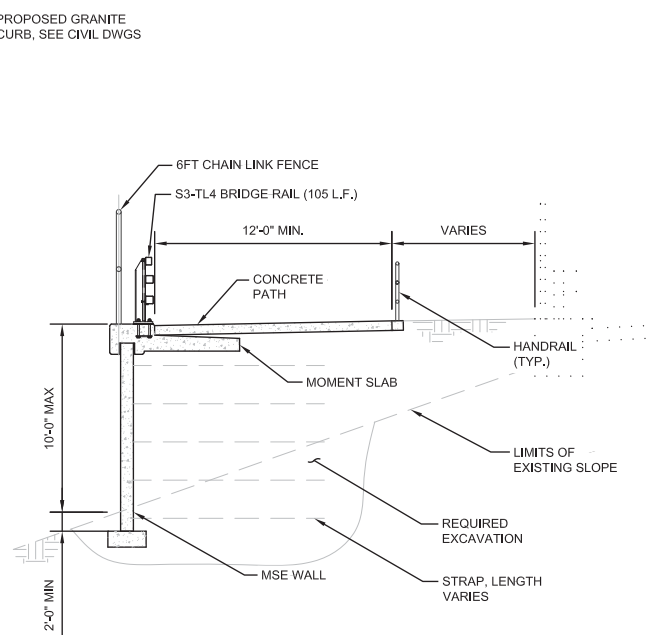
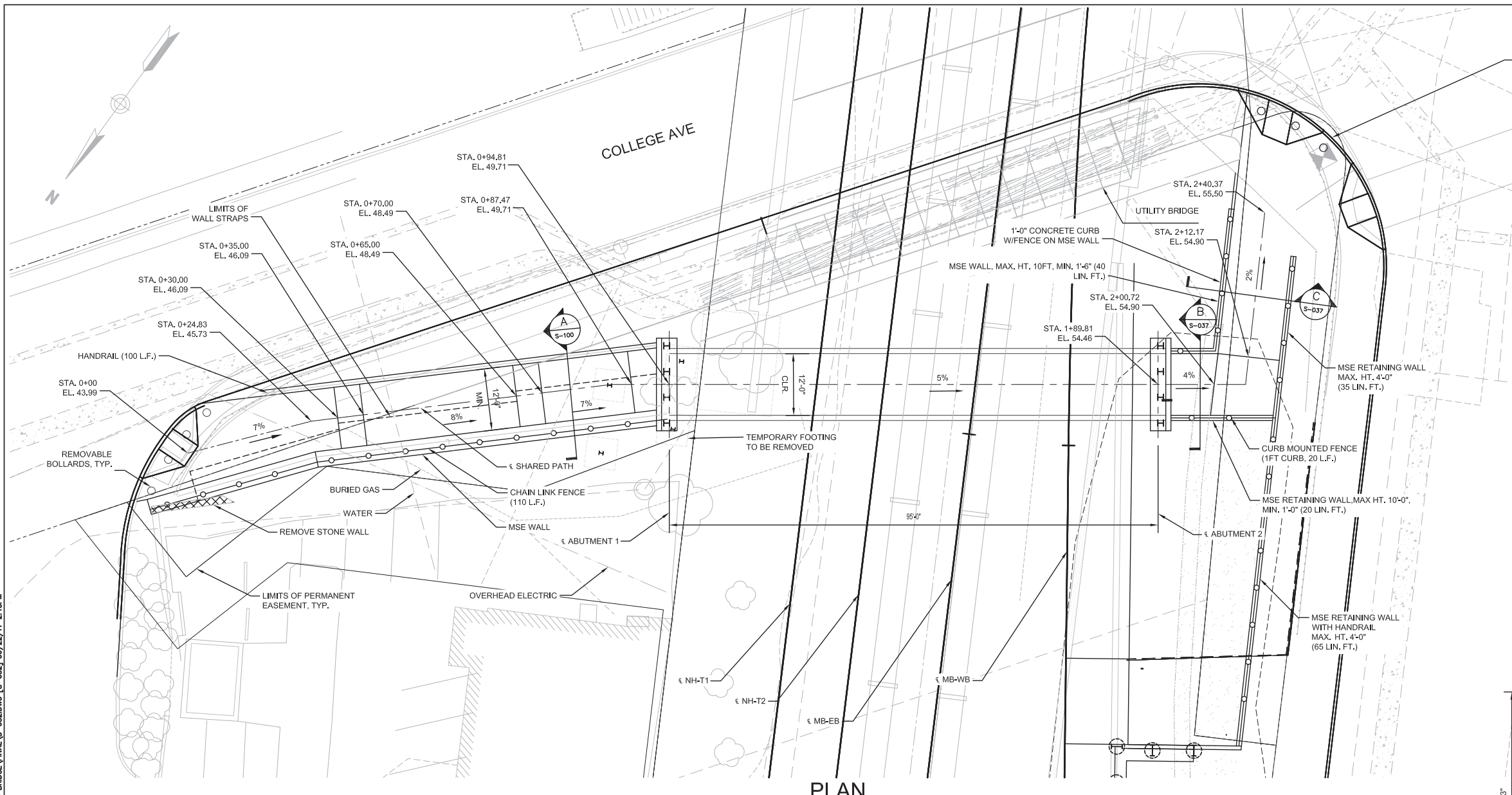

- NOTES:**
- THE EXISTING CONDITIONS SHOWN ON THIS PLAN ARE BASED UPON A COMPOSITE OF AERIAL MAPPING AND FIELD SURVEY PREPARED BY VANASSE HANGEN BRUSTLIN, INC. ON OR BEFORE MARCH, 2011, AERIAL MAPPING PREPARED BY COL-EAST, INC. ON OR BEFORE JUNE 2011 AND SURVEY PERFORMED BY BRYANT ASSOCIATES ON OR BEFORE OCTOBER 2011.
 - THE VERTICAL DATUM IS NAVD 88 NORTH AMERICAN VERTICAL DATUM OF 1988 AND DERIVED BY CONTROL ON A PLAN ENTITLED "EXISTING CONDITIONS" DATED MARCH 11, 2011 PREPARED BY VANASSE HANGEN BRUSTLIN, INC.
 - TOP OF RAIL ELEVATIONS ARE BASED ON ADVANCE CONTRACT TUFFS INTERLOCKING PROFILE WORK DATED FEB 1, 2017.
 - APPROACH RAMP, SIDEWALK AND BRIDGE TO MEET ADA REQUIREMENTS.

PROPOSAL

MASSACHUSETTS BAY TRANSPORTATION AUTHORITY
 GREEN LINE EXTENSION PROJECT
 MBTA CONTRACT NO. E22CN04
 CAMBRIDGE/SOMERVILLE, MASSACHUSETTS

COLLEGE AVENUE PEDESTRIAN BRIDGE
GENERAL PLAN AND ELEVATION

			GV20170258-272.pdf
SCALE: N.T.S.	DRAWN BY: JMP	DESIGN BY: JMP	CHECK BY: SB
DATE: SEPT. 28, 2017	PLAN NO.:	SHEET: S-032	

ISSUE	DATE	DESCRIPTION	BY	CHKD	APP.

4.3 STATIONS

Each of the seven proposed stations of the Green Line Extension DB Project will serve the community safely and efficiently. Station access and intuitive pedestrian traffic has been carefully thought out and translated into a cost effective design that will suit its riders. Well programmed stations will accommodate ridership numbers safely and consistently during all seasons of year.

Our Lead Designer, STV has served the MBTA for more than 35 years and led the design of multiple passenger stations for light rail, commuter rail, and bus rapid transit, including the Copley Station accessibility upgrade, New Balance Commuter Rail Station Public-Private Partnership, Courthouse Station, and Greenbush Line Rail Restoration Design-Build. Our team's experience and understanding of light rails stations will deliver a high-quality solution that meets the Project schedule.

4.3.A APPROACH TO MEETING THE ARCHITECTURAL REQUIREMENTS

At Gilman Square Station, we have proposed a design to raise the community path and keep it at grade level between Medford Street and School Street. This decision allowed the station entry to connect to the community path with a small elevated platform crossing over the inbound track. This connection now provides two primary access points to the station. This eliminated a 250-foot elevated walkway that had previously only connected Medford Street and a dangerous enclosed 200-foot obscured stretch of the community path that extended below Medford Street.

Each station presented its own opportunity to address individual challenges within each station design. The street level stations, East Somerville Station, Ball Square Station and Union Square Station, are exercises in accessibility and simplicity. At Lechmere Station our proposed design was driven by safety, as our team noticed challenges with obscured views and surveillance. This challenge created an opportunity to simplify the layout and increase sightlines. At-grade stations with headhouses presented challenges with vertical circulation and durable building materials. Gilman Square Station, Magoun Square Station and College Station utilize simple layouts that minimize the need to turn and present at logical progressions from approach, entry and finally boarding the train.

Durable design is imperative to the success of these stations and their ability to effectively serve the public today and in the future. Durability is addressed by selecting appropriate materials and providing a means of maintaining them. Sealed and hardened concrete will primarily compose the headhouses with galvanized and painted structural steel to maximize protection against corrosion. Similarly, all shop fabricated metals will be hot-dipped galvanized and painted. Building joints will be protected by means of flashings and mechanical fastenings. Roofing materials will be specified to have a minimum of a 25-year warranty, thermoplastic membranes being used at enclosed rooms and elevator hoistways with prefinished standing seam metal roofs at stairs, ramps, and bicycle storage areas.

“
Our design at Gilman station is a key differentiator that significantly improves safety, enhances circulation while reducing project costs.



Durable design is imperative to the success of these stations and their ability to effectively serve the public today and in the future.

Our architectural design approach to the Green Line station platforms meets the MBTA's design standards and all state and local code requirements while providing a logical, refined appearance. All required circulation clearances will be met to the satisfaction of the MBTA, Americans with Disabilities Act (ADA), and state requirements for public safety.

Approach to Accommodating Passenger Flows

Crime Prevention through Environmental Design Principles. All station elements are visible to the public from a variety of vantage points. At Lechmere Station, Gilman Square Station, Magoun Square Station and College Avenue Station, the entry sequence to the station is direct and unobscured. At each of these entrances, a rider will pass through a security grille and have the option to take stairs or an elevator to the platform. In each case, any single point is visible from multiple angles. Stairs and elevators are open to public view from at least two sides by means of transparent materials or open air enclosures. This will meet the requirements of the MBTA's Boston Center for Independent Living agreement for enhanced accessibility for people with disabilities.

Our open platform design is conducive to Crime Prevention Through Environmental Design (CPTED) principles. It increases visibility while minimizing areas of entrapment for the users, and it reduces isolation. Shelters will be surrounded by transparent acrylic-type material to maintain visibility and reduce likelihood of vandalism and lighting levels will meet the MBTA standards and provide sufficient levels of light to for public safety. We will incorporate Customer Assistance Areas, which will immediately communicate with the MBTA's security and/or police, per MBTA requirements. We will also utilize closed circuit security cameras for safety and surveillance needs.

Design Approach and Strategies to Achieving Full Accessibility. Providing full accessibility is paramount to the success of all seven stations. Codes such as 521 CMR will govern design in the case of handrails, guardrails, sloped surfaces etc. Many of the design concepts already employed at the stations such as direct line of sight, intuitive circulation and logical progression from station approach to the platform consider full accessibility. Further, a clear dimension of 6'-0" walkways, ramps, and stairs is held as a minimum clearance in all stations.

At Magoun Square Station a sloped walkway 15'-0" wide lead pedestrians to the station headhouse. This walkway is straight, does not create any pinch points and leads riders to a staircase and elevator that discharges them at the station platform level. This pedestrian progression occurs without requiring a change in direction, it simply leads riders on the most logical, direct and accessible path.

To achieve the accessibility requirements, all platform elements are centered. This will allow for a minimum of 3'-0" circulation and 6'-0" clearance for platform width, from the edge of the platform to any obstruction, such as shelters, poles, or signage.

“
While meeting regulatory requirements, we have placed platform elements in such a way to maximize passenger comfort.

Approach to Achieving an Excellent Customer Experience in the Design of Stations. Within the seven stations, there are ultimately three distinct design types:

- ▶ The three at-grade station types, (East Somerville, Ball Square and Union Square)
- ▶ The elevated approach (Magoun Square, Gilman Square Station and College Avenue)
- ▶ The elevated platform (Lechmere)

While these three station types are unique and provide the opportunity to create interesting design solutions, it is crucial to provide a recognizable connection between all seven stations tying them together as one cohesive design. Our primary design approach in cultivating excellent customer experiences is simplicity. Simplicity in our design proposal is translated through a recognizable design feature and intuitive circulation by minimizing directional change. These design features create a logical, comfortable, and accessible progression from approach to the station, accessing the platforms, and utilizing the trains.

The platform design considers the importance of the user experience, including:

- ▶ Incorporating video message boards that keep riders informed about train arrival and departure times
- ▶ Providing strategically placed benches and shelters to keep riders safe from the natural elements
- ▶ Integrating a barrier-free design for wheelchair accessibility on the platform and into the shelters
- ▶ Including a minimum of three benches will be available at each platform to provide a resting area for riders

In addition, Customer Assistance Areas are available for informational purposes or for safety and security measures as necessary. Wayfinding signage and maps will be clearly visible and regularly interspersed along the platform coordinated with the MBTA wayfinding design standards, and we will have sufficient lighting to provide an added layer of safety in the evenings.

Approach to Ensuring Each Station is Clearly Identified

Each station is identified with proper signage to direct pedestrians to the station entrance. Station architecture and signage will be legible and recognizable for pedestrians and motorists.

As riders approach the platform, the MBTA's standard signage will be first, foremost, and obvious. Signage frames with the station name, maps for inbound and outbound lines, and an overall MBTA system line map will be clearly visible.

Approach to Interfaces with Existing Right-of-Way

Each station will be located either within the existing right of way or the acquired right of way. Each station will provide ADA-compliant access to existing sidewalk or the proposed community path.

Interfaces with Adjacent Vehicular Traffic. Stations will interact with traffic on the adjacent roadways in three ways:

1. Increased pedestrian traffic to and from the station will conflict with vehicular traffic at the surrounding intersections. GLX Constructors will make physical improvements to affected intersections and optimize traffic signals to minimize delay and maximize safety and accessibility for all users. Improvements such as constructing an over-the-track pedestrian bridge to access the station as shown on College Avenue Station, and utilizing the Community Path to enter the station on Gilman Square Station and East Somerville.
2. Pedestrians have a tendency to use the curbside as a drop off and pick up space. Station designs will account for this behavior by either creating formal drop-off areas to help organize passengers' movements, or by including features to discourage stopping on the street where it would be dangerous or disrupt the flow of traffic.
3. Station features will be easily visible. The architecture and signage will be recognizable, attractive, and legible for both pedestrians and motorists.

Interfaces with Bicycle Paths. A bicycle-friendly design will extend from Green Line stations to virtually all of Somerville and Medford. Our team is familiar with this area and with cyclists' needs. For example, the touchdown points, where station walkways meet the street, will account for different directions and passengers arriving to station entrances. These entrances will be located as close as possible to crosswalks, so they can be reached safely from either side of the street. Bicycle infrastructure at the station, such as bike cages and racks, will be located as close as possible to where cyclists would naturally dismount. By doing so, bicyclists will not have to push their bikes through crowds, and they are not tempted to ride on sidewalks, which is a safety concern.

Description of the Shelter Design

The shelter design will conform to the platform's light pole spacing and available width. Once light pole spacing and final platform width is determined, accommodating the seating lengths and space for wheelchair access between light poles will determine width. The depth of shelters will be determined by the width of the narrowest platform with clear access route dimensions, as provided by station platform standards. As that is determined, the dimensions will be applied to the remainder of the station platforms. The minimum number of shelters for the open platforms is indicated in the technical provisions.

Approach to Materials and Finishes. Shelters will be designed using many types of metals, such as stainless steel, galvanized steel, painted steel, anodized or painted aluminum, or other materials, such as woods and structural plastics. In our experience, metals are the most effective material that requires the least amount of maintenance.

Approach to Envelopes. Our approach to designing the shelter envelopes is CPTED-compliant with transparent appearances that eliminate any hidden areas within or around the shelter.

We will use clear acrylic, or other clear forms of plastic or safety glazing, for the shelter envelope to deliver transparency. The glazing panels at the shelter perimeter and roof will be vandalism proof. From a safety perspective, this will allow the light from the light poles to penetrate through the roof and adequate lighting in the shelters.

Approach to Weather Protection. With the open platform approach, it is imperative to provide a sufficient number of platform shelters for riders during inclement weather. Platform shelter quantity shall be determined by the technical provisions within the RFP. The shelter construction will contain strengthened glazing panels (acrylic and/or polycarbonate) with a framing system to protect from year-round weather patterns. The roofing panels will slope outward so that water drips away from openings. Glazing panels will be anchored to structure, gasketed, and sealed to prevent water from dripping and vapor from migrating into the shelter.

Methodology Used to Determine the Number and the Size of Shelters at Each Station. In determining the number and size of the shelters at each station, we studied the MBTA's trends for selecting shelter types, design, and construction. We reviewed half a dozen shelters that are customizable and have a progressive design. These shelters also have interchangeable components that accommodate the shelter's layout, which we determine by the requirements established in the Technical Provisions.

Approach to Organization of Required Platform Equipment, Elements, and Amenities. Largely, the organization of platform elements, equipment, and amenities will be dictated by the MBTA's standards indicated in the Technical Provisions.

Signage with maps will be located closest to platform entrances, while signage with advertisements will be located furthest from the entrances. Signage that offers customer assistance will be sheltered, and it will be located in front of the second door of the lead train facing both the inbound and outbound tracks. Message boards and fare vending machine locations are similarly indicated in the Technical Provisions, and they require careful coordination with other platform elements.

Shelters and benches will be equally spaced between signage requirements and light poles. Light poles are spaced to maximize the lighting level requirement at the heights indicated in the Technical Provisions. All additional elements and amenities, such as the official's booth, trash receptacles, and sand and salt sheds, will be efficiently interspersed throughout the platform.

4.3.B ARCHITECTURAL DRAWINGS OF EACH STATION

Architectural drawings of each station are included at the end of this section.

Context Plans, Signage, Lighting, Catenary, and Fare Collection Equipment

Lechmere Station. As the only station that is part of the Green Line Extension DB Project with an elevated platform, it was important to thoughtfully identify the challenges and opportunities associated with design a station of this type. Visibility and intuitive connection becomes more of a challenge. Therefore, direct access and two primary points of entry help to increase the station's ability to be recognizable. Sightline views from five streets reveal transparent stair enclosures, glass elevators and station signage that will clearly indicate that riders are to progress to an upper level where train are boarded. After riders make their way to the lower level of the head house and proceed to the upper level, they simply arrive at the platform at the top of either a stair or elevator.

Union Square Station. The lollipop signs located on Prospect Street and a clear street connection intuitively guide riders to the entry of Union Square Station. From this vantage point, the roll up security grill supporting the Union Station sign is clearly visible between the track ends. At the east end of the platform a second means of egress is at the south end of the platform and exits the ROW.

East Somerville Station. East Somerville Station is accessed either from Washington Street via the lower community path, or the upper community path. For those entering from Washington Street, the station is marked by a lollipop sign at the sidewalk. A second lollipop sign will be placed at the upper community path landing parallel to the platform. A second means of egress is provided at the north end of the platform on to the upper community path.

Gilman Square Station. Accessed via the Community Path at grade level between Medford Street and School Street, a short platform over the inbound tracks serves as the station's entry. Space accommodations for the catenary equipment have been made under this platform. This simple connection engages the community path and provides two primary access points to the station via Medford Street and School Street. Bike storage is available along the community path directly across from the roll-up security grill at the station entry. Entry through security grill leads to the station headhouse with a stair and elevator discharging on the platform. A second means of egress is located at the west end of the platform with an at-grade walkway leading to a covered switchback ramp terminating at the School Street Bridge.

Magoun Square Station. Access to the station from the Lowell Street Bridge is indicated by a lollipop sign at the beginning of a slightly sloped walkway to the station headhouse. Access directly off of Lowell Street begins at an elevated platform spanning over the inbound track where bike storage and fare vending machines are available. The sloped walkway provides direct sightlines to headhouse where stairs and an elevator discharge riders directly on to the platform. This station is highlighted by a single direct means access with no direction changes and an intuitive approach and exit from the platform.

Ball Square Station. Visibility of the Ball Square Station is highlighted in the design in order to approach the challenge of a single access point. This access point is located close the intersection of Boston Avenue and Broadway Street in order to increase exposure to pedestrians. Bike storage and MBTA signage occupies the station's frontage along Boston Ave. Along the bike cage, sloped walkways guide riders to the station's entry where a roll up security grill secures the station. Emergency egress is provided at the north side of the platform with a sloped walkway guiding riders to a point of safety.

College Avenue Station. College Station is just outbound of the College Avenue Bridge. Riders enter the station headhouse from a sidewalk along Boston Avenue. The access to the headhouse bridges the rail line. Space accommodations for the catenary equipment have been provided under this structure. The MBTA station signage will be visible from a new pedestrian bridge paralleling the existing College Avenue Bridge, as well as, along Boston Avenue. A direct line of sight to a stairway leading to the platform is visible upon entry to the station house via a roll up security grill along the Boston Ave station entry. Riders may follow a walkway adjacent to the stairway to access two elevators with covered queuing space. Upon discharge from the stairway and elevators, a short pathway at the lower level of the headhouse allows access on the platform. Similar to Magoun Station an accessible safety dispersal area will be provided at the north end of the platform.

Fare Collection Equipment. The fare collection equipment will be provisioned by providing fiber optic cabling and network connectivity infrastructure at each station. Fare vending machines are provided under the MBTA's AFC2.0. Fare entrance gate arrays are expected to be no longer part of the fare collection program at the time of completion for the Project.

The Supervisory Control and Data Acquisition (SCADA) with Hub Monitoring and Control System (HMCS) will be automatically and manually monitor an array of systems and subsystems within the MBTA's infrastructure, including ancillary facilities.

Lighting. LED full, cut off pole-mounted lighting fixtures are provided on platforms where the highest lighting levels are desired, which is 35 foot candle on average, and 55 foot candle along the platform edge. Poles are spaced at 15 feet on center with the appropriate number of fixtures to achieve these foot

candle levels and as not to encroach on the travel path along the platform and passenger waiting areas, as dictated by MBTA standards.

Lighting on entrance and exit paths to the platform will also be provided by pole-mounted lighting fixtures, except where overhangs or structures are present. In these spaces, a combination of both pendant and surface mount lighting fixtures have been selected and will be designed to provide appropriate lighting levels in accordance with MBTA standards and life safety requirements.

All fixtures selected will be rough service type, appropriate for outdoor conditions, and will be mounted at a height such that access for maintenance and cleaning can be achieved via step ladders.

All lighting will be controlled centrally through a photocell and timeclock combination, which will allow the MBTA to control on/off for outside of revenue hours.

HVAC and Plumbing. Lechmere and College Station have occupied rooms that require heating, ventilating, and air conditioning for the comfort of the MBTA's staff. Systems will be designed to meet state code requirements, specifically the International Energy Conservation Code and the International Mechanical Code.

Unoccupied spaces, including emergency electrical, communications, and EMF rooms are provided with electric unit heaters and ductless split air conditioners to control the space conditions. Main electrical rooms are provided with electric heat for the winter and exhaust fans for summer ventilation. Elevator control rooms are provided with electric heat, ductless split cooling and ventilated per the requirements of 524 CMR, the Board of Elevator Regulations. Elevator hoist ways have vents as required under 524 CMR. The condensers for cooling at Gilman, Ball, Magoun, East Somerville, and Union Stations are located outside the communication rooms at grade, typically between the two tracks at the end of the stations. The condensers for Lechmere and College are located on roofs or at grade away from passenger traffic.

At Lechmere Station, the Police Reporting Station and Bus Operation booth are served by a variable refrigerant flow heat pump for heating and cooling, with ventilation air through an energy recovery ventilator for energy savings. The toilet room and janitors closet are heated by baseboard heaters and exhausted with the energy recovery ventilator. At College Station, the Operators Lounge is heated and cooled by a variable refrigerant flow heat pump, and an energy recovery ventilator provides fresh air to the Operator's Lounge and exhaust for the toilet and janitor's closet. Baseboard heat is provided to the toilet and janitor's closet.

The station plumbing design for all stations will follow all state codes and will comply with ADA codes. Plumbing systems at College Station and Lechmere include toilet and lavatories in the men's and women's rooms, and service sinks in the janitors closets. Kitchen-type sinks are also provided in the Lechmere

kitchenette and the College Station Operator's Lounge. Hot water is provided by instantaneous, tankless water heaters. Locking exterior frost-proof hose bibbs are provided at both stations for wash down purposes. All plumbing fixtures will be served by an incoming domestic water service and sanitary system. Storm drainage and downspouts will be routed from roof areas of the vertical circulation elements (elevator and stair headhouses) at College, Gilman, and Magoun Stations down to a closed drainage system at all stations, which is typically located within the track bed below the subgrade, with the exception of Lechmere which the closed system will be below street level.

Additional Details or Key Dimensions to Demonstrate Technical Provisions are Met or Exceeded

- ▶ Stairs and ramps will be covered with standing seams roofs that extend 5'-0" beyond the top and bottom landing or stair run. Similarly, elevator entry/exits are covered by a 5'-0" deep overhang.
- ▶ Walkways with slopes below 4.5 percent transition from walkways or headhouses down to the platform as shown in the included drawings. Stations are designed to accept a 6" topping slab in the future, bringing the top of platform at to a height of 14" above top of rail.
- ▶ Platform light poles attach to the top of 6" concrete pedestal. Light poles can be removed and re-fastened after the 6" topping slab is complete. This will not impact the existing slab or light pole foundation. Shelter's benches and other platforms elements will be attached to the new slab with concrete anchors or epoxy anchors.
- ▶ All platforms, with the exception of Lechmere, are 225' feet long with varying widths, however not any smaller the 20'-0" in width. A 75'-0" space for extension has been allowed for future extension.
- ▶ All stairs are designed to have 7" maximum riser heights and 12" tread lengths.
- ▶ All handrails are 1½" outside diameter heavy wall 316L stainless steel and will be continuous.
- ▶ Elevator queuing space extended at minimum of 9'-0" deep from elevator doors and does not extend into a main path of travel.
- ▶ Areas of rescue assistance, 5'-0" x 9'-0" deep, are located adjacent to elevator doors and do not encroach on the main path of travel.

GLX Constructors' has carefully reviewed the Volume 2 Technical Provisions section 12.1 through 12.5 and the related project definition plans as they relate to the design and operation of the seven Green Line Extension Project stations. Based on our collective experience and understanding of the Project requirements, we have developed a design approach for each of the seven stations which emphasizes:

- ▶ Intuitive direct circulation
- ▶ Durable building materials
- ▶ Rider safety
- ▶ Ease of maintenance
- ▶ Logical design principles

ITP Request	RFP		
	Drawing Number	Drawing Title	Reference Section or Drawing
Lechmere			
A5.2.3.B.1			4.3(STA-001); 4.6(C-004)
A5.2.3.B.2	STA-001	Lechmere Station – Site Plan – Street Level	
A5.2.3.B.2	STA-002	Lechmere Station – Lobby Level Plan	
A5.2.3.B.2	STA-003	Lechmere Station – Platform Level Plan	
A5.2.3.B.2	STA-004	Lechmere Station – Platform and Furnishings	
A5.2.3.B.2	STA-005	Lechmere Station – Platform and Furnishings	
A5.2.3.B.3	STA-006	Lechmere Station – Elevations	
East Somerville			
A5.2.3.B.1			4.3(STA-007); 4.6(C-009)
A5.2.3.B.2	STA-007	East Somerville Station – Site Plan	
A5.2.3.B.3	STA-008	East Somerville Station – Platform and Furnishings	
Gilman Square Station			
A5.2.3.B.1			4.3(STA-009); 4.6(C-014)
A5.2.3.B.2	STA-009	Gilman Square Station – Site Plan	
A5.2.3.B.2	STA-010	Gilman Square Station – Overall Plan	
A5.2.3.B.2	STA-011	Gilman Square Station – Emergency Egress Ramp Elevations	
A5.2.3.B.2	STA-012	Gilman Square Station – Building Sections	
A5.2.3.B.3	STA-013	Gilman Square Station – Platform and Furnishings	
Magoun Square			
A5.2.3.B.1			4.3(STA-014); 4.6(C-017)
A5.2.3.B.2	STA-014	Magoun Square Station – Site Plan	
A5.2.3.B.2	STA-015	Magoun Square Station – Overall Plans	
A5.2.3.B.2	STA-016	Magoun Square Station – Building Sections	
A5.2.3.B.3	STA-017	Magoun square Station – Platform and Furnishings	

ITP Request	RFP		
	Drawing Number	Drawing Title	Reference Section or Drawing
Ball Square			
A5.2.3.B.1			4.3(STA-018); 4.6(C-020)
A5.2.3.B.2	STA-018	Ball Square Station – Site Plan	
A5.2.3.B.3	STA-019	Ball Square Station – Platform and Furnishings	
College Avenue			
A5.2.3.B.1			4.3(STA-020); 4.6(C-023)
A5.2.3.B.2	STA-020	College Avenue Station – Site Plan	
A5.2.3.B.2	STA-021	College Avenue Station – Station Platform Floor Plan	
A5.2.3.B.2	STA-022	College Avenue Station – Boston Ave Floor Plan	
A5.2.3.B.2	STA-023	College Avenue Station – Building Sections	
A5.2.3.B.3	STA-024	College Avenue Station – Platform and Furnishings	
Union Station			
A5.2.3.B.1			4.3(STA-025); 4.6(C-031)
A5.2.3.B.2	STA-025	Union Station – Site Plan	
A5.2.3.B.3	STA-026	Union Station – Station Platform and Furnishings	

Technical Solutions Drawing Matrix.

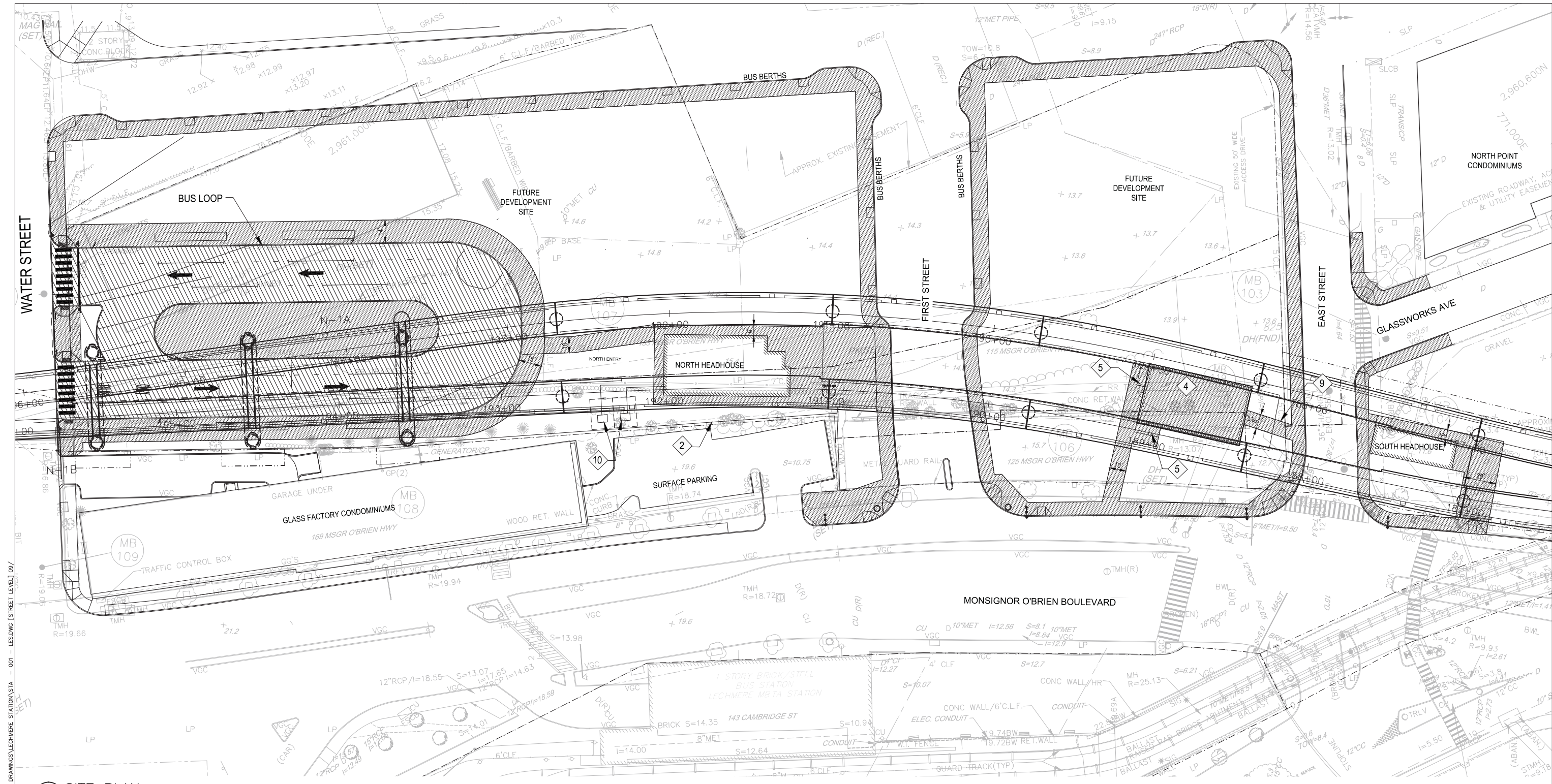

1 SITE PLAN
SCALE: 1"=30'

- KEYNOTES**
- 2 CHAINLINK FENCE
 - 4 BICYCLE STORAGE
 - 5 BICYCLE RACK
 - 9 ACCESSIBLE PATH
 - 10 TRANSFORMER

- LEGEND**
- PROPOSED CONCRETE
 - PROPOSED ASPHALT

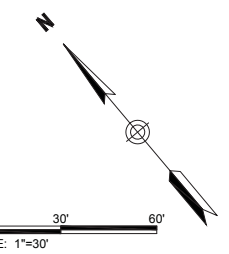

PROPOSAL

MASSACHUSETTS BAY TRANSPORTATION AUTHORITY
GREEN LINE EXTENSION PROJECT
MBTA CONTRACT NO. E22CN04
CAMBRIDGE/SOMERVILLE, MASSACHUSETTS

**LECHMERE STATION
SITE PLAN - STREET LEVEL**



SCALE: AS NOTED		DATE: SEPT 28, 2017	DRAWN BY: YQT	DESIGN BY: YQT	CHECK BY: MWR	PLAN NO.	ISSUE
ISSUE	DATE	DESCRIPTION	BY	CHKD	APP.	SHEET: STA-001	

PLOTTED: 09/14/17 11:56AM BY: TANUSV
 DRAWING: I:\PROPOSALS\2017\062820 0002 GLX GREEN LINE STATIONS\CIVIL SITE DRAWINGS\LECHMERE STATION\STA - 001 - LES.DWG (STREET LEVEL).DWG

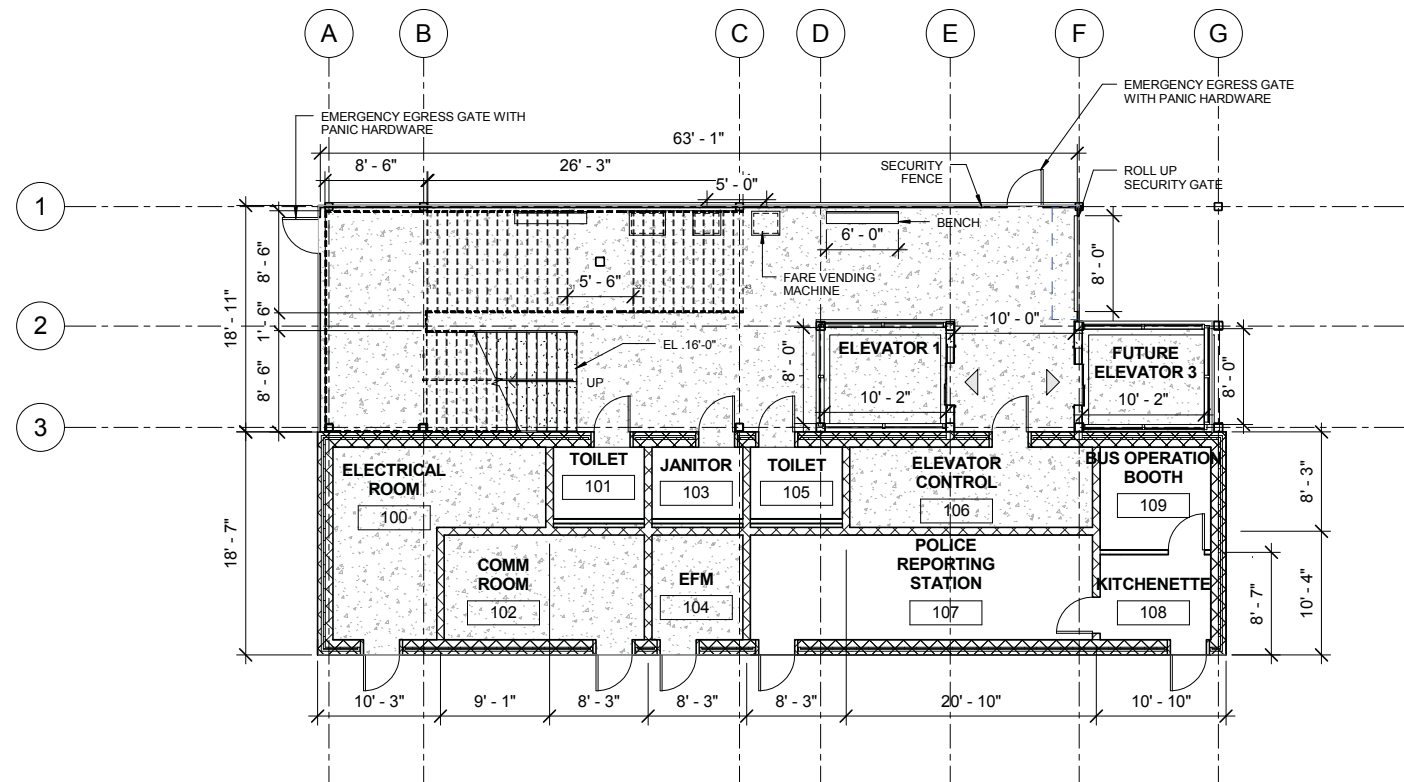

2 LOBBY LEVEL- STATION NORTH ENLARGED

2
002
1/8" = 1'-0"

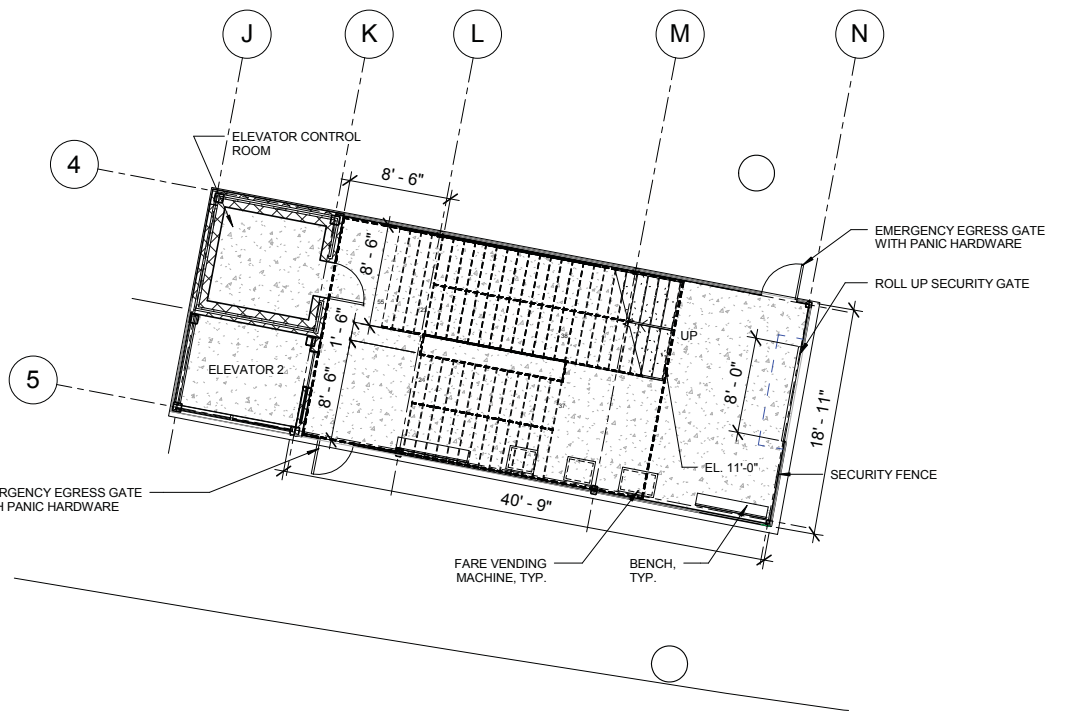

3 LOBBY LEVEL- STATION SOUTH ENLARGED

3
002
1/8" = 1'-0"

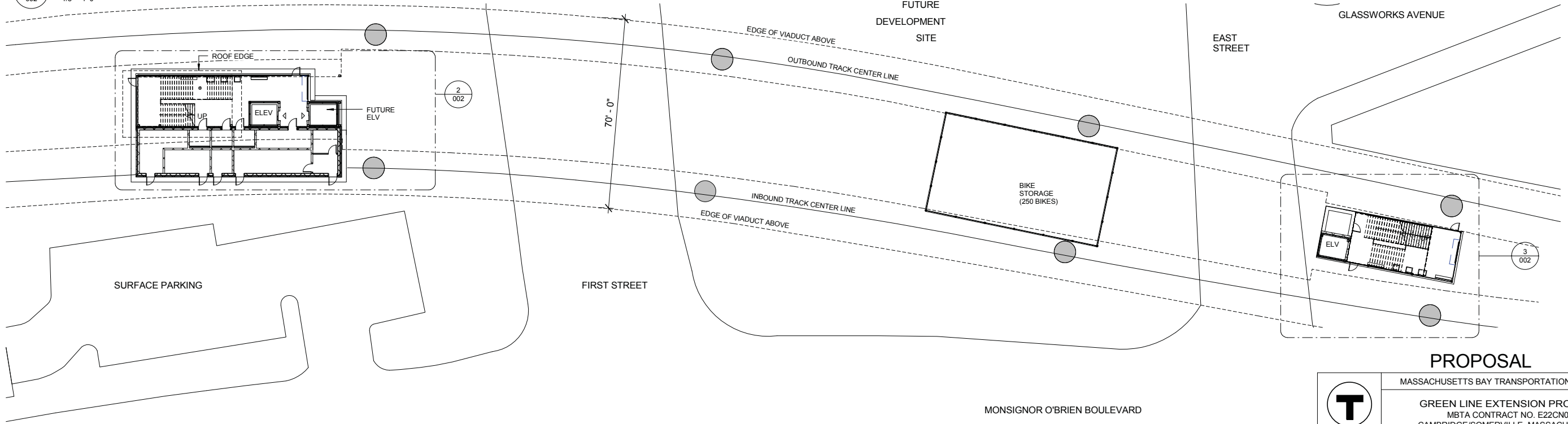
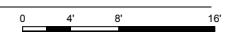

1 LOBBY LEVEL NORTH

1
006
1" = 20'-0"



PROPOSAL

MASSACHUSETTS BAY TRANSPORTATION AUTHORITY

T

GREEN LINE EXTENSION PROJECT
 MBTA CONTRACT NO. E22CN04
 CAMBRIDGE/SOMERVILLE, MASSACHUSETTS

**LECHMERE STATION
 LOBBY LEVEL PLAN**

STV 100 Years

massDOT
 Massachusetts Department of Transportation

GLX
 CONSTRUCTORS

SCALE: As indicated
 DATE: SEPT. 28, 2017
 DRAWN BY: MS
 DESIGN BY: SM
 CHECK BY: SM
 PLAN NO.:
 SHEET: STA-002

ISSUE

GV20170258-273.pdf

9/14/2017 1:45:16 PM C:\Users\shebua\Documents\Lechmere_A3D0000_Shebua.rvt

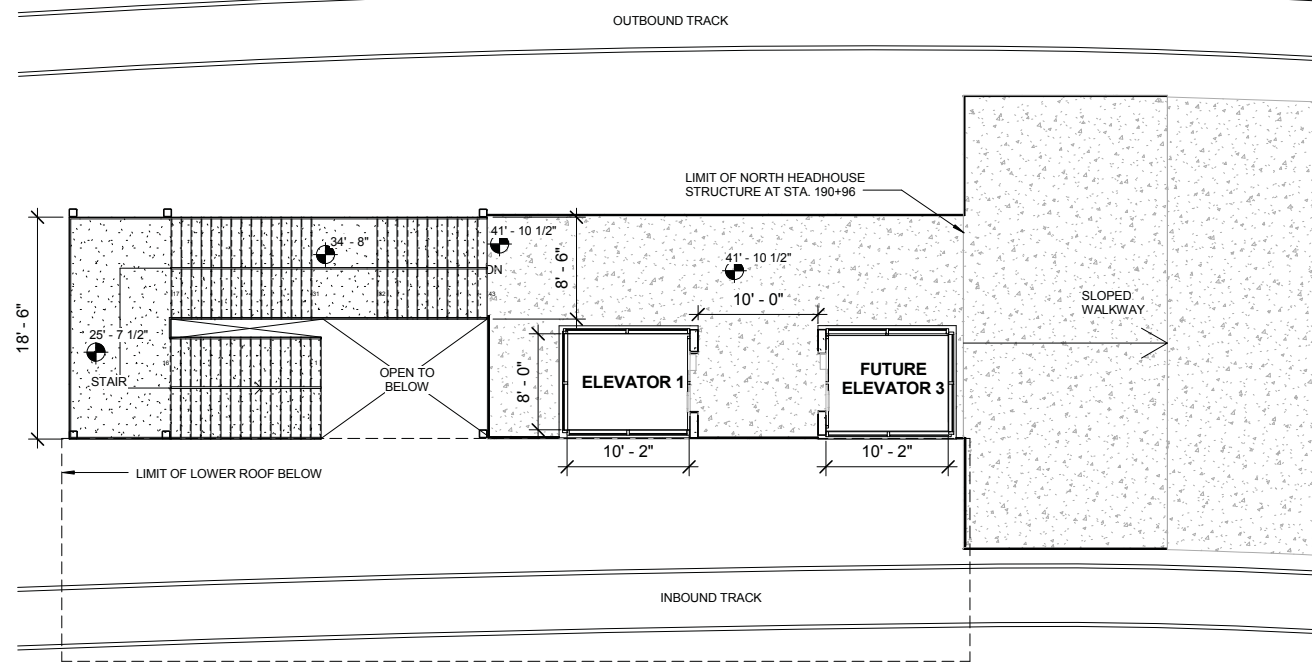

2
003 1/8" = 1'-0"
PLATFORM LEVEL - STATION NORTH ENLARGED

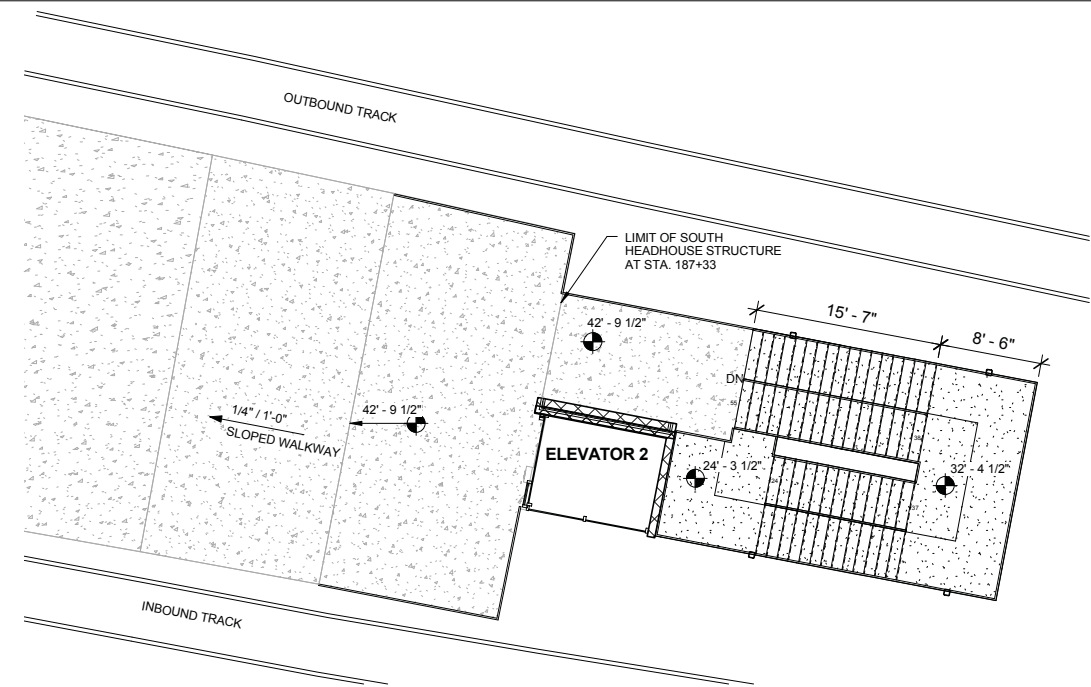

3
003 1/8" = 1'-0"
PLATFORM LEVEL - STATION SOUTH ENLARGED

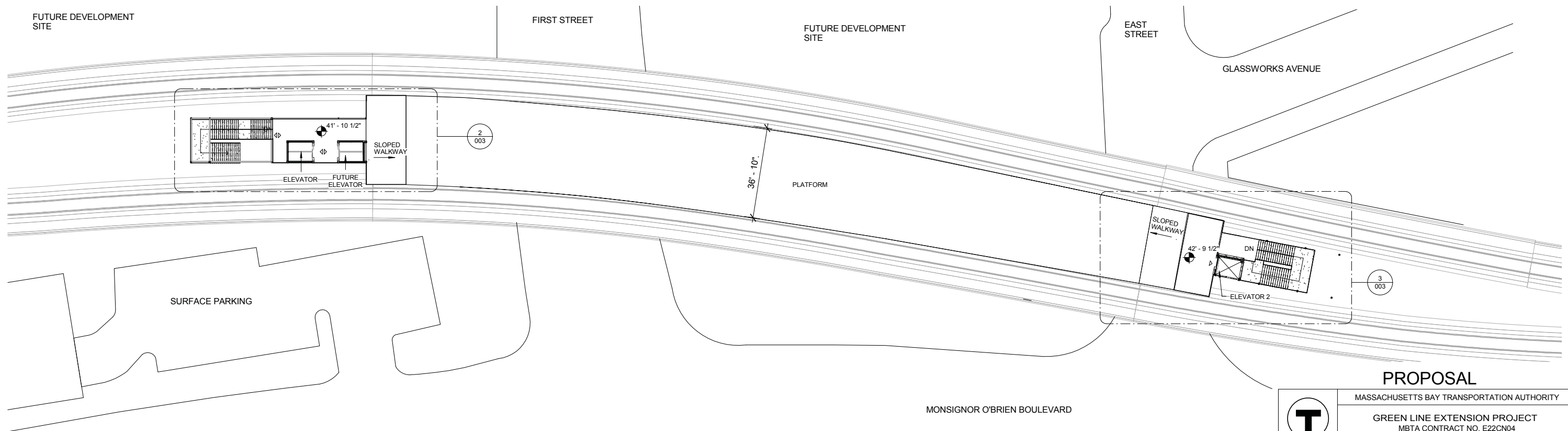

1
006 3/64" = 1'-0"
PLATFORM LEVEL STATION PLAN

PROPOSAL

MASSACHUSETTS BAY TRANSPORTATION AUTHORITY
GREEN LINE EXTENSION PROJECT
MBTA CONTRACT NO. E22CN04
CAMBRIDGE/SOMERVILLE, MASSACHUSETTS

**LECHMERE STATION
PLATFORM LEVEL PLAN**



GV20170258-273.pdf

ISSUE	DATE	DESCRIPTION	BY	CHKD	APP.	SCALE: As indicated	DRAWN BY: MS	DESIGN BY: SM	CHECK BY:	PLAN NO.	ISSUE
						DATE: SEPT. 28, 2017				SHEET: STA-003	

KEYNOTES

- 10 - PLATFORM
- 11 - CUSTOMER ASSISTANCE AREA & BENCH
- 12 - SHELTER
- 14 - TACTILE EDGE
- 15 - OFFICIALS BOOTH
- 16 - EMERGENCY EGRESS @ RAISED PLATFORMS
- 17 - EMERGENCY GATE @ RAISED PLATFORMS

- 20 - SIGNAGE MAP ASSEMBLY
- 36 - LIGHT POLE
- 40 - WASTE RECEPTACLES
- 41 - SALT STORAGE BIN
- 42 - SAND STORAGE BIN
- 43 - STARTER'S BOOTH @ (UNION & COLLEGE STATION)
- 44 - VARIABLE MESSAGE SIGNS (VMS)

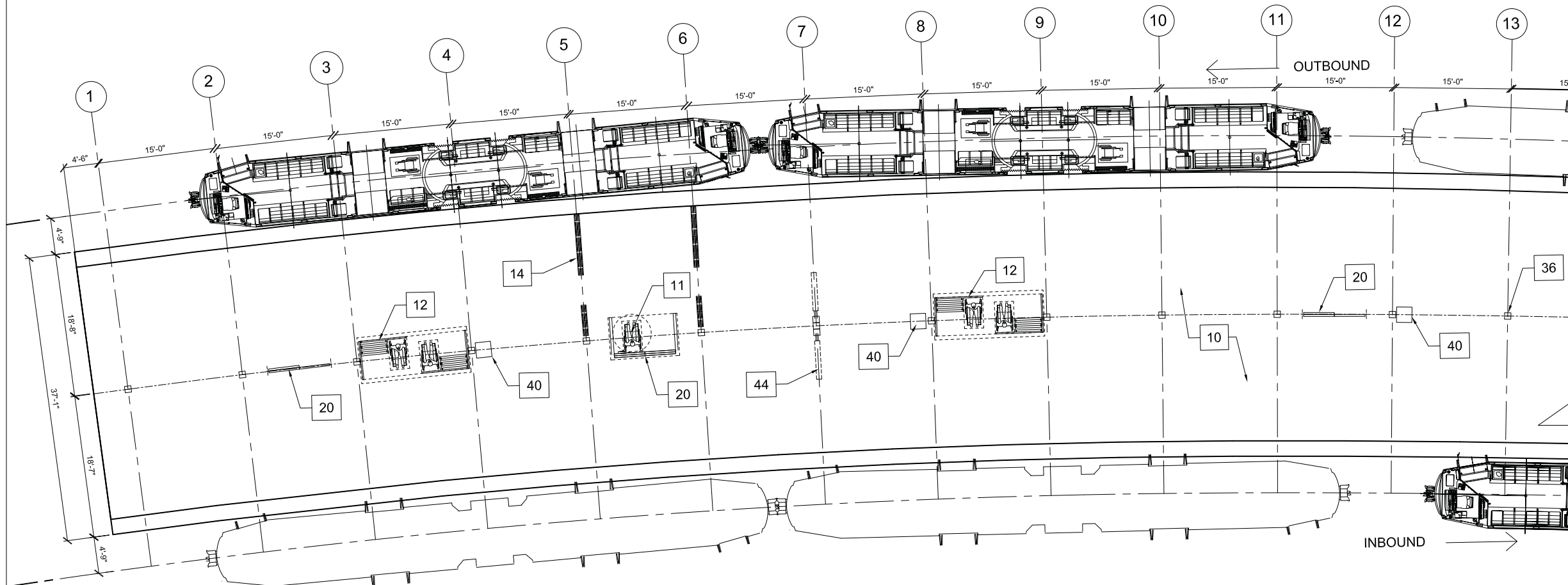
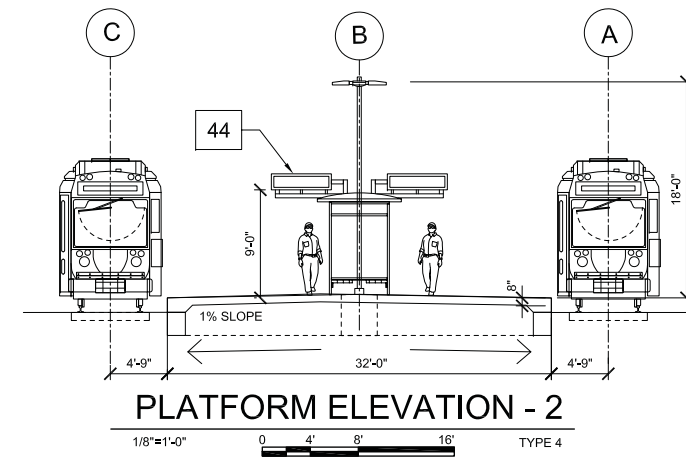

PLATFORM FLOOR PLAN - PART 1

1/8"=1'-0" 0 4' 8' 16' TYPE 4 DATE: 7-14-17

TYPE 4-WIDTH VARIES (32'-0" to 37'-0")
LECHMERE STATION

TOTAL LENGTH @ CENTER LINE OF
PLATFORM=339'-4"

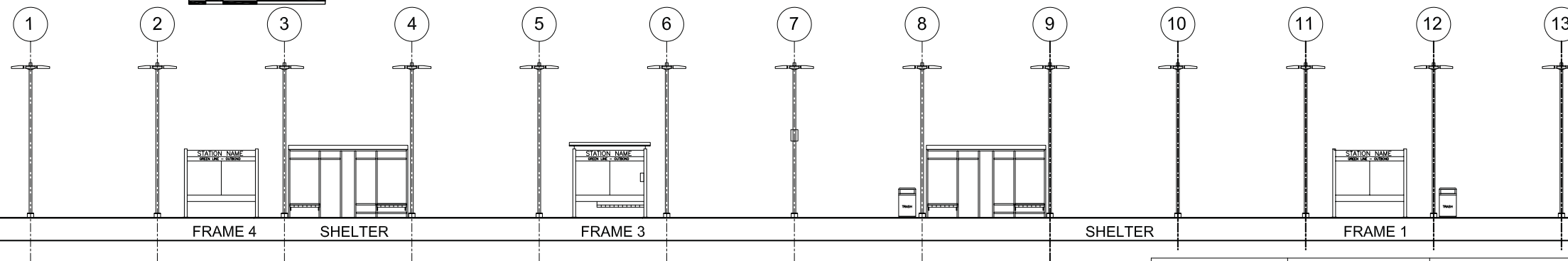

PLATFORM TYPE 4 - LECHMERE- 32'-0" to 37'-0" WIDE PLATFORM

PROPOSAL

MASSACHUSETTS BAY TRANSPORTATION AUTHORITY



GREEN LINE EXTENSION PROJECT
MBTA CONTRACT NO. E22CN04
CAMBRIDGE/SOMERVILLE, MASSACHUSETTS

**LECHMERE STATION
PART 1, STATION PLATFORM
ELEVATION AND SECTION**



GV20170258-273.pdf

SCALE: AS NOTED	DRAWN BY	DESIGN BY	CHECK BY	PLAN NO.	ISSUE
DATE: SEPT. 28, 2017	PDS	PDS	EMT	SHEET: STA-004	
ISSUE	DATE	DESCRIPTION	BY	CHKD	APP.

KEYNOTES

- 10 - PLATFORM
- 11 - CUSTOMER ASSISTANCE AREA & BENCH
- 12 - SHELTER
- 14 - TACTILE EDGE
- 15 - OFFICIALS BOOTH
- 16 - EMERGENCY EGRESS @ RAISED PLATFORMS
- 17 - EMERGENCY GATE @ RAISED PLATFORMS

- 20 - SIGNAGE MAP ASSEMBLY
- 36 - LIGHT POLE
- 40 - WASTE RECEPTACLES
- 41 - SALT STORAGE BIN
- 42 - SAND STORAGE BIN
- 43 - STARTER'S BOOTH @ (UNION & COLLEGE STATION)
- 44 - VARIABLE MESSAGE SIGNS (VMS)

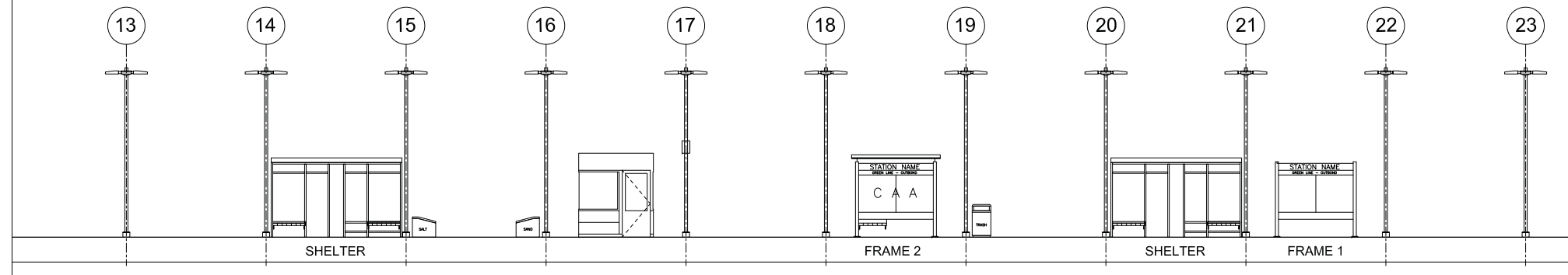
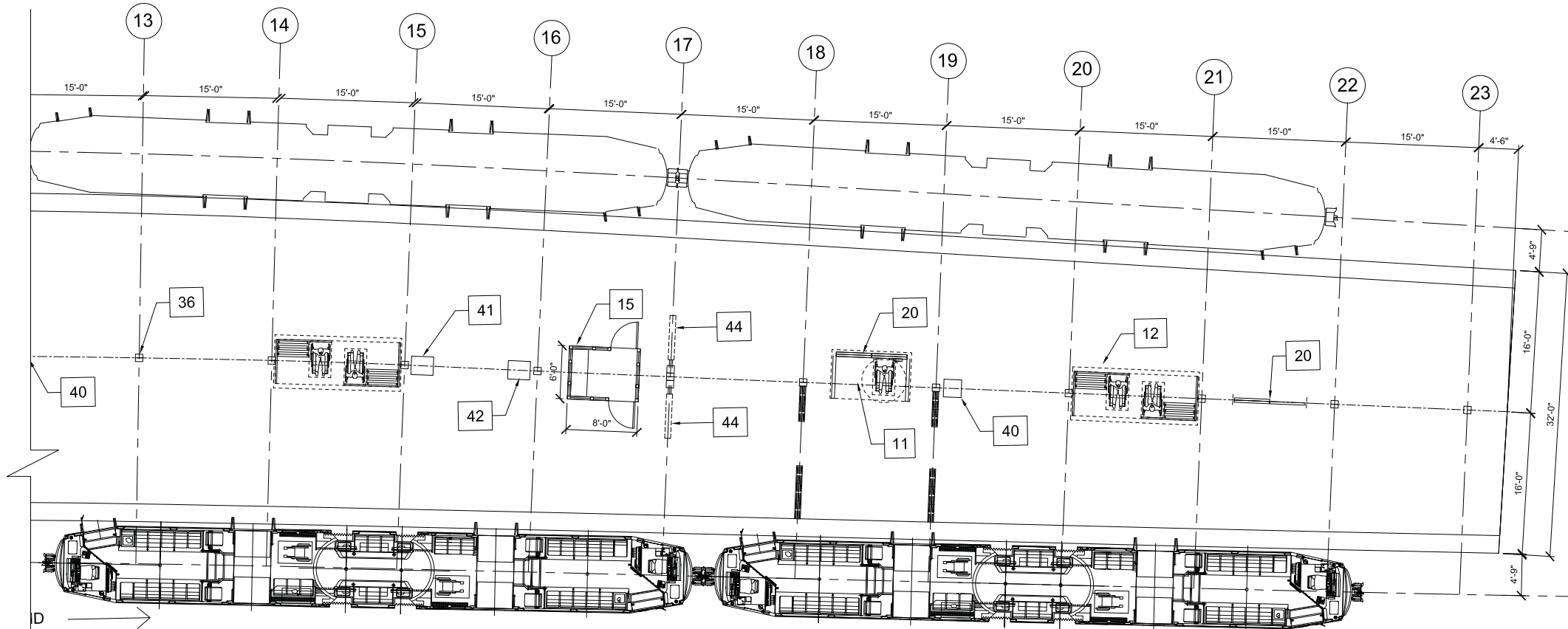
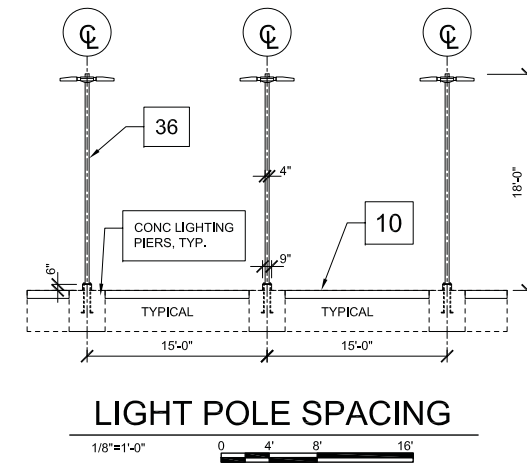

PLATFORM TYPE 4 - LECHMERE- 32'-0" to 37'-0" WIDE PLATFORM

PROPOSAL

T MASSACHUSETTS BAY TRANSPORTATION AUTHORITY
 GREEN LINE EXTENSION PROJECT
 MBTA CONTRACT NO. E22CN04
 CAMBRIDGE/SOMERVILLE, MASSACHUSETTS

**LECHMERE STATION
 PART 2, STATION PLATFORM
 ELEVATION AND SECTION**

SCALE: AS NOTED	DRAWN BY: PDS	DESIGN BY: PDS	CHECK BY: EMT	PLAN NO. .	ISSUE
DATE: SEPT. 28, 2017				SHEET: STA-005	GV20170258-273.pdf

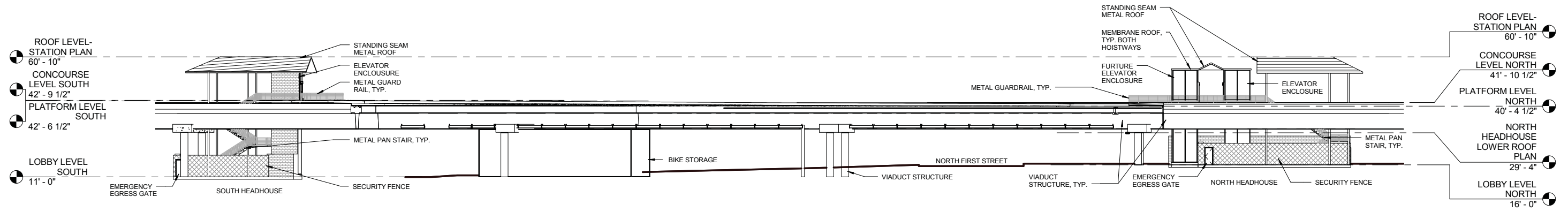

1
3/64" = 1'-0"

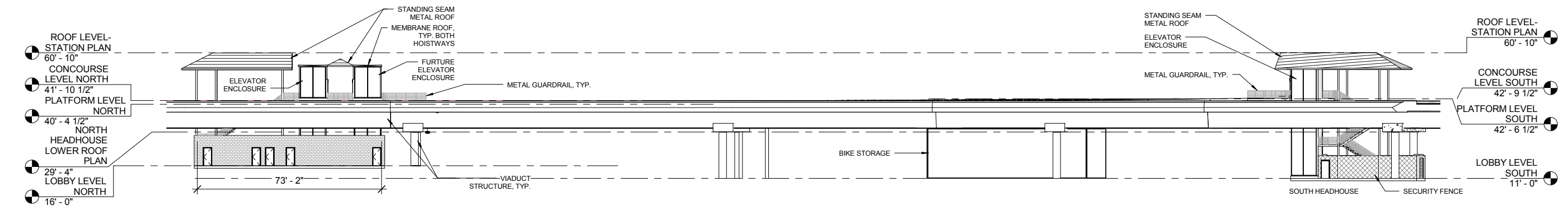

2
3/64" = 1'-0"

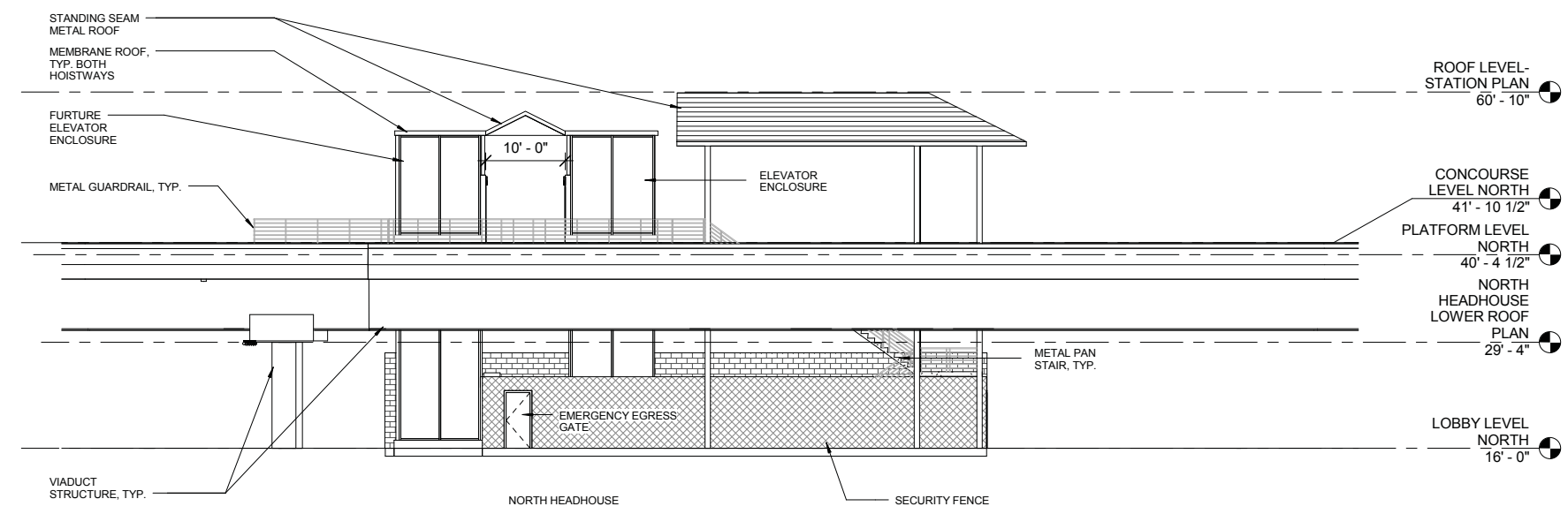

3
3/32" = 1'-0"

PROPOSAL
 MASSACHUSETTS BAY TRANSPORTATION AUTHORITY
 GREEN LINE EXTENSION PROJECT
 MBTA CONTRACT NO. E22CN04
 CAMBRIDGE/SOMERVILLE, MASSACHUSETTS

LECHMERE STATION ELEVATIONS

SCALE: As indicated		DRAWN BY: AH	DESIGN BY: SM	CHECK BY:	PLAN NO.
DATE: SEPT. 28, 2017		SHEET: STA-006		ISSUE	
ISSUE	DATE	DESCRIPTION	BY	CHKD	APP.

9/14/2017 2:05:30 PM
 C:\Users\shebua\Documents\Lechmere_A3D0000_Shebua.rvt

PLOTTED: 09/14/17 11:45AM BY: TANSUO
 DRAWING: I:\PROJECTS\2017\062820 0002 GLX GREEN LINE STATIONS\EAST SOMERVILLE\STA - 007 - ESS.DWG [SITE PLAN]

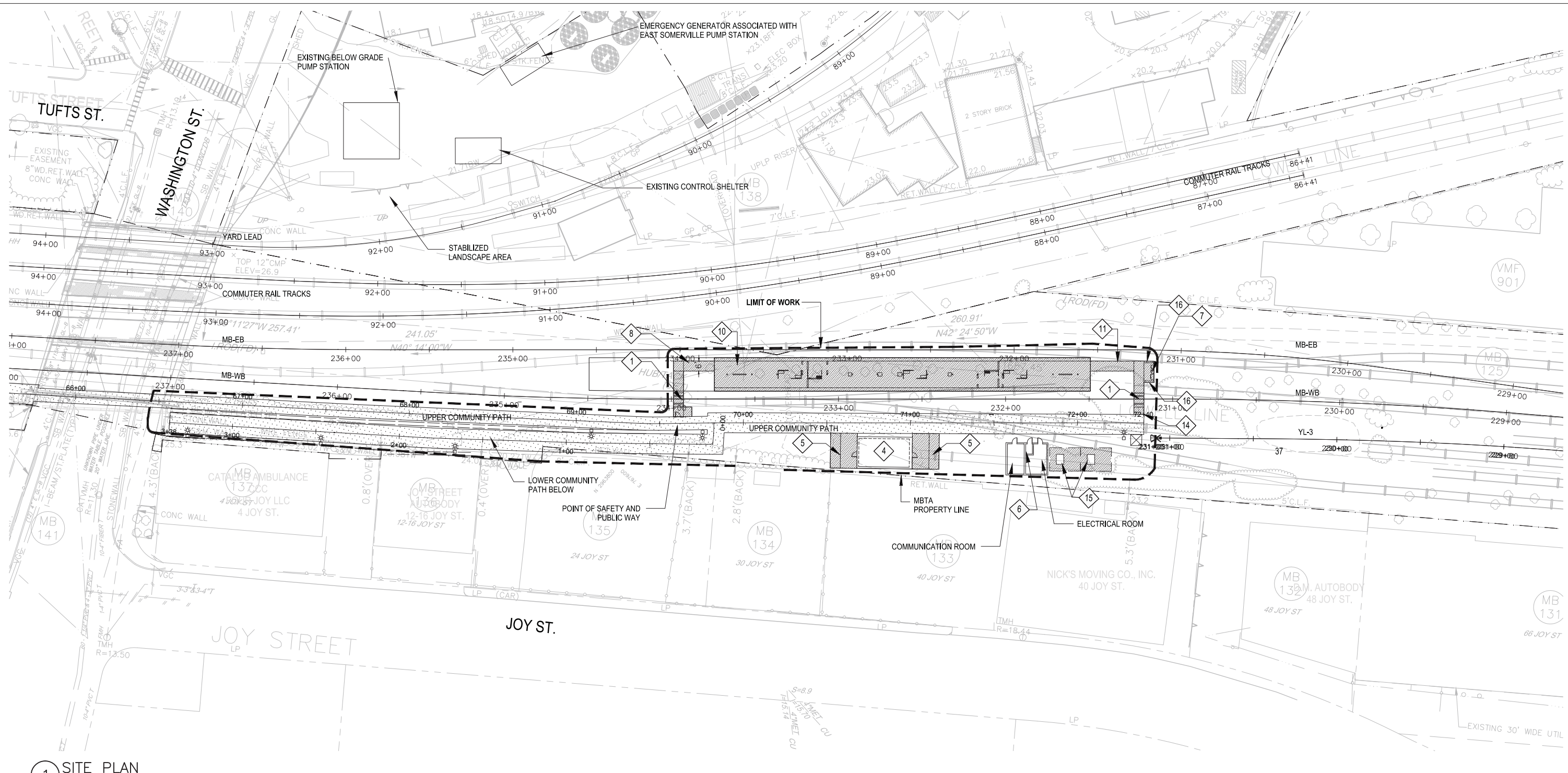

1 SITE PLAN
SCALE: 1"=30'

KEYNOTES

- | | | | |
|----|-------------------------------------|----|--|
| 1 | TRACK CROSSING | 11 | SLOPED WALK |
| 4 | BICYCLE STORAGE | 14 | ROLL UP SECURITY GRILLE W/ ADJACENT AFTER HOURS PERSONNEL GATE |
| 5 | BICYCLE RACK | 15 | TRANSFORMER |
| 6 | EFM ROOM | 16 | BENCHES |
| 7 | FARE COLLECTION MACHINES W/ 7' ROOF | | |
| 8 | EMERGENCY EGRESS SLOPED WALK | | |
| 10 | PLATFORM | | |

SHEET NOTES

- PLATFORM LENGTH TO BE 225' WITH A POTENTIAL EXTENSION OF 300'
- SEE PROPERTY LINE DRAWINGS FOR SCOPE OF WORK

LEGEND

- | | |
|--|------------------------|
| | PROPOSED CONCRETE |
| | COMMUNITY PATH ASPHALT |

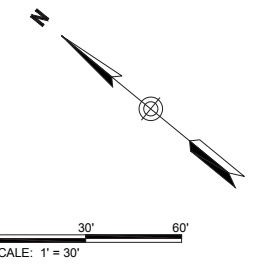

PROPOSAL

MASSACHUSETTS BAY TRANSPORTATION AUTHORITY
 GREEN LINE EXTENSION PROJECT
 MBTA CONTRACT NO. E22CN04
 CAMBRIDGE/SOMERVILLE, MASSACHUSETTS

**EAST SOMERVILLE STATION
SITE PLAN**

SCALE: AS NOTED		DRAWN BY: YQT		DESIGN BY: YQT	
DATE: SEPT 28, 2017		CHECK BY: MWR		PLAN NO.	
ISSUE		DATE		DESCRIPTION	
BY		CHK'D		APP.	
SHEET: STA-007				ISSUE	

KEYNOTES

- 10 - PLATFORM
- 11 - CUSTOMER ASSISTANCE AREA & BENCH
- 12 - SHELTER
- 14 - TACTILE EDGE
- 15 - OFFICIALS BOOTH
- 16 - EMERGENCY EGRESS SLOPED WALK
- 17 - EMERGENCY EGRESS GATE & GUARDRAIL

- 20 - SIGNAGE MAP ASSEMBLY
- 36 - LIGHT POLE
- 40 - WASTE RECEPTACLES
- 41 - SALT STORAGE BIN
- 42 - SAND STORAGE BIN
- 43 - STARTER'S BOOTH @ (UNION & COLLEGE STATION)
- 44 - VARIABLE MESSAGE SIGNS (VMS)

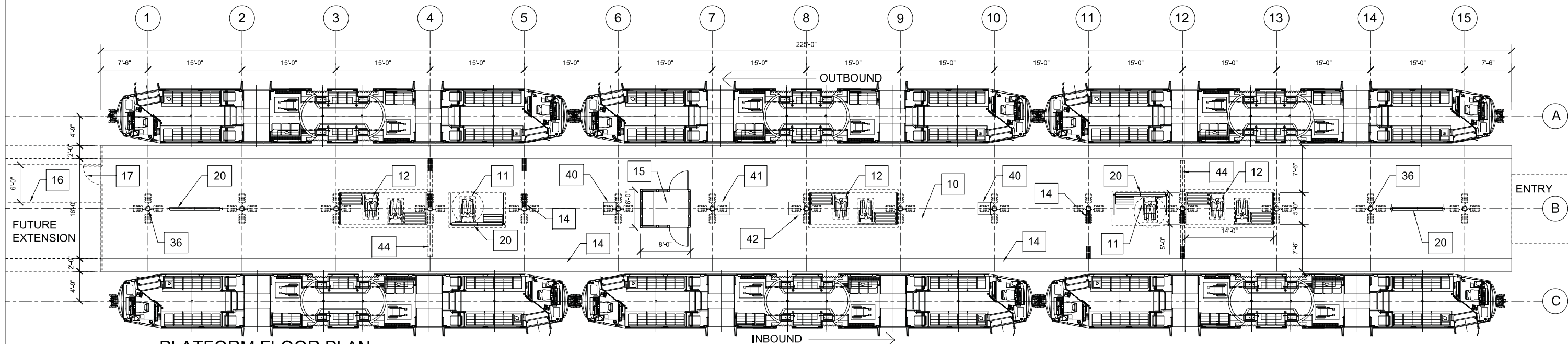
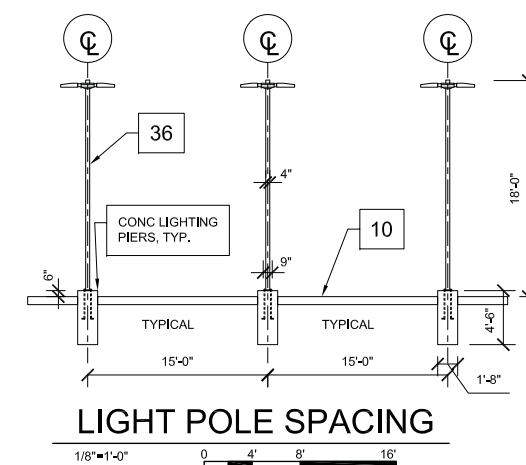
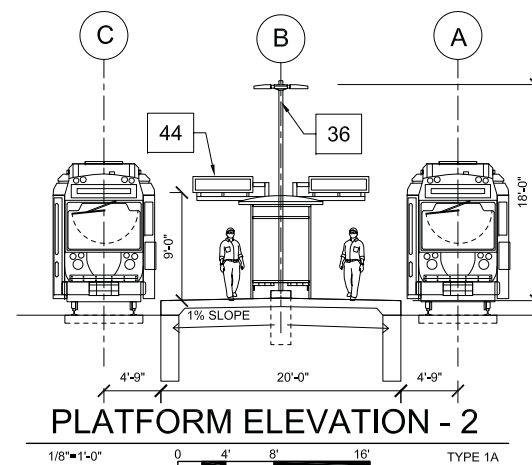

TYPE 1A
E. SOMERVILLE

PLATFORM FLOOR PLAN

1/8"=1'-0" TYPE 1A DATE: 7-14-17

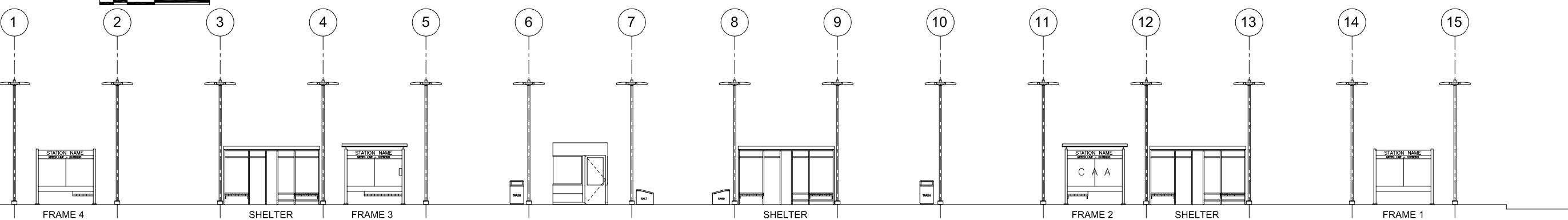

PLATFORM ELEVATION - 1

1/8"=1'-0" TYPE 1A DATE: 7-14-17

PLATFORM TYPE 1A = EAST SOMERVILLE- 20'-0" WIDE PLATFORM

PROPOSAL

MASSACHUSETTS BAY TRANSPORTATION AUTHORITY
GREEN LINE EXTENSION PROJECT
MBTA CONTRACT NO. E22CN04
CAMBRIDGE/SOMERVILLE, MASSACHUSETTS

**EAST SOMERVILLE STATION
STATION PLATFORM AT GRADE
ELEVATION AND SECTION**



GV20170258-273.pdf

SCALE: AS NOTED	DRAWN BY: PDS	DESIGN BY: PDS	CHECK BY: EMT	PLAN NO. .	ISSUE .
DATE: SEPT. 28, 2017				SHEET: STA-008	

PLOTTED: 09/14/17 11:46AM BY: TANSUO
 DRAWING: I:\PROPOSALS\2017\062820 0002 GLX GREEN LINE STATIONS\GILMAN SQUARE STATION\STA - 00 9 - GSS.DWG [SITE PLAN] 09

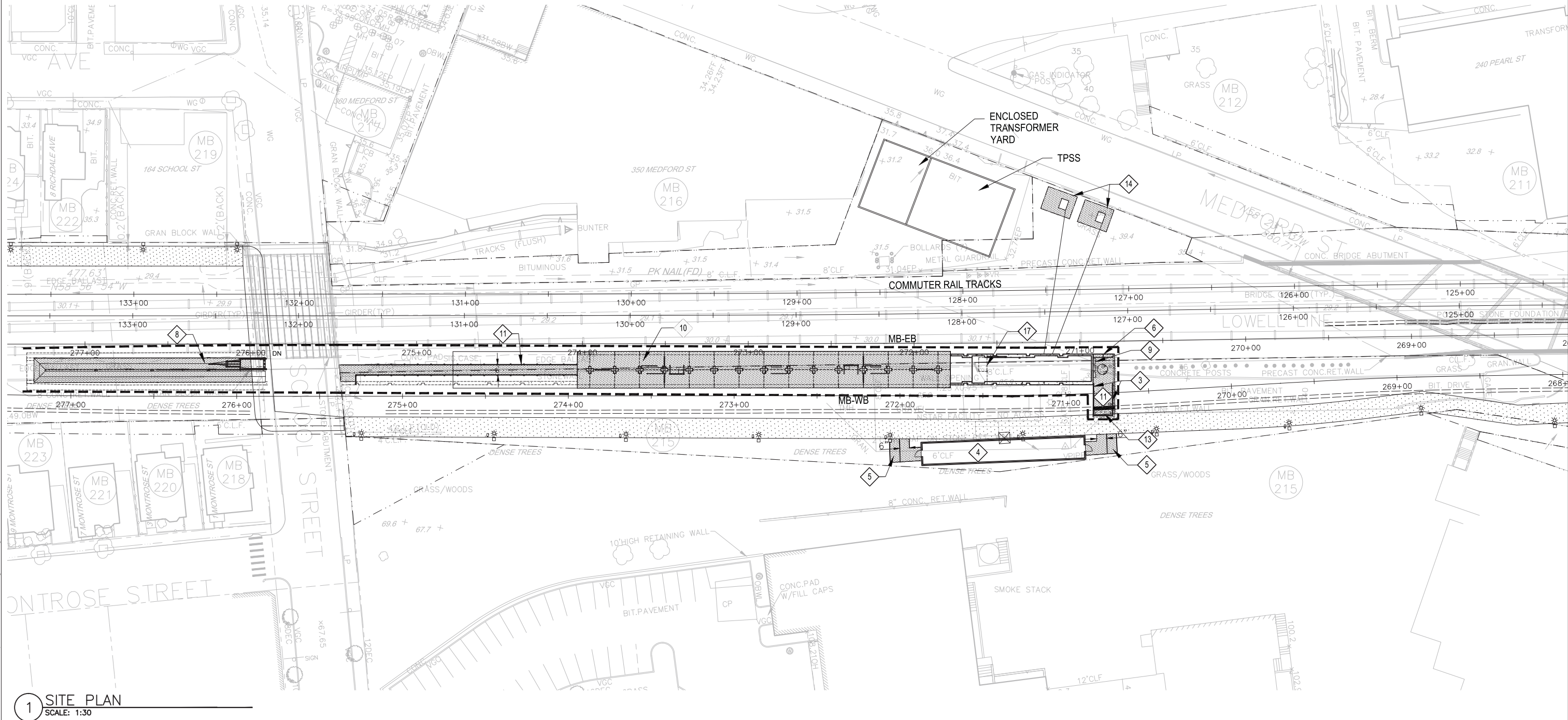

1 SITE PLAN
SCALE: 1"=30'

KEYNOTES

- 3 MISSILE BARRIER
- 4 BICYCLE STORAGE
- 5 BICYCLE RACK
- 6 BENCHES
- 8 COVERED EMERGENCY EGRESS RAMP
- 9 FARE VENDING MACHINES
- 10 PLATFORM
- 11 WALKWAY
- 13 ROLL UP SECURITY GRILL
- 14 TRANSFORMERS
- 17 ELEVATOR

SHEET NOTES

1. PLATFORM LENGTH TO BE 225' WITH A POTENTIAL EXTENSION TO 300'

LEGEND

- COMMUNITY PATH ASPHALT
- PROPOSED CONCRETE

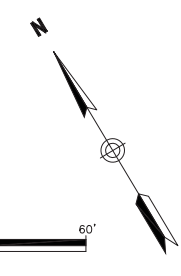

PROPOSAL

MASSACHUSETTS BAY TRANSPORTATION AUTHORITY

GREEN LINE EXTENSION PROJECT
MBTA CONTRACT NO. E22CN04
CAMBRIDGE/SOMERVILLE, MASSACHUSETTS

**GILMAN SQUARE STATION
SITE PLAN**

SCALE: AS NOTED		DRAWN BY: YQT		DESIGN BY: YQT	
DATE: SEPT 28, 2017		CHECK BY: MWR		PLAN NO.:	
ISSUE		DATE		DESCRIPTION	
BY		CHKD		APP.	
SHEET: STA-009				ISSUE	

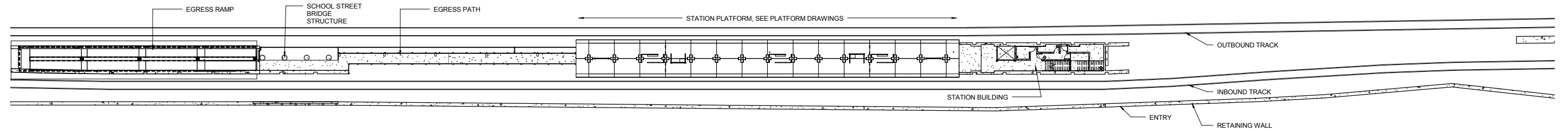

OVERALL PLAN AT PLATFORM LEVEL



1" = 30'-0"

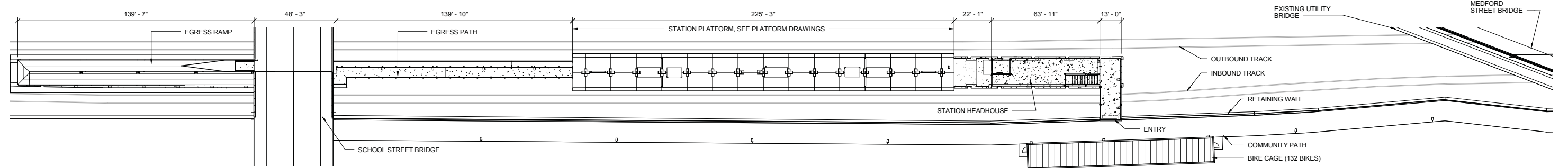

OVERALL PLAN AT STREET LEVEL



1" = 30'-0"



PROPOSAL

MASSACHUSETTS BAY TRANSPORTATION AUTHORITY
GREEN LINE EXTENSION PROJECT
MBTA CONTRACT NO. E22CN04
CAMBRIDGE/SOMERVILLE, MASSACHUSETTS

GILMAN STATION OVERALL PLANS

GV20170258-273.pdf

ISSUE	DATE	DESCRIPTION	BY	CHKD	APP.

SCALE: AS NOTED	DRAWN BY: SP	DESIGN BY: SP	CHECK BY:	PLAN NO.:	ISSUE:
DATE: SEPT. 28, 2017				SHEET: STA-010	

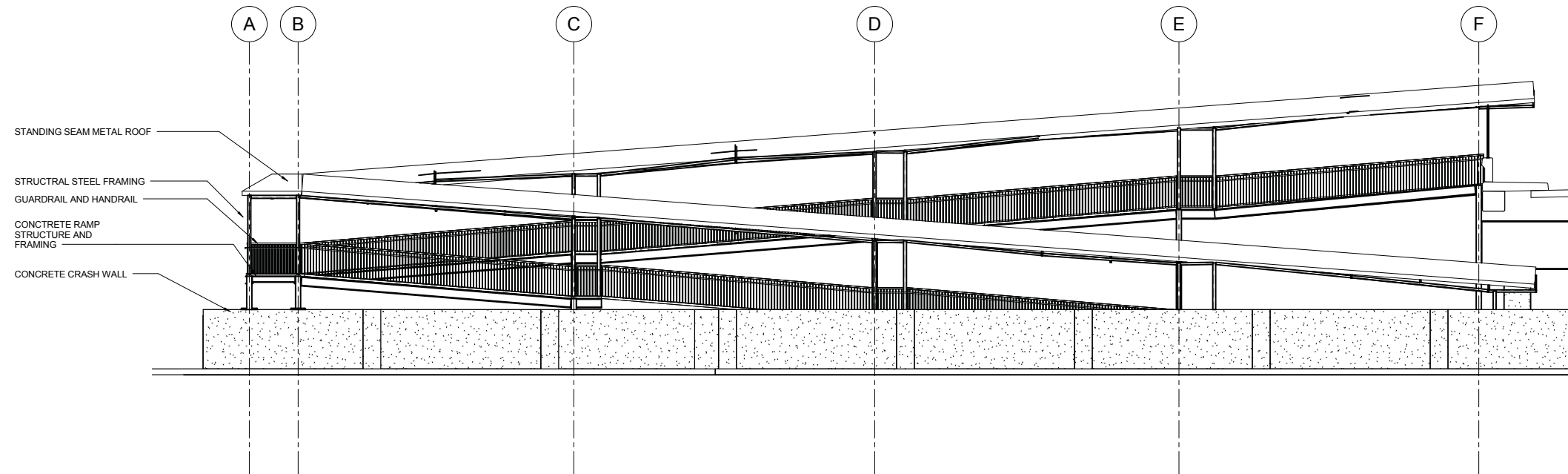

WEST ELEVATION AT
COVERED EMERGENCY
EGRESS RAMP

1
A-104 1/8" = 1'-0"

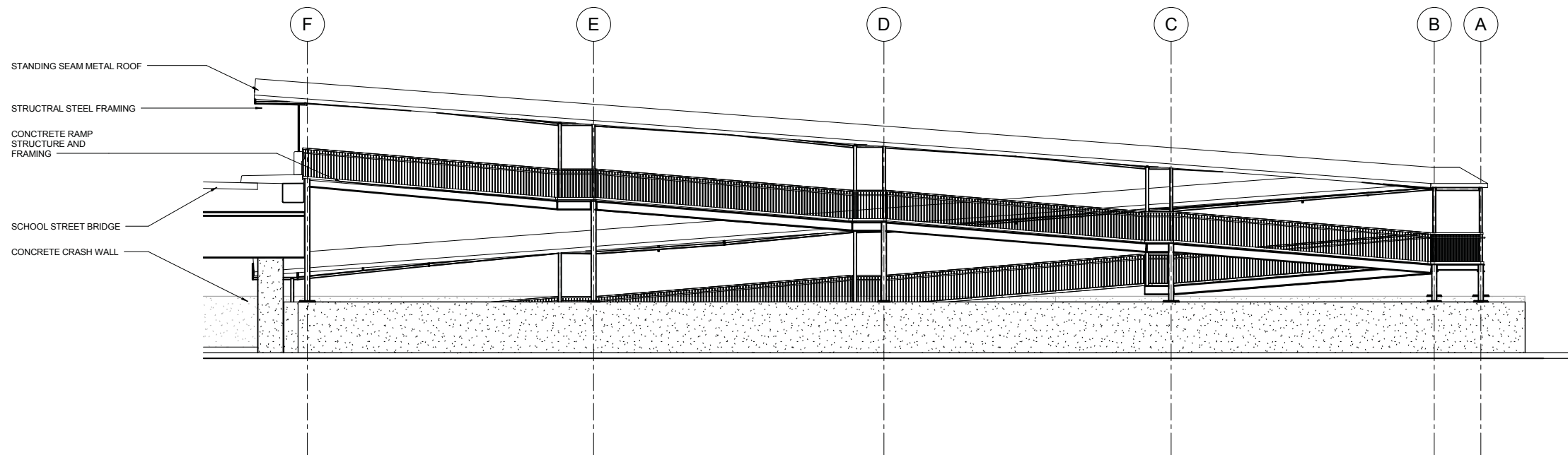

EAST ELEVATION AT
COVERED EMERGENCY
EGRESS RAMP

2
A-104 1/8" = 1'-0"

PROPOSAL

MASSACHUSETTS BAY TRANSPORTATION AUTHORITY



GREEN LINE EXTENSION PROJECT
MBTA CONTRACT NO. E22CN04
CAMBRIDGE/SOMERVILLE, MASSACHUSETTS

GILMAN STATION
COVERED EMERGENCY EGRESS
RAMP ELEVATIONS



GV20170258-273.pdf

SCALE: AS NOTED	DRAWN BY: SP	DESIGN BY: SP	CHECK BY:	PLAN NO.:	ISSUE:
DATE: SEPT. 28, 2017				SHEET: STA-011	<input type="radio"/>
ISSUE	DATE	DESCRIPTION	BY	CHKD	APP.

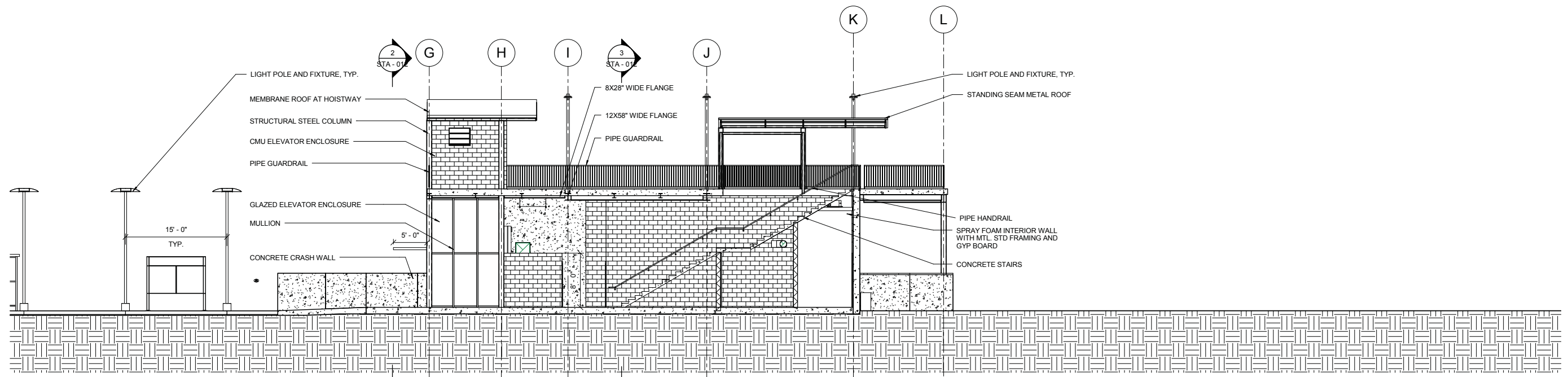

1
LONGITUDINAL SECTION
1/8" = 1'-0"

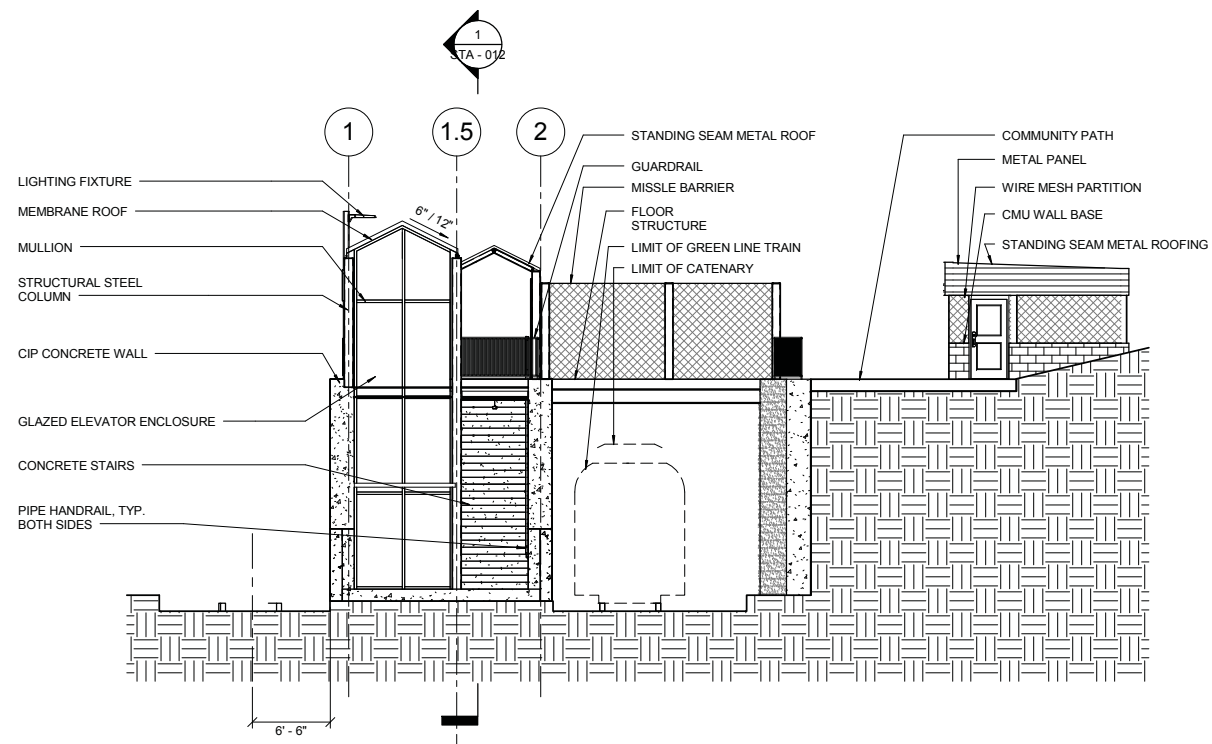

2
TRANSVERSE SECTION 1
1/8" = 1'-0"

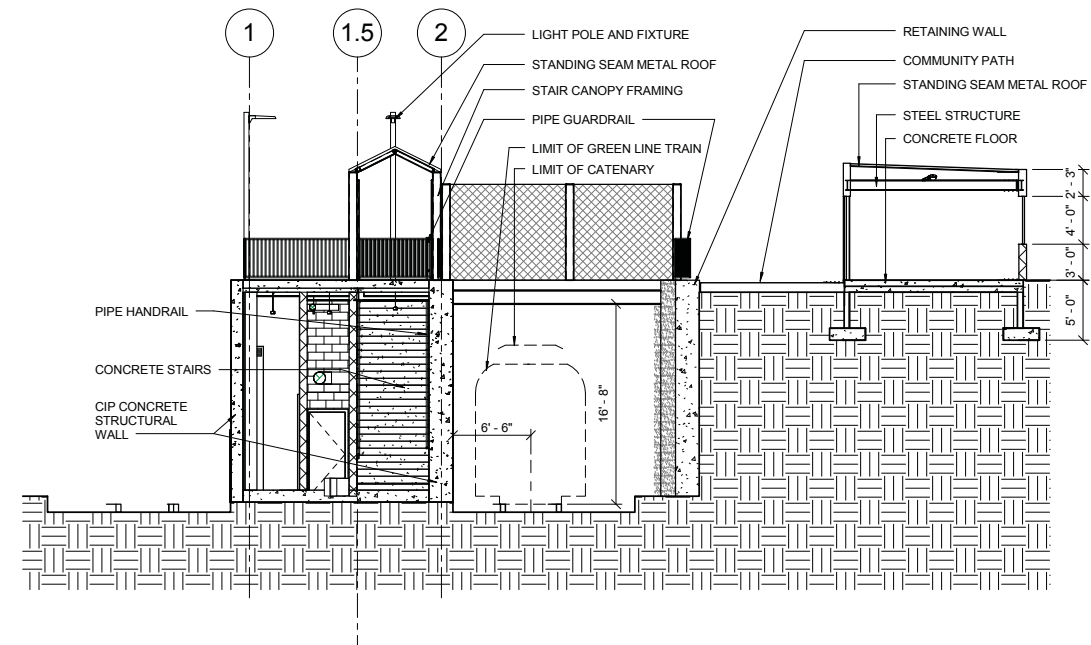

3
TRANSVERSE SECTION 2
1/8" = 1'-0"

PROPOSAL

MASSACHUSETTS BAY TRANSPORTATION AUTHORITY



GREEN LINE EXTENSION PROJECT
MBTA CONTRACT NO. E22CN04
CAMBRIDGE/SOMERVILLE, MASSACHUSETTS

**GILMAN STATION
BUILDING SECTIONS**



GV20170258-273.pdf

SCALE: AS NOTED	DRAWN BY: SP	DESIGN BY: SP	CHECK BY:	PLAN NO.	ISSUE
DATE: SEPT. 28, 2017	SP	SP		SHEET: STA-012	

ISSUE	DATE	DESCRIPTION	BY	CHKD	APP.

KEYNOTES

- 10 - PLATFORM
- 11 - CUSTOMER ASSISTANCE AREA & BENCH
- 12 - SHELTER
- 14 - TACTILE EDGE
- 15 - OFFICIALS BOOTH
- 16 - EMERGENCY EGRESS SLOPED WALK
- 17 - EMERGENCY EGRESS GATE & GUARDRAIL

- 20 - SIGNAGE MAP ASSEMBLY
- 36 - LIGHT POLE
- 40 - WASTE RECEPTACLES
- 41 - SALT STORAGE BIN
- 42 - SAND STORAGE BIN
- 43 - STARTER'S BOOTH @ (UNION & COLLEGE STATION)
- 44 - VARIABLE MESSAGE SIGNS (VMS)

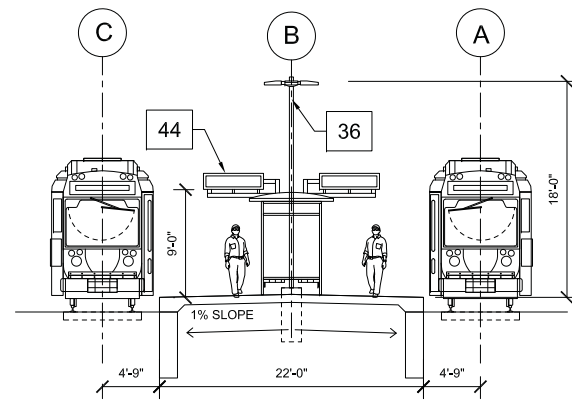

PLATFORM ELEVATION - 2

1/8"=1'-0" 0 4' 8' 16' TYPE 2A

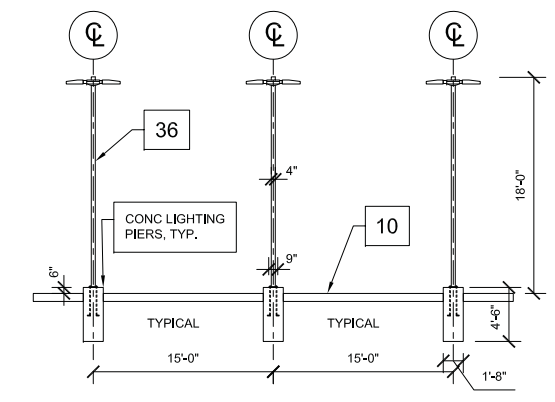

LIGHTING POLE SPACING

1/8"=1'-0" 0 4' 8' 16'

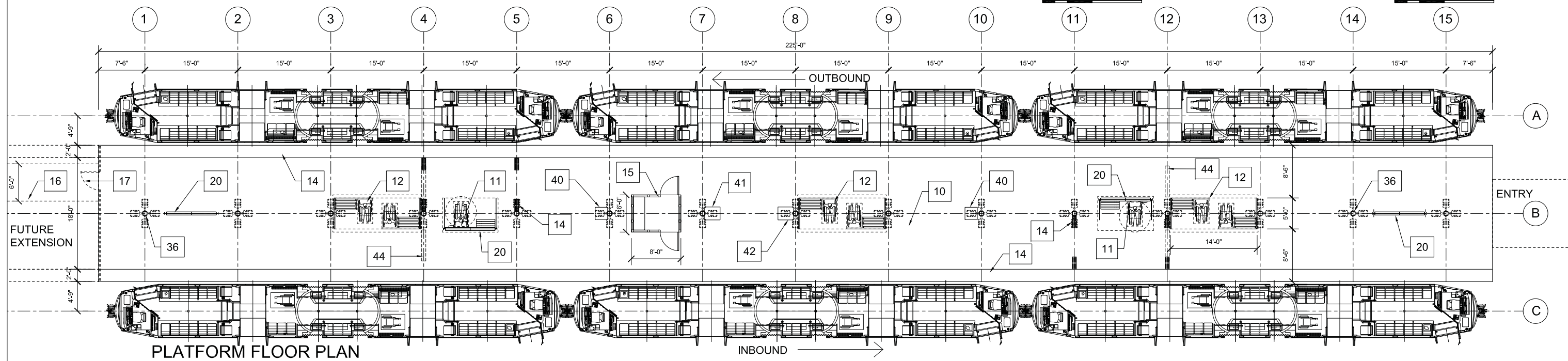

PLATFORM FLOOR PLAN

TYPE 2A-(22'-0")
GILMAN SQUARE

1/8"=1'-0" 0 4' 8' 16' TYPE 2A DATE: 7-14-17

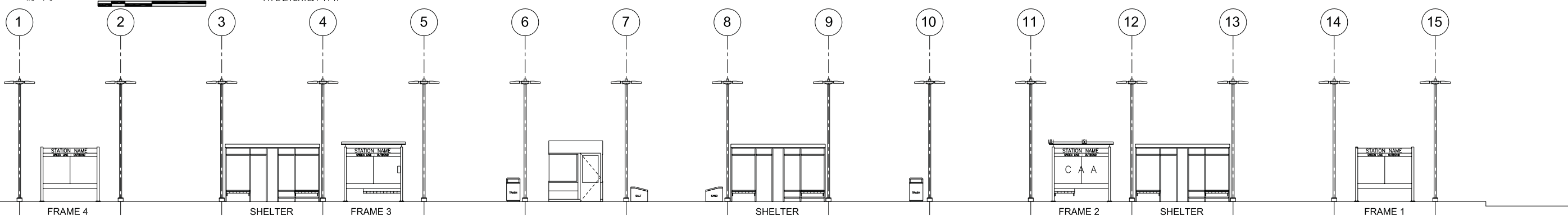

PLATFORM ELEVATION - 1

1/8"=1'-0" 0 4' 8' 16' TYPE 2A DATE: 7-14-17

PLATFORM TYPE 2A - GILMAN SQ. 22'-0" WIDE PLATFORM

PROPOSAL

MASSACHUSETTS BAY TRANSPORTATION AUTHORITY
GREEN LINE EXTENSION PROJECT
MBTA CONTRACT NO. E22CN04
CAMBRIDGE/SOMERVILLE, MASSACHUSETTS

**GILMAN STATION
STATION PLATFORM AT GRADE
ELEVATION AND SECTION**

STV 100 Years massDOT Massachusetts Department of Transportation GLX CONSTRUCTORS

SCALE: AS NOTED	DRAWN BY: PDS	DESIGN BY: PDS	CHECK BY: EMT	PLAN NO. .	ISSUE
DATE: SEPT. 28, 2017				SHEET: STA-013	

GV20170258-273.pdf

PLOTTED: 06/14/17 10:04AM BY: TANG
 DRAWING: I:\PROPOSALS\2017\062820 0002 GLX GREEN LINE STATIONS\MAGOUN SQUARE STATION STA - 014 - MESS.DWG (SITE PLAN) 09

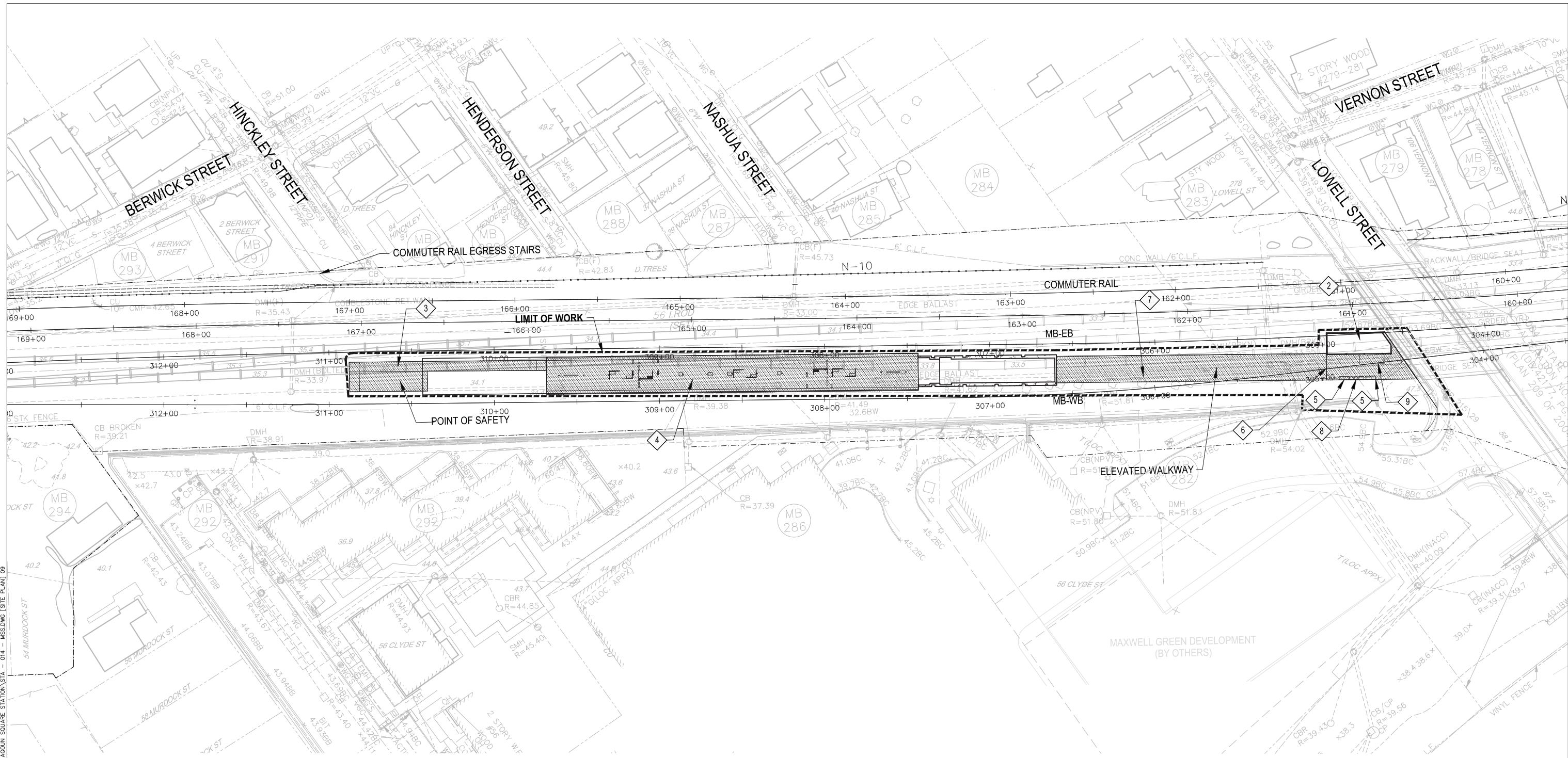

1 SITE PLAN
SCALE: 1"=30'

KEYNOTES

- 2 BICYCLE STORAGE
- 3 EMERGENCY EGRESS SLOPED WALK
- 4 PLATFORM
- 5 BENCHES
- 6 ROLL UP SECURITY GRILL
- 7 RAISED SLOPED WALKWAY
- 8 FARE MACHINES
- 9 BICYCLE RACK

SHEET NOTES

1. PLATFORM LENGTH TO BE 225' WITH A POTENTIAL EXTENSION TO 300'

LEGEND

PROPOSED CONCRETE

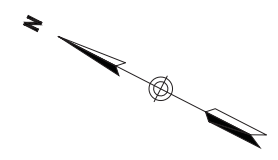

0 30' 60'
SCALE: 1" = 30'

PROPOSAL

T MASSACHUSETTS BAY TRANSPORTATION AUTHORITY
 GREEN LINE EXTENSION PROJECT
 MBTA CONTRACT NO. E22CN04
 CAMBRIDGE/SOMERVILLE, MASSACHUSETTS

**MAGOUN SQUARE STATION
SITE PLAN**



GV20170258-273.pdf

SCALE: AS NOTED	DRAWN BY: YQT	DESIGN BY: YQT	CHECK BY: MWR	PLAN NO.	ISSUE
DATE: SEPT 28, 2017				SHEET: STA-014	1
ISSUE	DATE	DESCRIPTION	BY	CHKD	APP.

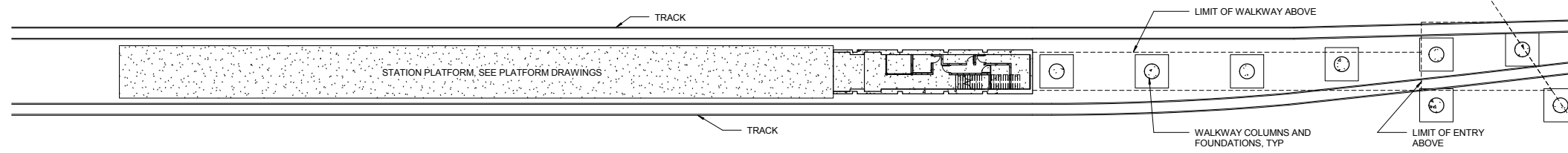

OVERALL PLAN AT PLATFORM LEVEL

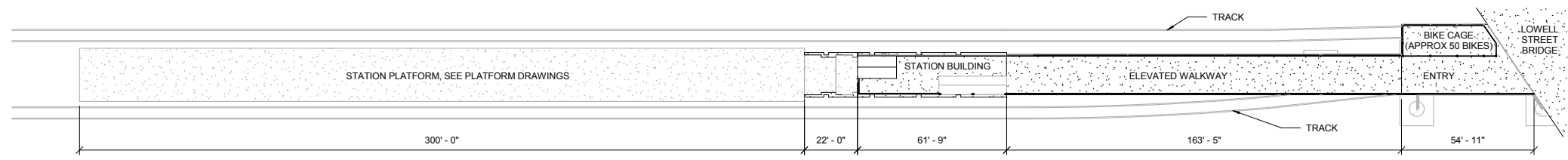
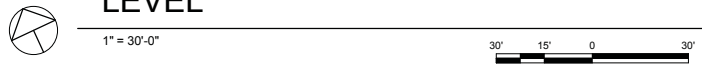

OVERALL PLAN AT STREET LEVEL

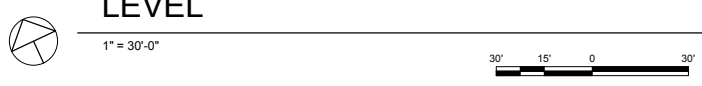

PROPOSAL

T MASSACHUSETTS BAY TRANSPORTATION AUTHORITY

GREEN LINE EXTENSION PROJECT
 MBTA CONTRACT NO. E22CN04
 CAMBRIDGE/SOMERVILLE, MASSACHUSETTS

MAGOUN STATION OVERALL PLANS



GV20170258-273.pdf

ISSUE	DATE	DESCRIPTION	BY	CHKD	APP.	SCALE: AS NOTED	DRAWN BY	DESIGN BY	CHECK BY	PLAN NO.	ISSUE
						DATE: SEPT. 28, 2017	SP	SP		SHEET: STA-015	

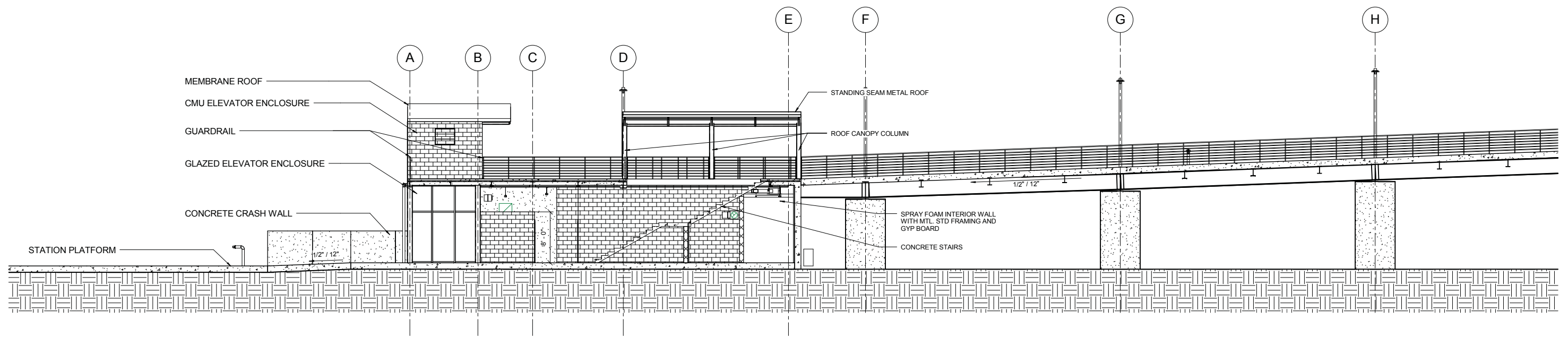

LONGITUDINAL SECTION
 2
 A-102 1/8" = 1'-0"

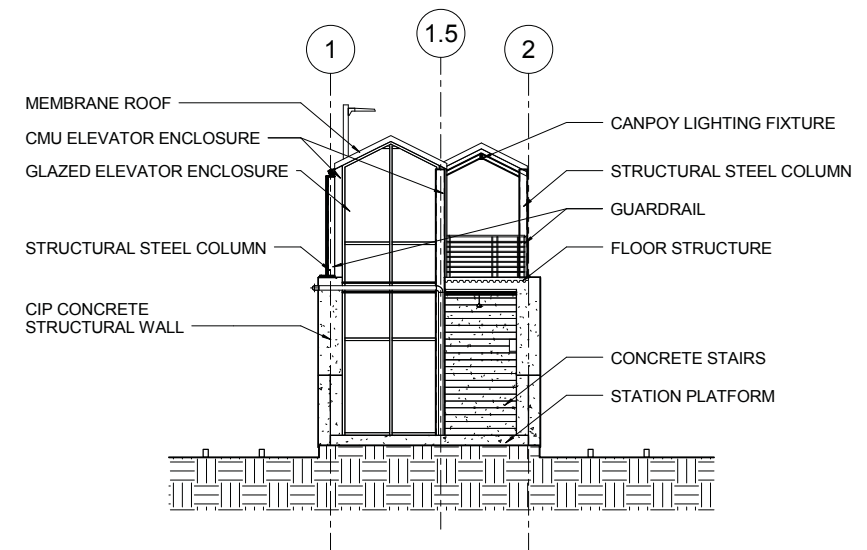

TRANSVERSE SECTION 1
 3
 A-102 1/8" = 1'-0"

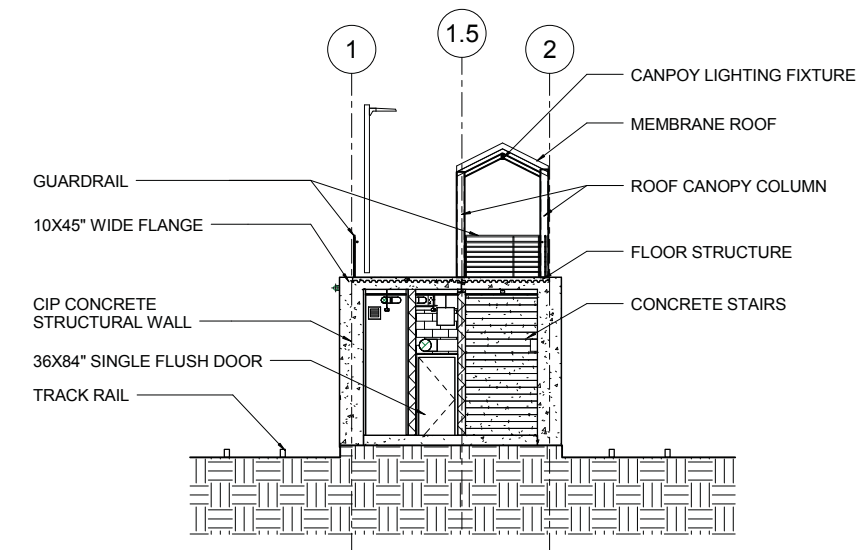

TRANSVERSE SECTION 2
 1
 A-103 1/8" = 1'-0"

PROPOSAL
 MASSACHUSETTS BAY TRANSPORTATION AUTHORITY
 GREEN LINE EXTENSION PROJECT
 MBTA CONTRACT NO. E22CN04
 CAMBRIDGE/SOMERVILLE, MASSACHUSETTS
**MAGOUN STATION
 BUILDING SECTIONS**

9/14/2017 4:14:27 PM C:\Users\shelbua\Documents\Magoun_A_300000_Shelbua.rvt

SCALE: AS NOTED DATE: SEPT. 28, 2017		DRAWN BY: SP	DESIGN BY: SP	CHECK BY:	PLAN NO.: STA-016
ISSUE	DATE	DESCRIPTION	BY	CHKD	APP.

GV20170258-273.pdf

KEYNOTES

- 10 - PLATFORM
- 11 - CUSTOMER ASSISTANCE AREA & BENCH
- 12 - SHELTER
- 14 - TACTILE EDGE
- 15 - OFFICIALS BOOTH
- 16 - EMERGENCY EGRESS SLOPED WALK
- 17 - EMERGENCY EGRESS GATE & GUARDRAIL

- 20 - SIGNAGE MAP ASSEMBLY
- 36 - LIGHT POLE
- 40 - WASTE RECEPTACLES
- 41 - SALT STORAGE BIN
- 42 - SAND STORAGE BIN
- 43 - STARTER'S BOOTH @ (UNION & COLLEGE STATION)
- 44 - VARIABLE MESSAGE SIGNS (VMS)

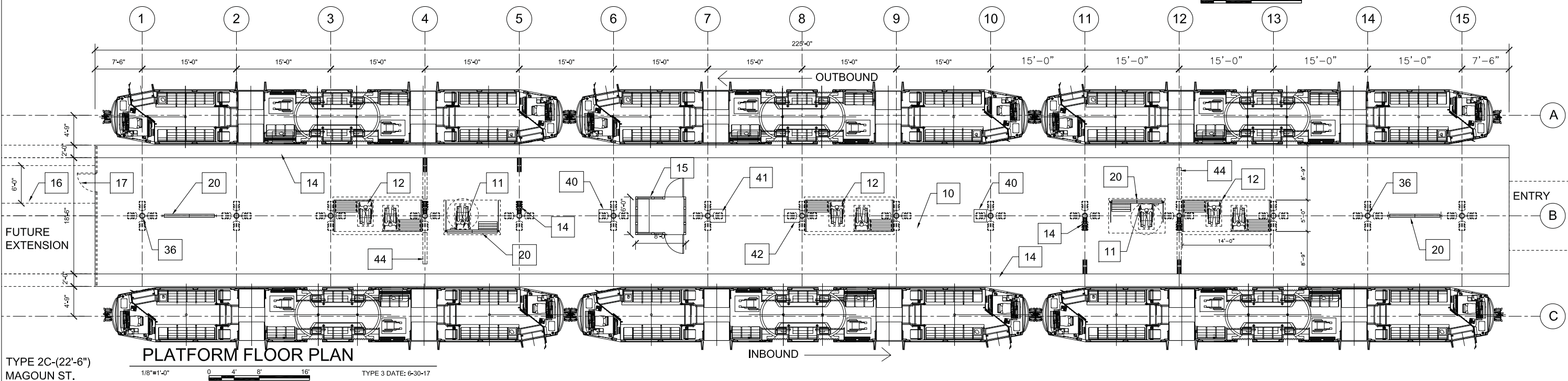
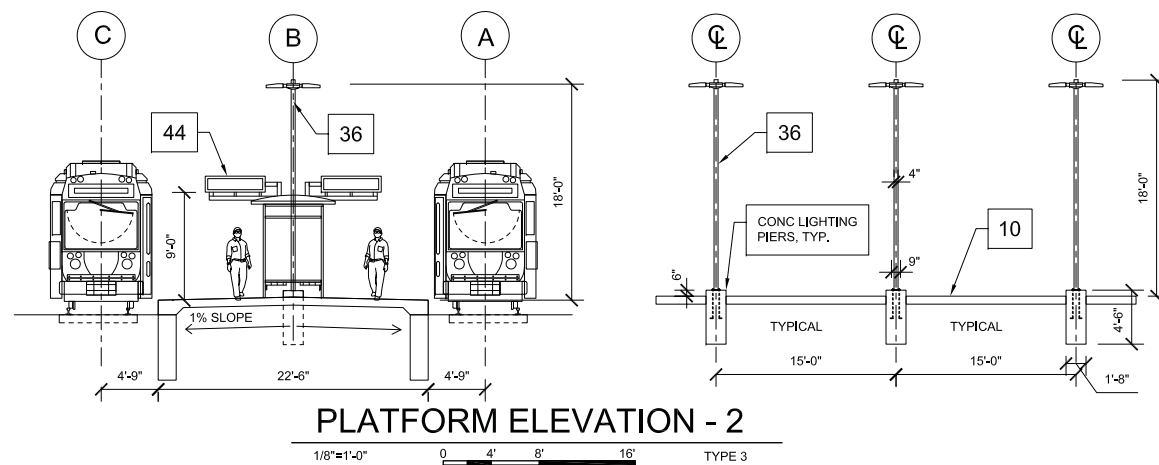

PLATFORM FLOOR PLAN

TYPE 2C-(22'-6")
MAGOUN ST.

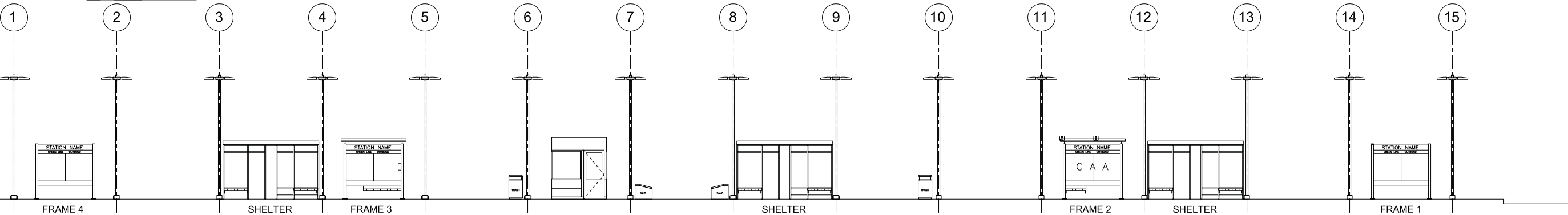

PLATFORM ELEVATION - 1

PLATFORM TYPE 2C - MAGOUN SQUARE STATION - 22'-6" WIDE PLATFORM

PROPOSAL



MASSACHUSETTS BAY TRANSPORTATION AUTHORITY
GREEN LINE EXTENSION PROJECT
MBTA CONTRACT NO. E22CN04
CAMBRIDGE/SOMERVILLE, MASSACHUSETTS

**MAGOUN STATION
STATION PLATFORM AT GRADE
ELEVATION AND SECTION**



GV20170258-273.pdf

SCALE: AS NOTED	DRAWN BY: PDS	DESIGN BY: PDS	CHECK BY: EMT	PLAN NO. .	ISSUE
DATE: SEPT. 28, 2017				SHEET: STA-017	

PLOTTED: 09/14/17 11:38AM BY: TANUSO
 DRAWING: I:\PROJ\03\13\2017\062820 0002 GLX GREEN LINE STATIONS\CIVIL SITE DRAWINGS\BALL SQUARE STATION\STA - 018 - BAS.DWG (SITE PLAN) 09/17

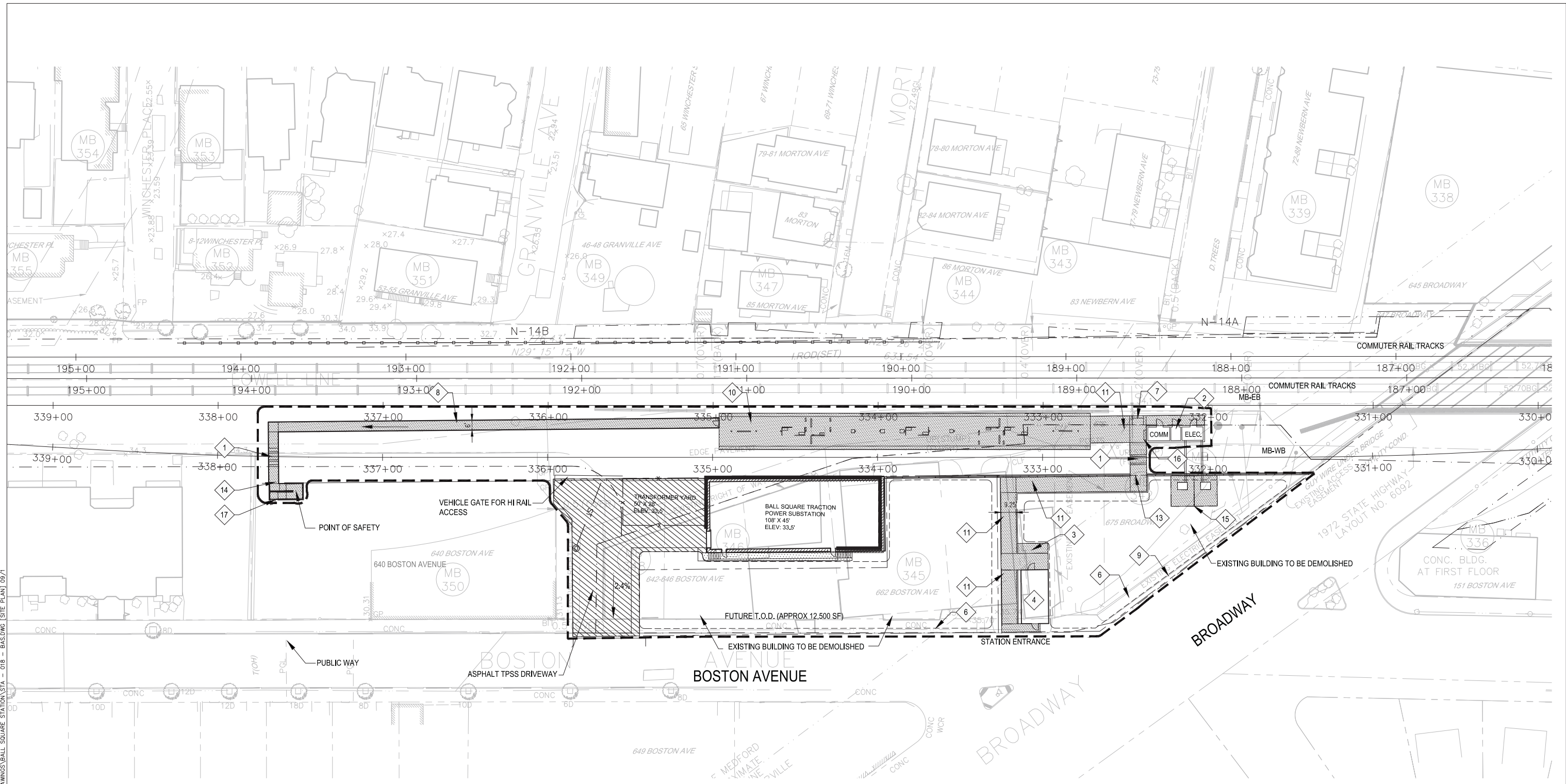

1 SITE PLAN
SCALE: 1"=30'

- KEYNOTES**
- | | | | |
|---|-------------------------------------|----|--|
| 1 | TRACK CROSSING | 10 | PLATFORM |
| 2 | EFM ROOM | 11 | SLOPED WALK |
| 3 | BICYCLE RACK | 13 | ROLL UP SECURITY GRILLE W/ ADJACENT AFTER HOURS PERSONNEL GATE |
| 4 | BICYCLE STORAGE | 14 | EMERGENCY EGRESS RAMP |
| 6 | GRAVEL | 15 | TRANSFORMERS |
| 7 | FARE COLLECTION MACHINES W/ 7' ROOF | 16 | BENCHES |
| 8 | EMERGENCY EGRESS SLOPED WALK | 17 | EMERGENCY EGRESS GATE |
| 9 | CONCRETE SIDEWALK - BROOM FINISH | | |

SHEET NOTES

1. PLATFORM LENGTH TO BE 225' WITH A POTENTIAL EXTENSION TO 300'.

- LEGEND**
- | | |
|--|---------------------------|
| | PROPOSED CONCRETE |
| | PROPOSED ASPHALT PAVEMENT |

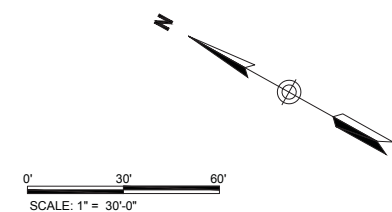

PROPOSAL

MASSACHUSETTS BAY TRANSPORTATION AUTHORITY

T

GREEN LINE EXTENSION PROJECT
 MBTA CONTRACT NO. E22CN04
 CAMBRIDGE/SOMERVILLE, MASSACHUSETTS

BALL SQUARE STATION
SITE PLAN - STREET LEVEL

		GV20170258-273.pdf SCALE: AS NOTED DATE: SEPT 28, 2017		DRAWN BY: YQT DESIGN BY: YQT CHECK BY: MWR		PLAN NO. SHEET: STA-018		ISSUE
ISSUE	DATE	DESCRIPTION	BY	CHKD	APP.			

KEYNOTES

- 10 - PLATFORM
- 11 - CUSTOMER ASSISTANCE AREA & BENCH
- 12 - SHELTER
- 14 - TACTILE EDGE
- 15 - OFFICIALS BOOTH
- 16 - EMERGENCY EGRESS SLOPED WALK
- 17 - EMERGENCY EGRESS GATE & GUARDRAIL

- 20 - SIGNAGE MAP ASSEMBLY
- 36 - LIGHT POLE
- 40 - WASTE RECEPTACLES
- 41 - SALT STORAGE BIN
- 42 - SAND STORAGE BIN
- 43 - STARTER'S BOOTH @ (UNION & COLLEGE STATION)
- 44 - VARIABLE MESSAGE SIGNS (VMS)

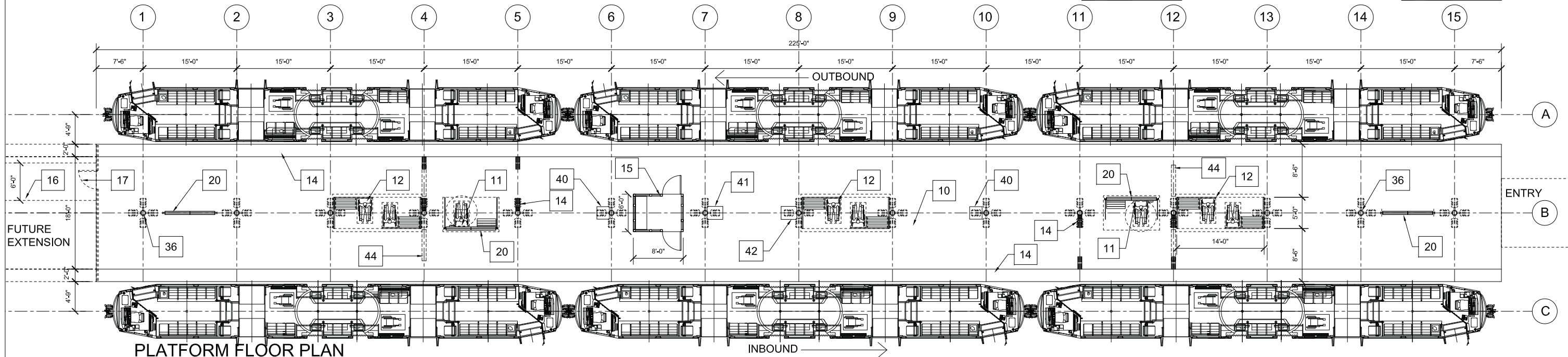
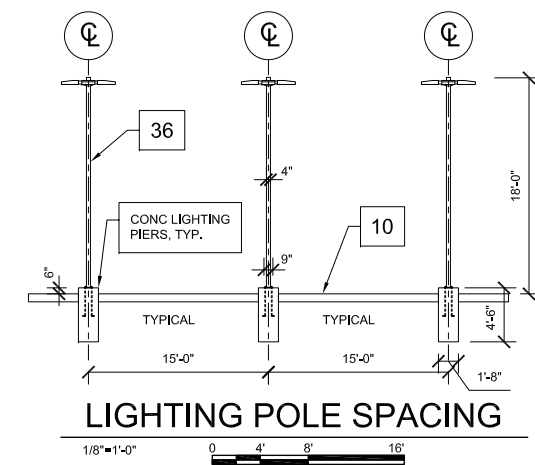
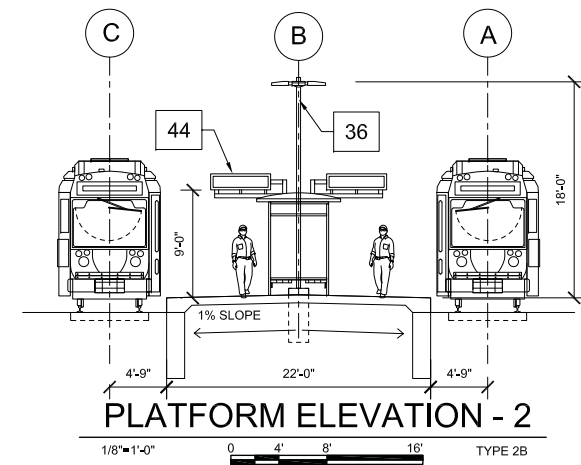

TYPE 2B-(22'-0")
BALL SQ.

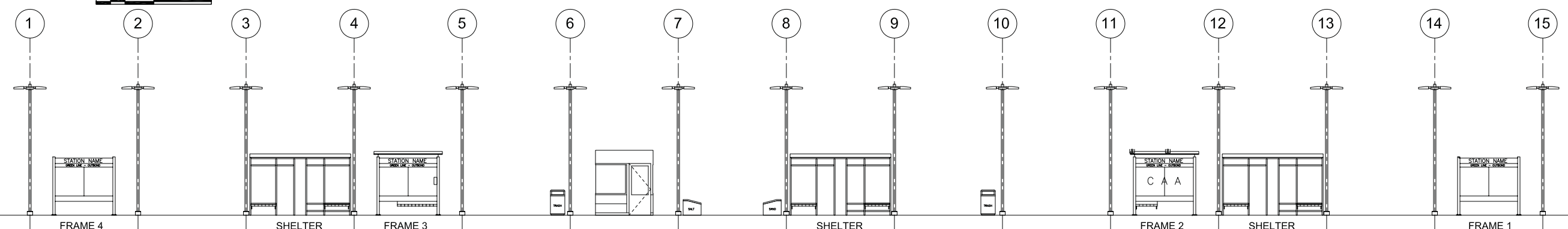

PLATFORM ELEVATION - 1
1/8"=1'-0" TYPE 2B DATE: 7-14-17

PLATFORM TYPE 2B - BALL SQUARE - 22'-0" WIDE PLATFORM

PROPOSAL

MASSACHUSETTS BAY TRANSPORTATION AUTHORITY
GREEN LINE EXTENSION PROJECT
MBTA CONTRACT NO. E22CN04
CAMBRIDGE/SOMERVILLE, MASSACHUSETTS

**BALL SQUARE STATION
STATION PLATFORM AT GRADE
ELEVATION AND SECTION**

SCALE: AS NOTED		DRAWN BY: PDS	DESIGN BY: PDS	CHECK BY: EMT	PLAN NO.: .
ISSUE:	DATE:	DESCRIPTION:	BY:	CHKD:	APP:
DATE: SEPT. 28, 2017				SHEET: STA-019	ISSUE:

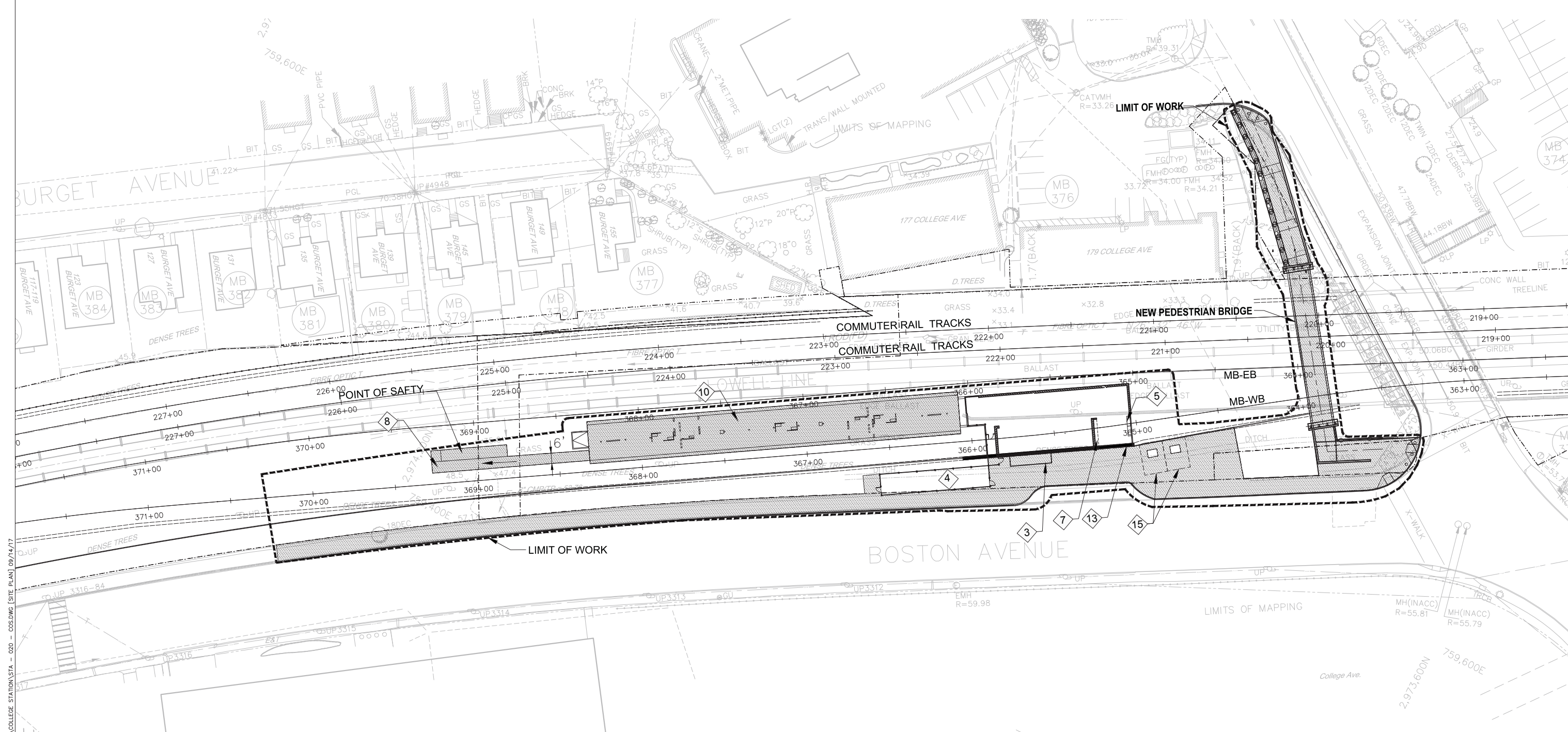

1 SITE PLAN
SCALE: 1"=30'

KEYNOTES

- 3 BICYCLE RACK
- 4 BICYCLE STORAGE
- 5 BENCHES
- 7 FARE VENDING MACHINES W/9' ROOF
- 8 EMERGENCY EGRESS SLOPED WALK
- 10 PLATFORM
- 13 ROLL UP SECURITY GRILLE
- 15 TRANSFORMER

SHEET NOTES

1. PLATFORM LENGTH TO BE 225' WITH A POTENTIAL EXTENSION TO 300'.
2. SEE PROPERTY LINE DRAWINGS FOR LIMIT OF WORK

LEGEND

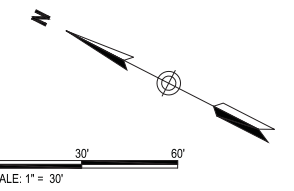

PROPOSAL

MASSACHUSETTS BAY TRANSPORTATION AUTHORITY
T
 GREEN LINE EXTENSION PROJECT
 MBTA CONTRACT NO. E22CN04
 CAMBRIDGE/SOMERVILLE, MASSACHUSETTS

**COLLEGE AVENUE STATION
 SITE PLAN - STREET LEVEL**



SCALE: AS NOTED	DRAWN BY: YQT	DESIGN BY: YQT	CHECK BY: MWR	PLAN NO.	ISSUE
DATE: SEPT 28, 2017				SHEET: STA-020	
ISSUE	DATE	DESCRIPTION	BY	CHKD	APP.

PLOTTED: 09/14/17 11:46AM BY: TANUSO
 DRAWING: I:\PROPOSALS\2017\062820 0002 GLX GREEN LINE STATIONS\CIVIL SITE DRAWINGS\COLLEGE STATION\STA - 020 - GCS.DWG [SITE PLAN] 09/14/17

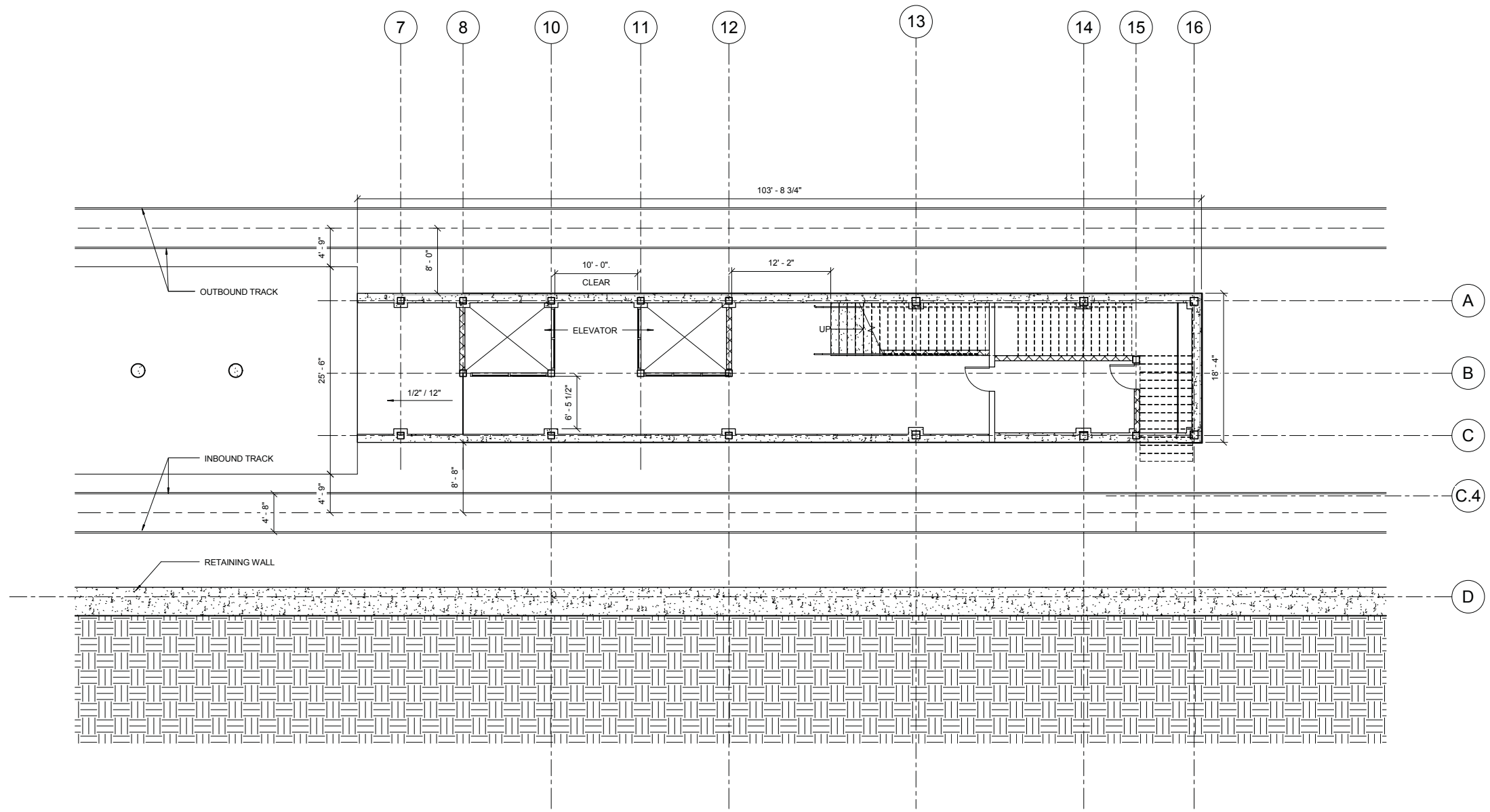

**STATION PLATFORM -
HEADHOUSE**



1/8" = 1'-0"

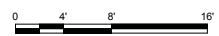

PROPOSAL

MASSACHUSETTS BAY TRANSPORTATION AUTHORITY
T
 GREEN LINE EXTENSION PROJECT
 MBTA CONTRACT NO. E22CN04
 CAMBRIDGE/SOMERVILLE, MASSACHUSETTS

**COLLEGE STATION
STATION PLATFORM FLOOR PLAN**



GV20170258-273.pdf

ISSUE	DATE	DESCRIPTION	BY	CHKD	APP.	SCALE:	DATE:	DRAWN BY:	DESIGN BY:	CHECK BY:	PLAN NO.:	ISSUE
						AS NOTED	SEPT. 28, 2017	SP	SP		STA-021	

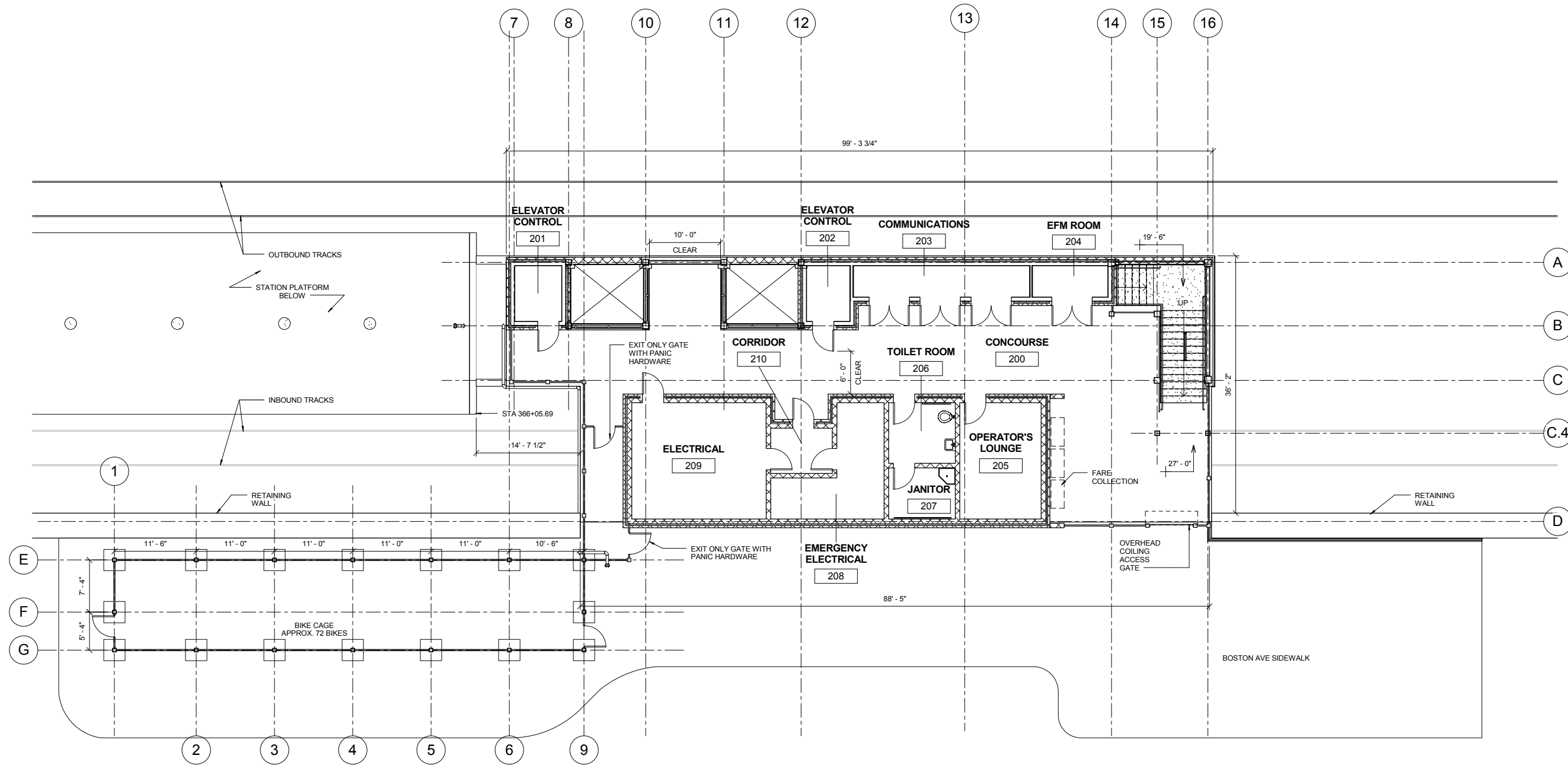

STATION HEADHOUSE - STREET LEVEL

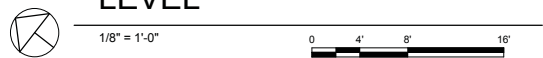

PROPOSAL

MASSACHUSETTS BAY TRANSPORTATION AUTHORITY
T
 GREEN LINE EXTENSION PROJECT
 MBTA CONTRACT NO. E22CN04
 CAMBRIDGE/SOMERVILLE, MASSACHUSETTS

**COLLEGE STATION
 BOSTON AVE FLOOR PLAN**



GV20170258-273.pdf

ISSUE	DATE	DESCRIPTION	BY	CHKD	APP.	SCALE:	DRAWN BY	DESIGN BY	CHECK BY	PLAN NO.	ISSUE
						AS NOTED	SP	SP		STA-022	

DATE: SEPT. 28, 2017

SHEET: STA-022

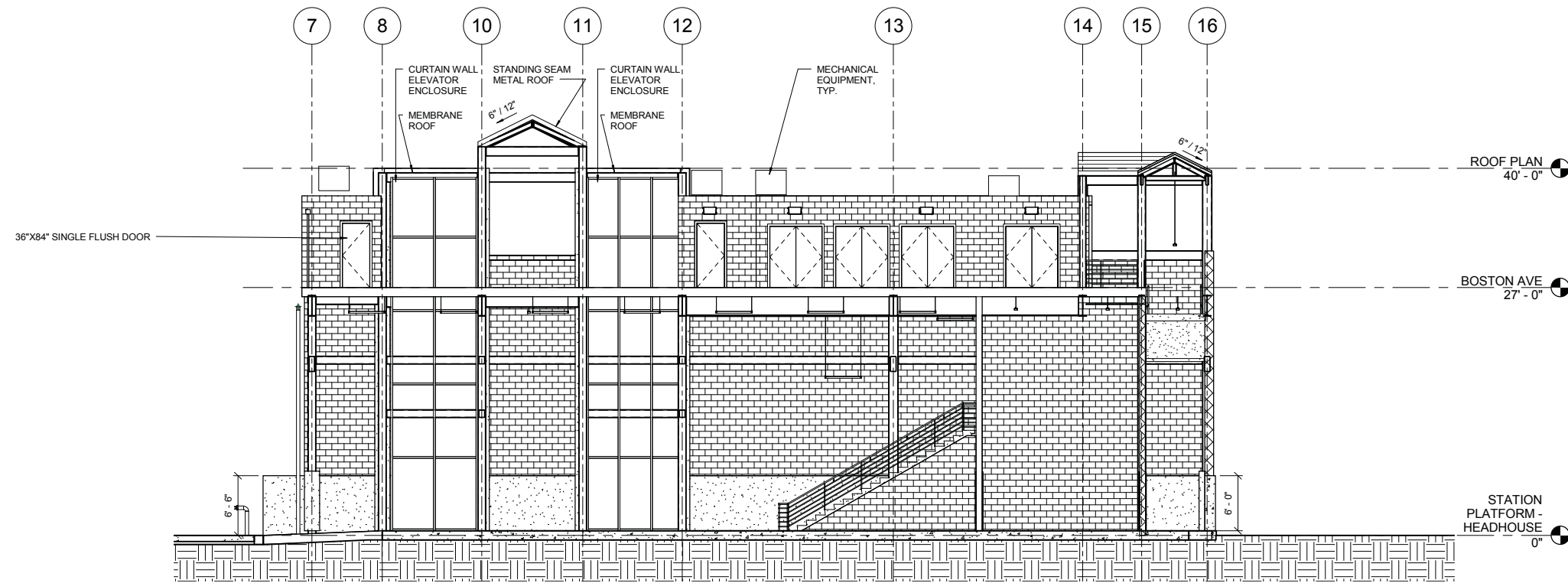

1
A-105
LONGITUDINAL SECTION 1
1/8" = 1'-0"

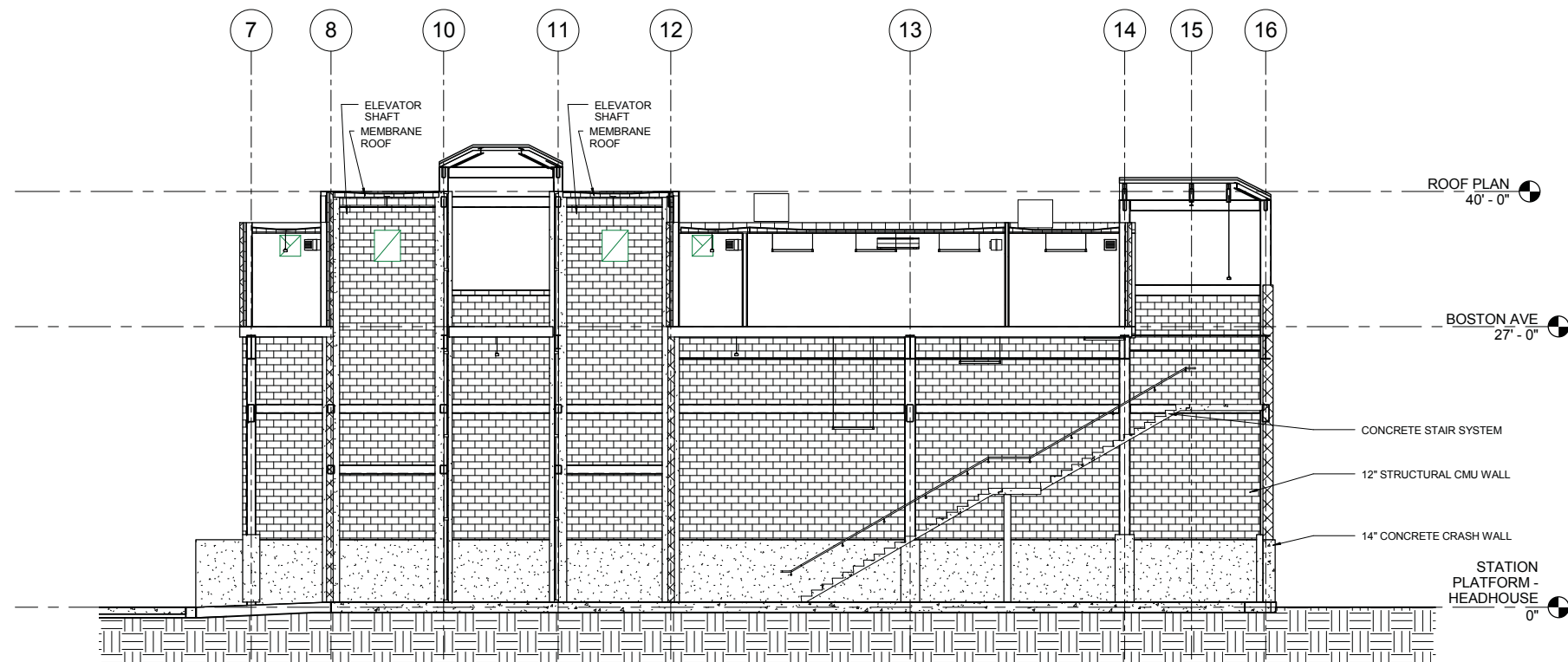

2
A-105
LONGITUDINAL SECTION 2
1/8" = 1'-0"

PROPOSAL
 MASSACHUSETTS BAY TRANSPORTATION AUTHORITY
 GREEN LINE EXTENSION PROJECT
 MBTA CONTRACT NO. E22CN04
 CAMBRIDGE/SOMERVILLE, MASSACHUSETTS

**COLLEGE STATION
 BUILDING SECTIONS**



GV20170258-273.pdf

SCALE: AS NOTED	DRAWN BY: SP	DESIGN BY: SP	CHECK BY:	PLAN NO.:	ISSUE:
DATE: SEPT. 28, 2017				SHEET: STA-023	
ISSUE	DATE	DESCRIPTION	BY	CHKD	APP.

KEYNOTES

- 10 - PLATFORM
- 11 - CUSTOMER ASSISTANCE AREA & BENCH
- 12 - SHELTER
- 14 - TACTILE EDGE
- 15 - OFFICIALS BOOTH
- 16 - EMERGENCY EGRESS SLOPED WALK
- 17 - EMERGENCY EGRESS GATE & GUARDRAIL

- 20 - SIGNAGE MAP ASSEMBLY
- 36 - LIGHT POLE
- 40 - WASTE RECEPTACLES
- 41 - SALT STORAGE BIN
- 42 - SAND STORAGE BIN
- 43 - STARTER'S BOOTH @ (UNION & COLLEGE STATION)
- 44 - VARIABLE MESSAGE SIGNS (VMS)

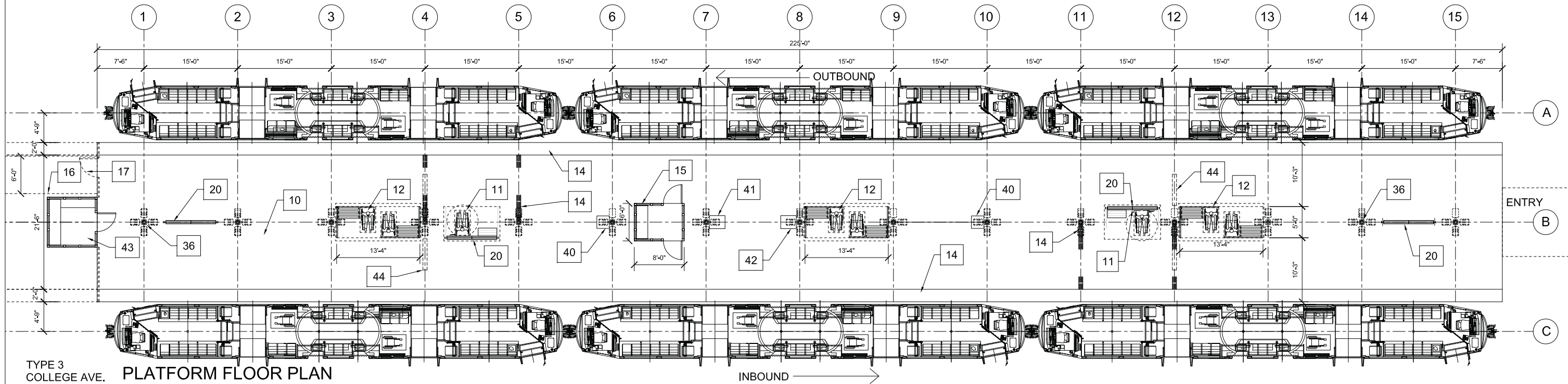
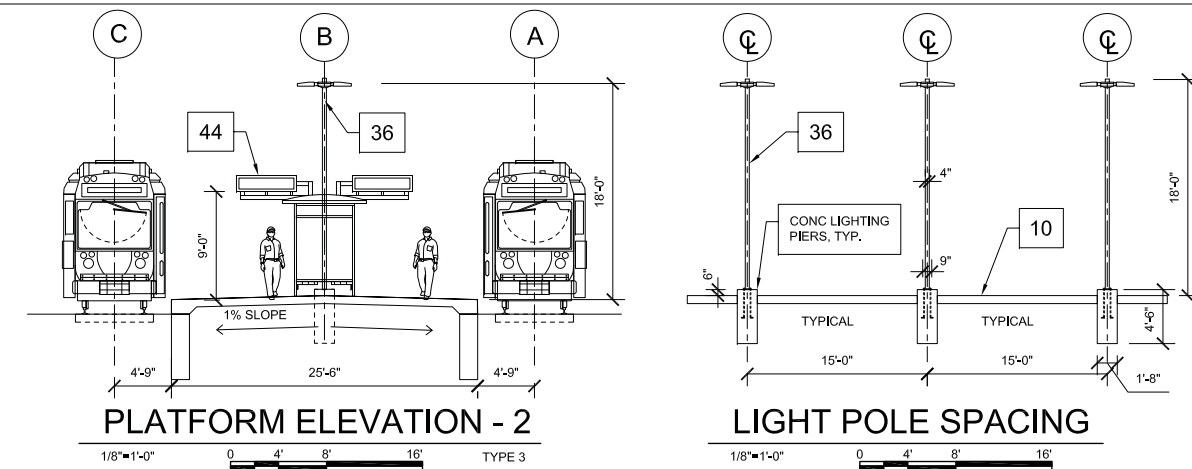

TYPE 3
COLLEGE AVE.

PLATFORM FLOOR PLAN

1/8"=1'-0" 0 4' 8' 16' TYPE 3 DATE: 7-14-17

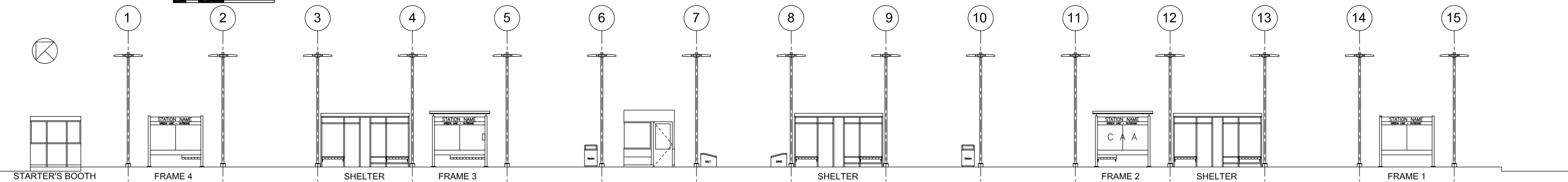

PLATFORM ELEVATION - 1

1/8"=1'-0" 0 4' 8' 16' TYPE 3 DATE: 7-14-17

PLATFORM TYPE 3 - COLLEGE AVE. - 25'-6" WIDE PLATFORM

PROPOSAL



MASSACHUSETTS BAY TRANSPORTATION AUTHORITY
GREEN LINE EXTENSION PROJECT
MBTA CONTRACT NO. E22CN04
CAMBRIDGE/SOMERVILLE, MASSACHUSETTS

**COLLEGE STATION
STATION PLATFORM AT GRADE
ELEVATION AND SECTION**



GV20170258-273.pdf

SCALE: AS NOTED	DRAWN BY	DESIGN BY	CHECK BY	PLAN NO.	ISSUE
DATE: SEPT. 28, 2017	PDS	PDS	EMT	SHEET: STA-024	
ISSUE	DATE	DESCRIPTION	BY	CHKD	APP.

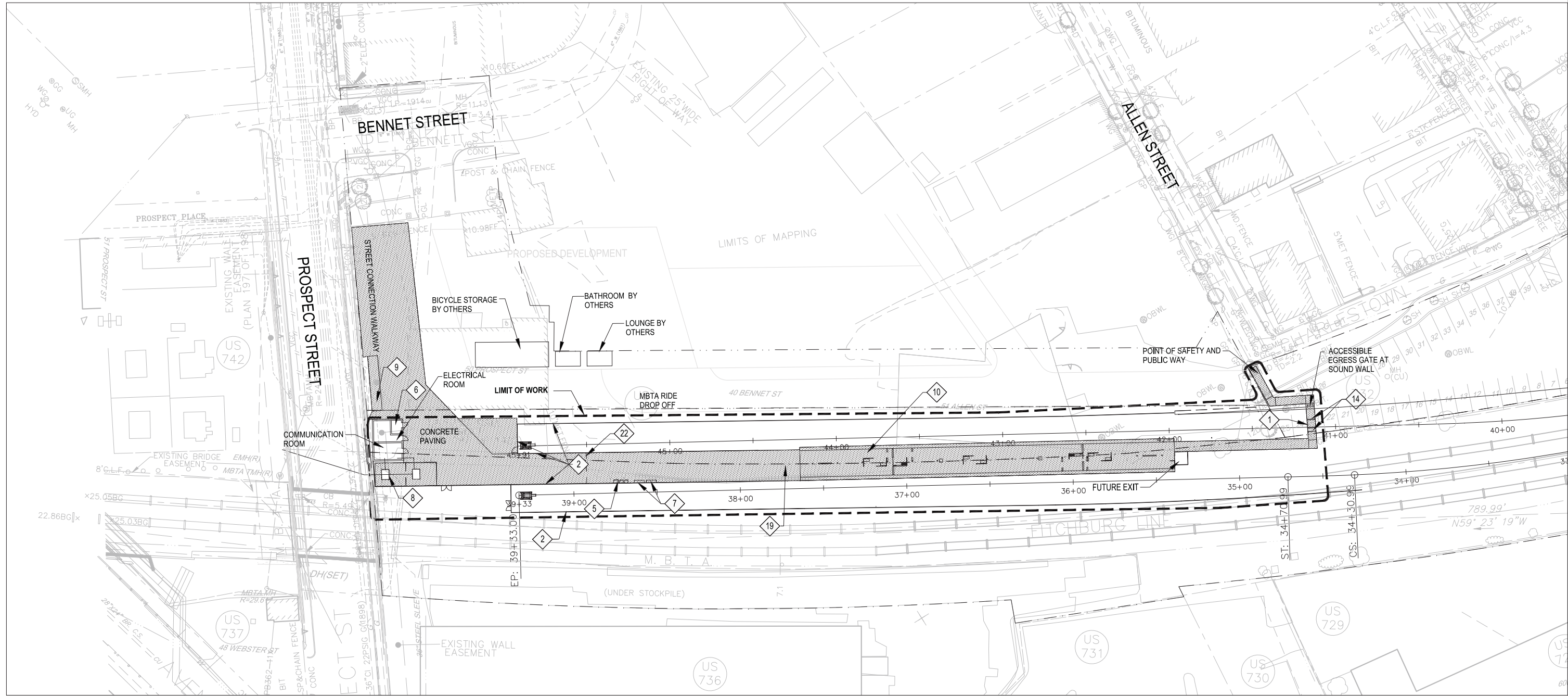

1 SITE PLAN
SCALE: 1"=30'-0"

KEYNOTES

- 1 TRACK CROSSING
- 2 CHAINLINK FENCE
- 4 BICYCLE STORAGE
- 5 FARE VENDING MACHINES W/ 9' ROOF
- 6 EFM ROOM
- 7 BENCHES
- 8 TRANSFORMER
- 9 BICYCLE RACK

- 10 PLATFORM
- 14 2 FT WIDE TACTILE EDGE
- 19 SLOPED WALKWAY
- 22 ROLL UP SECURITY GRILLE W/ ADJACENT AFTER HOURS PERSONNEL GATE

SHEET NOTES

1 PLATFORM LENGTH TO BE 225' WITH A POTENTIAL EXTENSION TO 300'

LEGEND

PROPOSED CONCRETE

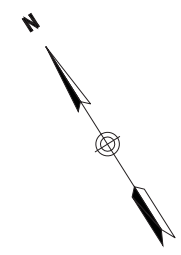

0' 30' 60'
SCALE: 1"= 30'-0"

PROPOSAL
MASSACHUSETTS BAY TRANSPORTATION AUTHORITY
T
GREEN LINE EXTENSION PROJECT
MBTA CONTRACT NO. E22CN04
CAMBRIDGE/SOMERVILLE, MASSACHUSETTS
UNION SQUARE STATION
SITE PLAN

STV 100 Years		massDOT Massachusetts Department of Transportation		GLX CONSTRUCTORS	
SCALE: AS NOTED	DRAWN BY	DESIGN BY	CHECK BY	PLAN NO.	ISSUE
DATE: SEPT 28, 2017	YQT	YQT	MWR	SHEET: STA-025	0
ISSUE	DATE	DESCRIPTION	BY	CHKD	APP.

PROJECT: 06/14/17 10:51 AM BY: TANCY
 DRAWING: I:\PROPOSALS\2017\062820 0002 GLX GREEN LINE STATIONS\UNION SQUARE STATION STA - 025 - JSS.DWG [SITE PLAN] 09/

KEYNOTES

- 10 - PLATFORM
- 11 - CUSTOMER ASSISTANCE AREA & BENCH
- 12 - SHELTER
- 14 - TACTILE EDGE
- 15 - OFFICIALS BOOTH
- 16 - EMERGENCY EGRESS SLOPED WALK
- 17 - EMERGENCY EGRESS GATE & GUARDRAIL
- 20 - SIGNAGE MAP ASSEMBLY
- 36 - LIGHT POLE
- 40 - WASTE RECEPTACLES
- 41 - SALT STORAGE BIN
- 42 - SAND STORAGE BIN
- 43 - STARTER'S BOOTH @ (UNION & COLLEGE STATION)
- 44 - VARIABLE MESSAGE SIGNS (VMS)

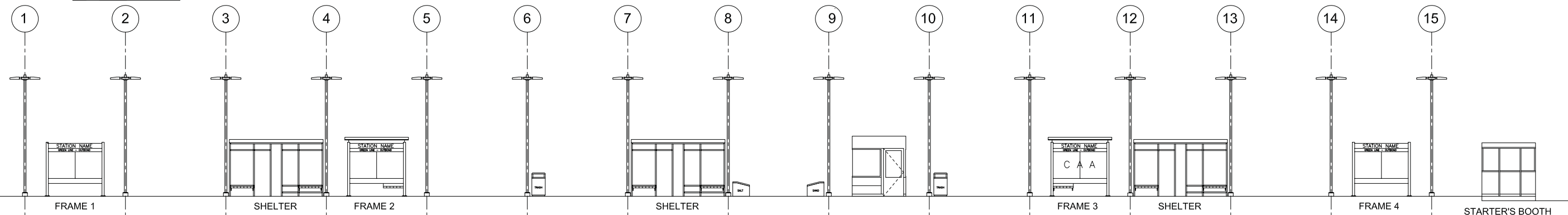
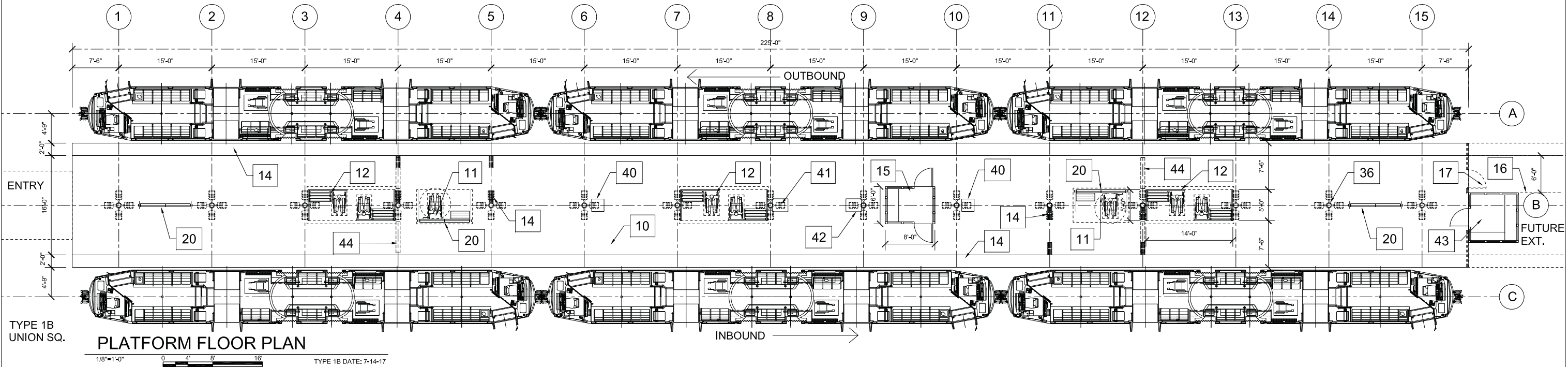
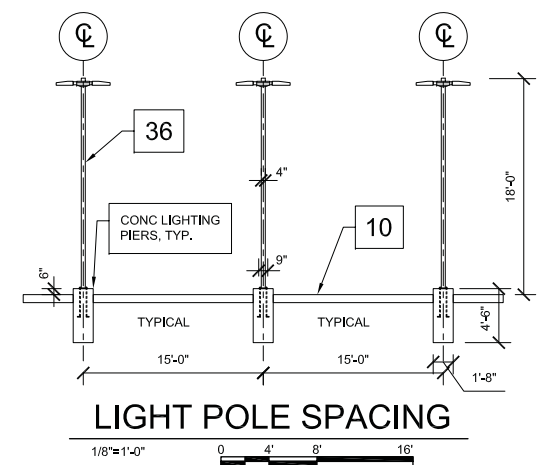
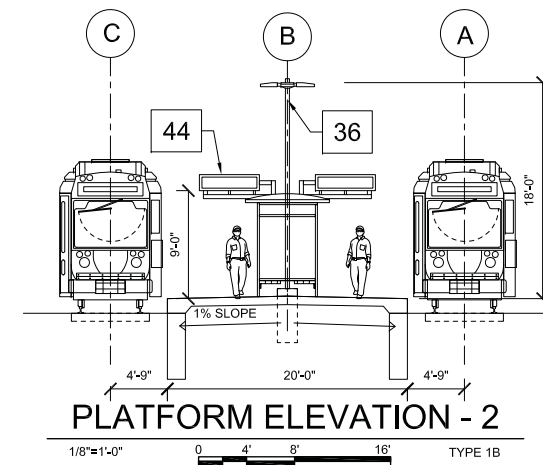

PLATFORM ELEVATION - 1
1/8"=1'-0" TYPE 1B DATE: 7-14-17

PLATFORM TYPE 1B - UNION SQUARE - 20'-0" WIDE PLATFORM

PROPOSAL

MASSACHUSETTS BAY TRANSPORTATION AUTHORITY

GREEN LINE EXTENSION PROJECT
MBTA CONTRACT NO. E22CN04
CAMBRIDGE/SOMERVILLE, MASSACHUSETTS

**UNION SQUARE STATION
STATION PLATFORM AT GRADE
ELEVATION AND SECTION**

GV20170258-273.pdf

SCALE: AS NOTED DRAWN BY: DESIGN BY: CHECK BY: PLAN NO. ISSUE

DATE: SEPT. 28, 2017 PDS PDS SHEET: STA-026

4.4 LANDSCAPING AND STATION SIGNAGE DESIGN

The Green Line alignment landscaping is an outward expression of the MBTA's desire to enhance the public's perception toward the Project. Conforming to the requirements of the Technical Provisions, the landscaping softens the hardscapes of the Project and improves rider experience. Although the opportunity for landscaping within an urban area is limited, GLX Constructors has complemented the historic greater Boston area by assimilating the taste of the community path walkers and transit riders to the favorable, durable landscaping aesthetics.

The landscape architecture component for the Project involves preparing plans that address the site-specific needs of each station, Traction Power Sub Station, and Pump Stations. Attractive and viable plants will be designed for the stations to help mark access points, stabilize steep slopes, restore disturbed areas, and screen off station buildings. We will coordinate with third party developers to integrate the station plantings with adjacent developments. All landscaping will be designed to visually complement surrounding areas.

4.4.A LANDSCAPE ARCHITECTURE

Approach and Site Specific Designs Conformance to Landscape Requirements

One of our first tasks will be to conduct a Planting Inventory Survey to identify the existing vegetation, evaluate the condition of the plants, and determine how to best manage and/or protect these plantings. We will also complete a Tree Protection and Maintenance Plan to identify trees on abutting properties that need to be protected and cared for throughout the construction process. As required in all transportation corridor settings, the plantings will be durable, will not reduce sightlines for any mode of transportation, will not compromise the sightlines of surveillance cameras or security lighting, and will not create a nuisance of any kind.

Plantings will be installed per the Technical Provisions, to include:

- ▶ Providing minimum topsoil depths of 6 inches for seeded areas, 18 inches for shrub plantings, and 36 inches for tree plantings
- ▶ Mulching shrub and tree planting beds
- ▶ Providing tree pits that are three times the rootball diameter
- ▶ Installing salt tolerant plants resistant to snow stockpiling
- ▶ Locating snow stockpiling areas for each site.

In accordance with the MBTA's design review process, the landscape architecture plans will be shared with GLX Constructors and the MBTA for review and comment, and revisions made accordingly.

Site-Specific Landscaping Requirements

Stations. Each Green Line Station will be individually evaluated site-specific landscape architecture. For example, the East Somerville, Gilman Square, Ball Square, and College Avenue Stations will require stabilizing steep slopes, marking access points, and selecting and placing appropriate vegetative screening. The planting design process for the historic Lechmere, Gilman Square, and Ball Square Stations will allow for the required Memorandum of Agreement (MOA) design review. In the case of Union Station, the coordination with third-party developers will be required to integrate the MBTA's station planting approach with the developers' adjacent properties.

▶ **Lechmere Station.** We will fulfill two third-party agreements describing the tree replacements east of the historic viaduct.

▶ **East Somerville Station.** Requires stabilizing a steep slope between the corridor rail fence and Washington Street Pump Station. This includes furnishing 12 inches of planting medium, drought-tolerant erosion control seed mix, and slope stabilization fabric.

▶ **Union Square Station.** We will coordinate the work and phasing activities with the third-party developer for the surrounding areas.

▶ **Magoun Station.** Located in an urban environment and built on a structure that will not support plants. So there are no landscape architectural plans for Magoun Station. However, GLX Constructors will complement the station design with as much greenery over the hardscape as site conditions will allow.

▶ **Gilman Square Station (Historic).** We will screen the Traction Power Sub Station with trees and shrubs as shown in Figure 4.4-2. We will also provide 6 inches of planting medium and drought-tolerant erosion control/restoration mix with slope stabilization fabric at disturbed areas between corridor fence, the retaining wall/community access path, and above the retaining wall on the existing steep hillside.

▶ **Ball Square Station.** The work at Ball Square Station consists of shrub and grass plantings to mark the station entrance and the stabilization of an adjacent steep slope off of the Broadway Street Bridge. In the course of this work, we will provide 6 inches of planting medium and drought tolerant erosion control/restoration mix installed with slope stabilization fabric.

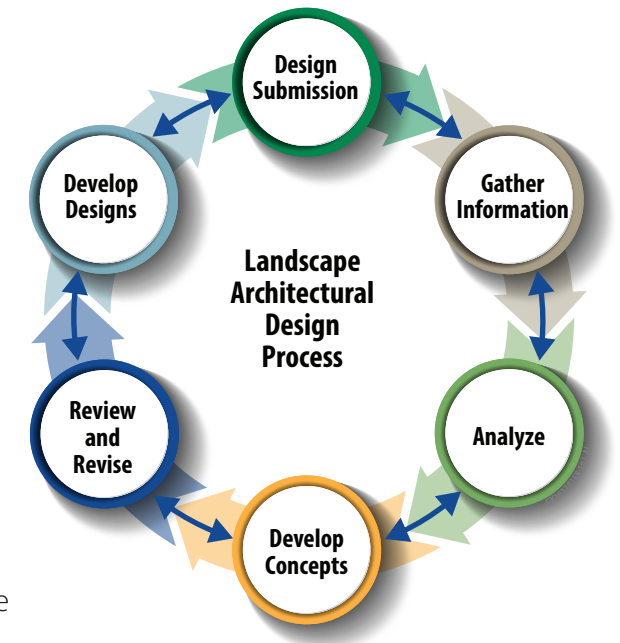

Figure 4.4-1. Landscape Architectural Design Process. GLX Constructors' Creative Process to Developing the Landscape's Architectural Design.

“ We will test and review soils, and proposed plantings will be selected to be low-maintenance, native, and drought-tolerant species that will grow in typical Northeast United States weather conditions.

► **College Avenue Station.** We will incorporate plants at the station entrance as shown in the Project Definition Plans and in Figure 4.4-3. Which specify installing deciduous flowering trees, 13-15 feet in height, placed no closer than 10 feet from the corridor fence, shrubs 24-36 inches in height, spaced at 30-36 inches on center, woody groundcover, and perennial plantings spaced at 18 inches on center with mulch provided for all planting beds.

We will also stabilize the sloped area above the proposed retaining wall and the Boston Avenue sidewalk extending the length of the retaining wall. We will do this by installing 6 inches of planting medium, drought-tolerant erosion control/restoration mix with slope stabilization fabric, and shrubs with stabilizing root systems.

Vehicle Maintenance Facility. This planting design will mark the entrance to the facility from Third Avenue and Inner Belt Road and create a natural accent to this urban industrial site, including creating a meadow for the future Transportation Building (TSP). The Inner Belt Road entrance and parking lot planting design incorporates plants as shown in the Project Definition Plans. At the future TSP site, we will install 6 inches of planting medium and drought-tolerant seed mix. The shrubs will be 24-36 inches in height and spaced at 30-36 inches on center. Woody groundcover will be provided, and perennial plantings will be spaced at 18 inches on center. The specified trees will be deciduous and chosen for their canopy shape with a minimum initial caliper of 3-3.5 inches. We will mulch all plant beds.

Traction Power Substations. The Traction Power Substations (TPSS) at Gilman Square and Ball Square will be screened with vegetation to limit the view of the power facilities. Coniferous trees with an initial height of 8-10 feet will be used, as well as a variety of other trees and shrubs, to create an effective and attractive screen. The TPSS at Gilman Square is between the station platform and Medford Street. The TPSS at Ball Square is located between the station platform and Boston Avenue.

Transit Corridor. In addition to completing the existing Planting Inventory Survey, GLX Constructors will direct the development of a Tree Protection and Maintenance Plan for abutting properties. The Planting Inventory Survey will identify existing vegetation impacted by the Project, and evaluate the condition of the plants to determine the best way to protect them. The Tree Protection and Maintenance Plan will identify trees on abutting properties that need to be protected and cared for throughout the construction process.

Planting Criteria

All plantings will be installed per the requirements as stated in the Technical Provisions. These include selecting native New England plant material that is drought tolerant, disease resistant, low maintenance, and produce no appreciable vegetative litter.

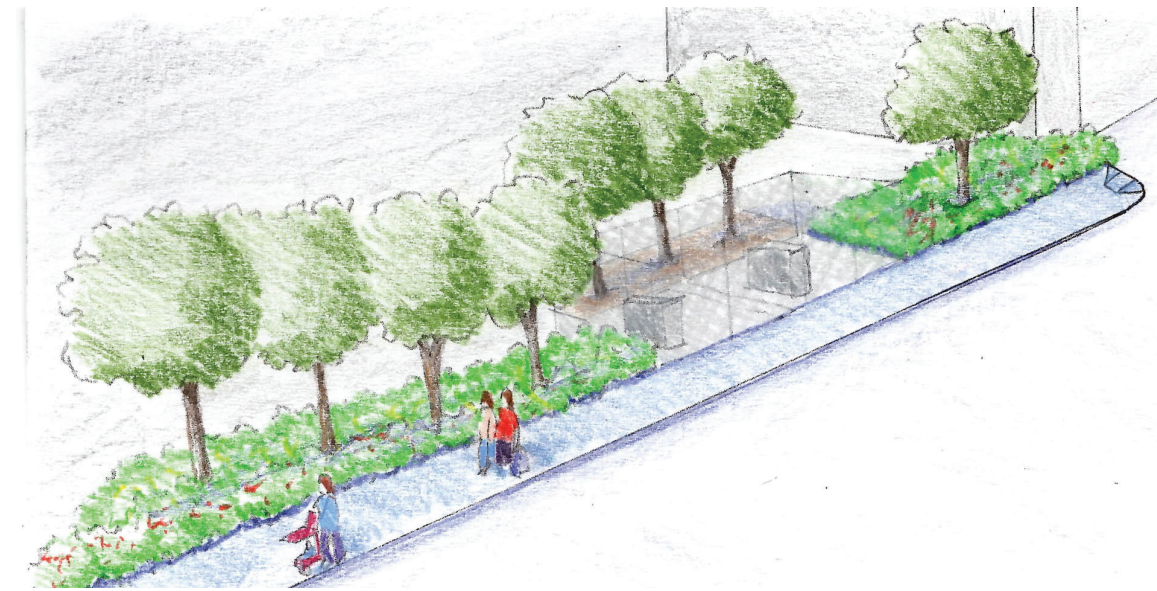

Figure 4.4-2. Streetscape on Medford Street at Gilman Square Station. Landscaping elements were included to screen the TPSS with trees/shrubs.

The plant material will conform to American Standard for Nursery Stock ANSI Z60.1 and will have a one-year planted material guarantee of watering and maintenance period, as specified in the Landscape Maintenance Plan. The street trees will conform to the municipality specifications, including compliance to pedestrian, bicycle, and vehicle passage standards. The proposed deciduous trees will have a minimum caliper of 3-3.5 inches and the evergreen trees will be a minimum height of 8-10 feet. These trees will be selected to minimize leaf litter on the tracks, will be located a minimum of 10 feet from the ROW fence, and will avoid conflict with any utilities. All plants and seed mixes will be suitable for Zone 5 planting zone.

We will obtain and review soil tests of stockpiled or base loam intended for planting medium, an analysis of proposed amendments such as compost, other organics and/or sand, and an analysis of proposed ratios of all planting medium components or blended planting mediums. Submittals will also include verification of subgrade compaction prior to placing planting medium, and the procurement, placement method, and management of placing the planting medium.

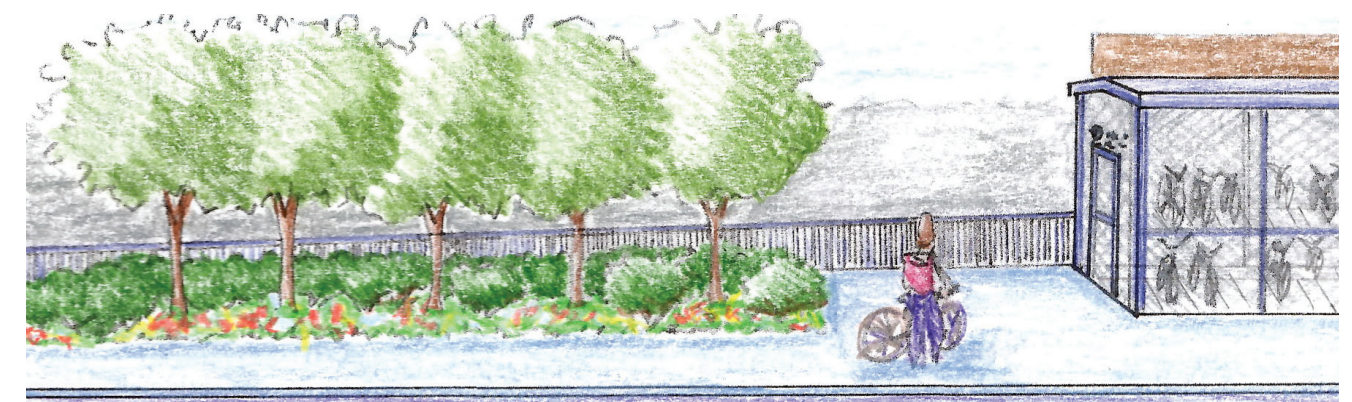

Figure 4.4-3. College Station Entrance Plaza and Bicycle Storage Facility.

Site Amenities and Furnishings

At the Community Path, we will identify and specify the type and location of bench, trash, and recycling receptacles to be installed. These selections will comply with the City of Somerville's to best integrate this new path with the existing multi-use path system. This work will be designed and completed as specified in the Technical Provisions, including placing furnishing at every 1,000 feet and at each side of roadway intersections. The benches, trash, and recycling receptacles will be placed on concrete slabs. Trash and recycling receptacles will be placed on each side of the street at each at-grade street crossing of the Community Path.

Third Party Agreement Requirements

A Third-Party Agreement pertaining to vegetation requirements calls out the replacement of all trees to the east of the Lechmere viaduct at 7-13 East Street, 1 Leighton Street, and 1-5 East Street in Cambridge. An additional Third Party Agreement for 360 Medford Street, Somerville, specifies that nine new trees meeting the City of Somerville standards will be installed at that site. Careful consideration will be given to the type and size of the existing trees to be replaced in Cambridge, and to the tree types that flourish in Somerville, such as planting new trees in a pit that is three times the width of the new tree's rootball. All trees will be installed as specified in the Technical Provisions.

Landscape Drawings for Stations

Renderings for Typical Grading, Materials, Site Amenities, and Furnishings



Figure 4.4-4. View of Third Avenue Entrance to Vehicle Maintenance Facility.
Typical grading, materials, site amenities for the Third Avenue Entrance to the VMF.

4.4.B WAYFINDING, SIGNAGE, AND VISUAL DISPLAY

Overall Visual Elements Strategy

Because there are three different types of stations along the alignment, each station type requires a different visual element strategy. Visual elements will be developed based on each station type's characteristics, which are detailed in Figure 4.4-5.

Elevated	Depressed	On-Grade
Lechmere	Gilman, Magoun, and College	Union, East Somerville, and Ball
<ul style="list-style-type: none"> ▶ Station entrance is on grade under viaduct with elevators and stairs up to center platform. ▶ Two entrances, one at each end of the platform, which also serve as exits. ▶ Intermodal station with bus loop and RIDE stop. 	<ul style="list-style-type: none"> ▶ Station entrance is on grade under viaduct with elevators and stairs up to center platform. ▶ Two entrances, one at each end of the platform, which also serve as exits. ▶ Intermodal station with bus loop and RIDE stop. 	<ul style="list-style-type: none"> ▶ Station entrance is at track level between end of tracks at Union, and at track level requiring and on grade track crossing at East Somerville and Ball. ▶ There is one entrance, and an exit used only in emergencies. ▶ Union is intermodal with RIDE stop.

Figure 4.4-5. Station Types along the Alignment. The overall visual elements strategy will be based on the specifications of each station.

Approach to Placement and System Integration of Signage and Common Elements

The station signage components are the common denominator of the MBTA's system-wide visual elements strategy. Signs act to confirm intuitive wayfinding, and to distinguish between accessible and non-accessible wayfinding when they are not in parallel. They also set precedent for scale, color, materials, and detailing when interfacing with the MBTA's customers. Moreover, they comprise a tried-and-true system, are modern, and have proven themselves adaptable to new technologies introduced over time.

The Green Line Extension's alignment and the distribution of stations along its corridor, located at accessible points, have resulted in several different configurations of stations.

While the exact nature of the access to the platform varies, each station's presence is pronounced by one or more MBTA or lollipop signs as shown in Figure 4.4-6 at the sidewalk or Community Path. Each has an associated bicycle storage facility and an entrance properly defined by the entrance sign bearing the station's name at the roll up security grille, a street/lobby sign informing incoming passengers of their inbound, outbound and system-wide options, and the platform signs, which dictate the design of the platform.

These elements are complemented by track signs bearing the name of the inbound and outbound destination and the "Emergency Exit Only" sign, which clearly demarcates the end of the platform and the public realm.

At Lechmere Station, the entrance/exit sign and security grille are incorporated into the fence capturing both the bottom of the stair and elevator. These are adjacent to one another and the elevator is signed. The street/lobby sign displaying the rapid transit and green line maps are also located on the secure side with the fare machines and associated benches.

While there is ample space for queuing at the machines, it is evident that this is a dedicated circulation route leading to one destination only—the platform. Vertical circulation is parallel and the top of the stair meets up again with the platform elevator stop, also signed. Arrival at the platform is confirmed by another entrance sign, stating “GREEN LINE – ALL TRAINS.” The platform side of which indicates that the main entrance is also an exit.

Each side of the platform includes track signs stating the destination of the train and length of wait predicted by the variable message signs as shown in Figure 4.4-7. The inbound and outbound directions of the tracks determine the sequence of information provided on either side of the platform, which is set by associating a Customer Assistance Area with the lead train. The platforms influence the location of all the other elements on the platform, including the shelters.

Boarding passengers will see a repetition of the rapid transit line map and either a green line inbound or outbound map. Neighborhood maps are provided for disembarking passengers, which they will encounter again as they exit past the street/lobby sign at the station entrance. The emergency egress at the inbound end of the platform opposite the entrance is also signed.



Figure 4.4-6. Bike Storage Facility. Example of typical signage and space provided to dismount and stow bicycles in the storage facility.



Figure 4.4-7. Variable Message Signs at Platform at Ball Square Station.

Approach to Provide Intuitive Wayfinding

At East Somerville Station, which is one of the three on-grade stations, there are two T signs, both of which will be encountered entering from Washington Street onto the Lower Community Path where the first is located. The second is located at the landing between the Lower and Upper Community Paths, and it is the only one encountered when inbound on the path. Given the distance of the station platform off the street, it is necessary to provide signage at both points; both an entrance sign and a street/lobby sign are proposed in each location.

Regrading the Lower Community Path, within the definition of a sloped walkway, to shift the landing from opposite the inbound end of the platform to opposite the outbound end of the platform separates the actual station entrance from the bicycles through traffic on the path.

The dedicated entrance walkway from the landing parallels the station platform, which provides full visibility from one side to the other across the inbound track and ROW fence. However, it also provides adequate space to dismount and stow a bicycle in the storage facility without interfering with pedestrians entering the station. At this point, the ROW fence is an obvious location for a transparent, linear art piece. The station entrance, consisting of a roll up security grille carrying the station entrance sign, is fully visible from the Upper Community Path and the landing. To limit time spent in the ROW, the station entrance is purposely located close to the track crossing at the entrance end of the platform, where the fare vending machines are located.

Approach to Accessible and Non-Accessible Wayfinding Routing

At Gilman Square Station, located between the Medford Street and School Street bridges, the access to the center platform is from the Community Path. The elevated path and station-side entrance bridge remove the need for a track crossing, providing system-wide benefits. In addition to a staircase, an elevator to the platform provides universal access. The elevator and stairs are both pass-through, and allow users an uninterrupted path from bridge to top of elevator or stairs, down either, then enter directly on to the platform below.

This configuration also allows for a physical expression that is interesting, especially because both the entrance bridge and platform are exposed to the public realm, and the connecting stair and elevator elements are transparent. The architectural language originates with the signage and associated furnishings, which drive the platform design such that the platform itself becomes an element, and which extend out past the station entrance and are visible to the surrounding community. Figure 4.4-8 Shows the Gilman Square Station bike storage facility.

At both the Medford and School Street ends of this segment of the Community Path, there will be a T sign announcing the presence of the station. The station entrance will be defined by the overhead GILMAN STATION sign. The bike storage facility opposite it will carry its own signage, and allow for the street/lobby sign. The fare vending machines and associated benches are immediately inside the entrance and are again available at the elevator. Properly sized and located, these elements combine to form a cohesive whole that is recognized as a station belonging to the Green Line. The sequence is familiar and predictable, offering immediate feedback and assurance to someone in unfamiliar territory that they are on the right track.

The landscape and station signage design for the Project will provide an aesthetically positive environment. The greenery, plants, and signage will alleviate the harshness of the large, urban facility by screening some of the more industrial transit components – all while providing key indicators for the traveling paths. These designs will contribute to the safety of the corridor as they clearly define the designated pedestrian areas and welcome riders to the Green Line.



Figure 4.4-8. Gilman Station Bike Storage Facility. Stations and associated facilities have identifiable elements and signage to form a cohesive and recognizable design.

ITP Request	RFP		
	Drawing Number	Drawing Title	Reference Section or Drawing
A5.2.4.A.2			Landscaping drawings are represented by the graphics and renderings provided with the section narrative.
A5.2.4.A.3			Landscaping drawings are represented by the graphics and renderings provided with the section narrative.
A5.2.4.B.2	LS-001	Ball Square Station Site Plan - Static and Variable Message Signage	
	LS-002	Ball Square Station Static and Variable Message Signage @ Station Platform	
A5.2.4.B.3			Landscaping drawings are represented by the graphics and renderings provided with the section narrative.

Technical Solutions Drawing Matrix.



EYE VIEW OF BICYCLE ENCLOSURE LOOKING EASTWARD



EYE VIEW AT STATION ENTRANCE



ACTIVE WAYFINDING SIGNAGE AT STATION PLATFORM



PASSIVE WAYFINDING SIGNAGE AT STATION PLATFORM

PLOTTED: 08/25/17 4:19PM BY: DESMCP
 DRAWING: C:\USERS\DESMCP\AppData\Local\Microsoft\Windows\Temporary Internet Files\Content.Outlook\3RAXKUP\PROPOSAL_BORDER.DWG [MODE] 08/1

PROPOSAL

T	MASSACHUSETTS BAY TRANSPORTATION AUTHORITY
	GREEN LINE EXTENSION PROJECT MBTA CONTRACT NO. E22CN04 CAMBRIDGE/SOMERVILLE, MASSACHUSETTS

**BALL SQUARE STATION SITE PLAN
STATIC AND VARIABLE MESSAGE SIGNAGE**

						GV20170258-274.pdf									
SCALE: N.T.S.	DRAWN BY: PDS	DESIGN BY: PDS	CHECK BY: ND	PLAN NO.	ISSUE										
DATE: SEPT. 28, 2017				SHEET: LS-001	<table border="1" style="width: 100%;"> <tr> <td style="width: 25%;">ISSUE</td> <td style="width: 25%;">DATE</td> <td style="width: 25%;">DESCRIPTION</td> <td style="width: 25%;">BY</td> </tr> <tr> <td> </td> <td> </td> <td> </td> <td> </td> </tr> </table>			ISSUE	DATE	DESCRIPTION	BY				
ISSUE	DATE	DESCRIPTION	BY												



AERIAL VIEW FROM BROADWAY EASTWARD



AERIAL VIEW FROM BOSTON AVE NORTHWARD



EYE VIEW FROM BOSTON AVE LOOKING EAST



EYE VIEW FROM BROADWAY LOOKING WEST

PLOTTED: 08/25/17 4:17PM BY: DESMCP
 DRAWING: C:\USERS\DESMCP\AppData\Local\Microsoft\Windows\Temporary Internet Files\Content.Outlook\3RANXGUP\PROPOSAL_BORDER.DWG [MODEL] 08/1

PROPOSAL

T	MASSACHUSETTS BAY TRANSPORTATION AUTHORITY
	GREEN LINE EXTENSION PROJECT MBTA CONTRACT NO. E22CN04 CAMBRIDGE/SOMERVILLE, MASSACHUSETTS

BALL SQUARE STATION STATIC AND VARIABLE MESSAGE SIGNAGE @ STATION PLATFORM

						GV20170258-274.pdf	
SCALE: N.T.S.	DRAWN BY: PDS	DESIGN BY: PDS	CHECK BY: ND	PLAN NO.	ISSUE		
DATE: SEPT. 28, 2017	DATE: SEPT. 28, 2017	DATE: SEPT. 28, 2017	DATE: SEPT. 28, 2017	SHEET: LS-002	ISSUE		
ISSUE	DATE	DESCRIPTION	BY	CHK'D	APP.		

4.5 VEHICLE MAINTENANCE FACILITY

Green Line commuters expect that their daily commute take place in a safe, clean, and reliable vehicle. It is imperative that Light Rail Vehicles (LRV) are serviced daily at the Vehicle Maintenance Facility (VMF) to meeting operational needs. Similarly, a carefully programmed Transportation Building is important to support the operations at the VMF, LRV storage track yard, and revenue service along the ROW. Reliable Green Line operations will be delivered by a durable VMF and Transportation Building that are designed and built to perform for decades to come.

Our Lead Designer, STV, has worked with the MBTA the Orange Line Carhouse Project, which recently broke ground in July 2017. Based on STV's MBTA knowledge and GLX Constructors' experience delivering similar infrastructure facilities nation-wide, our team will provide constructible designs that meet the expectations of MBTA earlier and deliver the Project on schedule.

4.5.A ARCHITECTURAL DESIGN

Twentieth century architect Louis Sullivan, the inventor of the modern high rise, coined the phrase "form follows function." We have conceived a design where the form is functional and provides a safe, durable, and accessible working environment for the MBTA's maintenance personnel. The same is true with the Transportation Building. This facility has been designed to provide a pleasant and inviting working environment as well as a productive and efficient space for the MBTA Operations personnel to execute their daily operations.

Approach to Meeting the Architectural Requirements

The architectural elements of the VMF are designed to be compatible with the existing Green Line No. 7 and 8 cars that feature high-level seating, with much of the equipment being mounted below floor as well as the newer Type 9 cars that feature low-level floors and most of the vehicle equipment maintenance will focus on the rooftop of the vehicles. Shop pits are designed to accommodate maintenance functions while also addressing the need for maintenance of roof-mounted equipment. Heavy equipment will need to be removed from beneath the vehicle on all vehicle types by in-floor rotating lifts. Adequate access for forklifts to the vehicle sides at pit level has been provided.

There are three standard considerations that must be accounted for when designing shop facilities: ergonomics and safety, durability and maintainability. Materials should be selected that match the operator's existing facilities to simplify maintenance and new materials should be considered if those materials can demonstrate significant improvements in life-cycle cost.

When considering the maintenance and repair of rail vehicles, a facility must allow for efficient work flow and minimize day-to-day service and operations disruptions. Consumable and spare part housing should be located close to where they will be used or installed. The proper tools should be located at or near that location as well. For example, if an overhead crane is needed to replace

roof-mounted HVAC unit, that crane can access the HVAC nearby storage area much more quickly than a storage area that is far away.

Similar considerations must be given to undercar components. Maintenance and service of the equipment require pit access from underneath or the side of the car and the replacement of these larger components and is more easily performed on a flat surface with track and body hoists, portable lift tables, and forklifts.

Life Safety Codes and Relevant Applicable Standards, Addressing Workplace Safety.

Life and work place safety considerations are paramount when designing industrial facilities like the VMF. The design has considered the DC traction power electrification system that will require increased safety measures from operations personnel. Employees will be working on the top, underneath and all around LRVs while near adjacent tracks where LRVs are entering and exiting the building. Fork lift safety and awareness is also important due to the movement of parts and materials throughout the building. Fail safe measures and countermeasures will be required to make certain the traction power system is denergized when an LRV is being worked on and vice versa when the system is reenergized. This will be accomplished through interlocking, visual, audible devices, and strategically-placed signage.

At the outset, GLX Constructors will meet with the MBTA to validate the VMF space program and confirm a full understanding of the how the MBTA envisions the VMF's operation and function. This alignment will set the Standard Operating Procedures (SOP) for the facility. The SOP's as our baseline, we will evaluate the facility as a whole for life and work place safety. We will drill down to activities in the individual shop areas and how they will interface with their adjacencies and employee safety measures. This SOP alignment process will also be employed for the Transportation Building.

Control of stray current will be handled and addressed as another important component considered as it relates to workers safety in the VMF and yard areas surrounding the Transportation Building.

Other considerations for life and work place safety include but are not limited to:

► **Appropriate Separation of Work Tasks.** Good design creates both geometric separation and, in many cases, physical separation between the numerous workplace activities. This applies to the obvious separation of office and administrative staff from maintenance operations, but also to the separation of technicians doing bench work on electronics and other small assemblies. Proper design separates these activities either by distance, acoustic treatments, or both.

► **Adequate Sight Lines.** Designs will focus on increasing sight lines to promote worker awareness of other activities in their area and adjacent areas. The greater the sight lines, the more time a worker has to react to a potentially hazardous situation.

▶ **Adequate Lighting.** Lighting must be designed to provide enough lighting without creating high levels of contrast or glare. Taking advantage of Somerville's climate and sun angles, the introduction of daylighting throughout the facility can support a safe work environment

▶ **Adequate Work Clearances.** Adequate space must be provided for safe workplace activities. Designing adequate clearances will require to planning for fall protection, if required by the MBTA. Clearances must take into account the clearance envelope required for rooftop mounted systems and their enclosures. This issue has been a major factor in the design of vehicle lifts, bridge cranes, and the OCS system along Tracks 1 and 2 of the VMF.

Sections 13.1 and 13.4 of the Technical Provisions state the codes and standards that should be used and followed in the design of the VMF and Transportation Building. These include 780CMR MA State Building Code, 521CMR Architectural Access Board, and the MBTA Guidelines & Standards and Guide to Access. Life safety codes such as NFPA 13 – fire protection and NFPA-72 fire alarm as well as applicable OSHA regulations will be considered in the design of these buildings.

Net and Gross Floor Area Summary for all VMF Facilities. The total area of the VMF is approximately 54,000 G.S.F. which is in line with the Volume 2 Project Definition Plans. We have enhanced the column grid lines to eliminate conflicts between maintenance equipment, working envelopes, accessibility, and overall flow throughout the VMF. The overall floorplate, interior rooms and the space program remains as is and depicted in the Volume 2 Project Definition Plans and outlined in Section 13.1 of the Technical Provisions. The net square footage will be established when:

- ▶ The overall program is validated with the MBTA
- ▶ An in-depth and detailed code summary and analysis has been performed to identify all occupancy uses within the building
- ▶ The details of wall assemblies, such as required for fire separation, have been developed and established

Section 13.4 of the Technical Provisions calls for the Transportation Building to be approximately 1,425 square feet. The overall floorplate, interior rooms, and the space program remains as depicted in the Volume 2 Project Definition Plans.

An Architectural Design Description of All Buildings within the VMF Site.

There are two buildings within the VMF site perimeter and boundaries, the VMF itself and the Transportation Building.

▶ **Transportation Building.** The Transportation Building is a one-story building approximately 24'x 60'. The exterior wall assemblies and roof assemblies will be specified to meet all applicable energy codes and the requirements and criteria set forth under Volume 2 Technical Provisions, Section 13.4 including

passing NFPA 285. The building will also have interior partitions/walls as shown on the Volume 2 Project Definition Plans, Exhibit 2B; Dwg. TSP-A-1000 along with two sets of ramps and stairs, one set on either side of the building. The length of the ramps and rise/runs will be based on the height of the finished floor above finished grade. Our proposed design intends to support the building on a series of spread footings and raised pedestals foundations to avoid having the building floor system be in contact with the ground. Otherwise a gas vapor barrier system will have to be employed beneath the concrete floor slab based on the environmental Activities Use Limitations (AUL) currently in place in this area of the VMF site.

▶ **Vehicle Maintenance Facility.** The VMF is a one story building approximately 162'x 333' which matches the overall dimensions as shown on the Volume 2 Project Definition Plans, Exhibit 2B; Dwg. MAF-A-1100. The architectural and structural floor plans, framing plans, Exterior Building elevations, Building cross sections and typical wall sections are included at the end of this section. These plans/drawings are based on these dimensions and in accordance with the space program requirements and room criteria requirements and criteria set forth under Volume 2 Technical Provisions, Sections 13.1, 13.2 and 13.3. We believe the drawings best describe the overall architectural description for this buildings, however, some key architectural items include but are not limited to the following:

- ◆ Exterior wall assemblies of the typical wall sections will pass NFPA 285.
- ◆ The various roof heights were set based on the space program set forth in Section 13.1. Note the highest roof level is governed by the 10-ton bridge crane servicing the area over Tracks 3 and 4.

Narrative Describing How the VMF will Accommodate Specific MBTA Requirements.

GLX Constructors will meet with the MBTA to confirm a full understanding of the maintenance program and requirements. Based on this alignment, we will configure the shop to reliably perform these functions and fully support MBTA's daily car count requirement.

Narrative Describing the Quality of Physical Working Environment.

We will design the VMF to provide a safe and functional working environment. Travel paths for vehicles, materials, and workers will be carefully planned and laid out with appropriate floor striping. Proper signage in strategic locations and key decisions points will provide clear and safe travel pathways through work zones.

Clear lines of sight, aisle widths, and clearances will be provided in conjunction with code-required egress. These safety features will also apply to the exterior building.

We will ergonomically design the VMF to be easily maintained, which will allow maintenance and cleaning staff to safely perform their work. Materials and finishes selected for walls and floors will be durable, slip resistant, and easily

cleaned. In addition, material surfaces will minimize reflection to reduce glare. Light fixtures and lamps will not alter color rendition and lighting intensity will be designated to match the specific function of the space.

Integration of Key Systems. The overhead door system at each end of the VMF for tracks will operate and be interfaced with the OCS to insure a smooth transitioning of the LRVs from the yard into and out of the building.

A detailed description of how GLX Constructors envisions the OSC system will need to integrate, interface, interlock, and operate in unison with, on its own, and with other systems is provided further on in this Section.

Integration of Structures. The VMF's structure maximizes function and productivity in two ways:

1. We have deleted the longitudinal column line between Tracks 1 and 2 to optimize the inspection area work space for equipment and personnel.
2. Three lateral column lines have been deleted and remaining column lines repositioned to optimize transverse movements of personnel and equipment through the building. This provided substantial space improvement between Tracks 3 and 4 and the maintenance and storage areas.

Integration of Equipment. Integration of equipment related to building support systems and maintenance equipment have been considered. Structural support of large roof top HVAC will be provided to utilize the superstructure of the building while optimizing the distribution of ductwork. The ductwork will be routed to avoid moving bridge cranes and the OCS system. Ductwork will be routed vertically down to the pit levels where it will not be damaged by moving equipment or encroach on personnel work spaces.

Large pieces of maintenance equipment such as the vehicle lifts, bridge cranes, and truck washing equipment will be procured early in the Project to set pit dimensions, access points, and working envelopes. This will enable our team to the foundation design and make any necessary adjustments to building heights.

Integration of Materials. Isolation of dissimilar materials and separation of various systems will be as important as compatibility of materials because of the DC traction power in the building. Stray current considerations within the building for architectural and structural components will be incorporated as a passive or induction system or both. Special coating might also be required in some instances to combat and restrain stray current. A continuous nonconductive (i.e. fiber glass panel system) will need to be placed between the OCS wires over Tracks 1 and 2 and the underside of the building's steel superstructure framing and roof assembly to insure any arcing does not migrate to the aforementioned building components. Paints, sealants, and coating systems will be compatible with materials they are being applied to and also the environment they will perform in. GLX Constructors will plan and design the materials in compliance with the criteria set forth in the RFP.

A Discussion of How Accessibility will be addressed at the VMF.

Specific codes will play an important roles in establishing accessibility inside and outside the building, including the following:

- ▶ 521 CMR
- ▶ OSHA regulations, such as OSHA Section 1910 which concerns ladders, stairs and passageways in and around equipment and pit access.

Fully addressing accessibility requires a detailed Code Summary review for the entire building. The Code Summary review will set the building's occupancy use and lead to identifying path of travel limitations, routing, egress points, fire separation, fire protection coverage, and many other potential requirements.

Our understanding of the work that will be taking place in the VMF and Transportation building, our past experience, and the previous work performed by the MBTA has allowed us to reason that building occupancy use for the VMF will likely be categorized as B, S-1, (possibility S-2) and the previously identified F-1 use groups, whereas, the Transportation Building will likely be B-use group category only.

A detailed Code Summary analysis and review will be one of the first tasks performed in the early stages of design. Once complete, GLX Constructors will arrange a meeting with the local Building Inspector to review our Code Summary and make certain we are aligned with the Inspector requirements.

Roadway access to and from the site and around the buildings themselves will be important for personnel, service vendors, and fire department. Emergency access will be reviewed with the City of Somerville Fire Department early on in the design process.

Approach to Achieving Durability. Our approach to achieving durability includes:

- ▶ **Maintainability.** Our Lead Designer has produced designs that require less maintenance because they are functionally adaptable and constructed from materials that are appropriate for their application. This is evident in the recently completed renovation design of the MBTA Orange Line Carhouse, which included a combination of precast concrete panels and metal wall panel system for the exterior building wall envelope.
- ▶ **Design for Natural and Industrial Environmental Conditions.** Materials will be specified that are suitable in the industrial environment for both the VMF and Transportation buildings. We recognize how the natural environment affects materials and their sustainability over significant life cycle periods. Materials will be specified for zero maintenance whenever possible.



MBTA Orient Heights Blue Line Car House. A similar door system will be used at the VMF to accommodate the OCS.

▶ **Select Materials for Durability.** Our design will select materials that minimize maintenance over their life cycle while meeting performance criteria.

▶ **Abuse and Stain Resistant Materials in Heavy-Use Areas.** We will incorporate materials that can withstand abuse and maintain the intended finish. Materials will be chosen to be compatible with the broad range of lubricants, solvents, and heavy wash use in areas such as loading docks, truck wash, and other areas where abusive environmental conditions are prevalent.

Description of the Noise and Vibration Impact Mitigation. Noise and vibration generating equipment such as air compressors, pumps, and vehicle lifts will be acoustically isolated from office spaces in the building. The HVAC mechanical equipment will be located away from office spaces and vibration isolated. To reduce vibration transmission from HVAC units, vibration-isolation systems will be incorporated. Interior partitions, such as walls, floors, and ceilings, will be designed to reduce the transmission of noise to other parts of the building. The noise reducing partitions will meet an STC class of 45 or greater.

GLX Constructors will address exterior noise and vibration with the VMF and yard design to be compliant with the mitigation requirements of the Project. Noise and vibration sources at the facility will include:

- ▶ Noise from the maintenance facility building
- ▶ Auxiliary equipment from GLX cars idling in the yard
- ▶ Car movements entering and leaving the yard
- ▶ Potential wheel squeal from tight radius curves in the yard
- ▶ Impact noise and vibration from special track work and turnouts in the yard
- ▶ Noise from the maintenance facility parking lot

The contributions from these sources will be combined with the projected levels from Green Line operations to project total future noise and vibration at nearby sensitive locations. Noise mitigation will be provided for moderate noise impacts when the existing day-night average noise levels (Ldn) exceed 65 dBA (exterior). We will mitigate noise for impacts with no significant outdoor land use if the interior Ldn is above 45 dBA from GLX Project sources, or if single-event maximum noise levels (Lmax) are projected to be above 65 dBA (interior). Noise impact and mitigation locations will be confirmed during final design.

Ground-borne vibration from Green Line trains will be below the applicable impact criteria. Vibration mitigation will be included where necessary to meet the project vibration criteria.

Light Trespass Mitigation Techniques. All fixtures located on the property will be dark-skies compliant – full cutoff fixtures that limit the intensity of light in the 80 to 90 degree region of the fixture. In addition, shielding will be used where light spill to adjacent properties is of particular concern.

Architectural Drawings

Architectural drawings for the VMF are included at the end of this section.

4.5.B MECHANICAL, ELECTRICAL, AND PLANT

GLX Constructors will select electrical and mechanical systems based on best engineering practices, MBTA requirements, code compliance, energy efficiency, ease of maintenance. GLX Constructors will use their experience on transportation maintenance facilities in selecting equipment and making design decisions while adhering to the criteria and requirements outlined under the RFP Technical Provisions and Project Definition Plans.

General Design Approach to Electrical Systems, including Redundancy and Emergency Power and Equipment Selection.

GLX Constructors will work with the MBTA to define all of the required power and lighting needs, and to develop an electrical design for the VMF that allows performance of the day-to-day functions. The following systems will take into account the rugged environment of the VMF and its intended longevity.

▶ **Redundancy.** Redundant power feeds are not required for the VMF. The VMF will be fed from one utility feed with a generator back up (to portions of the building) and an uninterruptible power supply for life safety loads, as will the Transportation Building.

▶ **Emergency Power.** The VMF will have generator back-up power supplied from a natural gas 200kW generator through an automatic transfer switch. From downstream distribution equipment, back-up power will be provided to a 277/480V, 3 phase, 4 wire 200A emergency panel and a 150A, 120/208V, 3 phase, 4 wire communications panel.

We will back up life safety loads by an uninterruptible power supply (UPS) capable of providing 90 minutes of back-up power. The UPS will be fed through a manual transfer switch (MTS). The normal side of the MTS will feed from the station distribution normal power, and it will have an emergency feed connected to a quick connection on the exterior of the building to a temporary generator if needed.

General Design Approach to Provision PA, Fire Alarm Systems, Security, and Other Required System Elements. GLX Constructors will work with the MBTA to define all of the required system elements as defined below.

▶ **PA.** Understanding the importance of clarity and proper amplification, GLX Constructors will provide a Public Address (PA) system that uses portions of the fire alarm system speakers in accordance with NFPA 72 and the City of Somerville Fire Department's requirements. The system will provide a uniformly-distributed sound level of 12db, provide interface with the Avaya phone system for paging, and meet the requirements of the Technical Provisions.



With the Technical Provisions requirements and the MBTA's standards as our foundation, our engineering expertise will complete a design that provides reliable power, lighting, and low voltage systems to the Vehicle Maintenance Facility.

► **Fire Alarm Systems.** The fire alarm system's addressable fire alarm control panel will be compatible with the MBTA's existing central monitoring system, including SCADA, Building Management System (BMS), and Direct Digital Control (DDC). The system will connect with the MBTA's Operations Control Center (OCC) and the City of Somerville Fire Department.

All devices will be placed in accordance with applicable codes, and be appropriate for the space in which they are placed. The full system will be commissioned upon construction completion.

► **Security.** Our security design is based on a high definition (HD) internet protocol, (IP) closed circuit television (CCTV) system that is integrated with an Access Control System (ACS). Providing HD and IP systems will allow MBTA to throttle the resolution of the video streams to meet security needs as threat conditions change. The IP feature will provide remote capability.

The CCTV system design will provide coverage of critical areas, such as VMF and Transportation Building entrances and exits, equipment and storage rooms with high-value contents, and the MBTA personnel work areas. The goal is to deter internal and external threats. The ACS will control and monitor access to the facility and various rooms within. The ACS can provide instant status of all doors connected to the system.

Integrated subsystems will allow the MBTA to react effectively to emergencies.

► **Other Required Systems.** The VMF and the Transportation Building require various communications systems, including but not limited to a local area network, telephone system, and maintenance/vehicle radio systems. The team will include a Synchronous Optical Network (SONET) node into the design of the VMF and Transportation Building to establish connectivity to the MBTA's Wide Area Network (WAN).

A fare-collection maintenance station will be located in the VMF. The requirements for this room and equipment will be closely coordinated with other disciplines to make certain enough workspace has been allocated for machine delivery and equipment maintenance.

► **Traction Power/OCS.** The VMF will require a 600-volt DC power system to move the Green Line vehicles in and out of the maintenance areas and to provide a source of auxiliary power for vehicle on-board systems during maintenance activities. Automatic control of the traction power system is required to protect personnel against electrical shock hazard while they are working in the maintenance areas. The traction power system in the VMF Building will consist of the following elements: DC switchboard, cable distribution system, overhead contact system (for tracks 1 and 2), trolley stinger (for Tracks 3-4), auxiliary house power plugs, emergency trip system, and gate interlock system.

The DC switchboard will receive 600 volt power from two 1,000 kcmil feeder cables that originate at Red Bridge Traction Power Substation through a main disconnect switch/contractor. Power received is then distributed out to the overhead contact system and the auxiliary house power plugs through feeder cubicles consisting of a manual disconnect switch and an electrical contractors. The DC switch board will be located in room separate from the main ac electric room.

The cable distribution system transmits power from the switch to both the overhead contact system and auxiliary house power plugs. Feeders to the OCS will be 500 kcmil cables in 3" FRE conduits run along the ceiling trusses. Feeders to the trolley stingers will consist of 2/0 AWG cables in 2" FRE conduit between switchboard and the overhead rail. Feeders to the auxiliary house power plugs will consist of 2/0 AWG cables in 2" FRE conduits run along the shortest route between the switchboard and the contractor boxes.

The overhead contact system consists of the overhead contact trolley wire and all associated hardware required to support the wire in place. Tracks 1-2 in the VMF will be provided with an OCS allowing vehicles to move in and out of the facility through the pantograph system. The contact wire will run approximately 16 feet over the center of track and will be provided with an insulated joint to electrically isolate each end of track within the VMF. This will allow the staff to perform maintenance on a married pair at one end of the track while simultaneously allowing the other end of the track to remain under power for movement of vehicles. Each segment of trolley wire will have its own feeder cable from the DC switchboard.

The trolley stinger will consist of an overhead rail, traveling power contractor box, and trolley bug stick which will attach to the vehicle pantograph. The trolley stinger will allow maintenance staff to move vehicles on Tracks 3 and 4 under power without the benefit of an overhead contact wire. The overhead rail will carry 600 volt dc power along the length of the building adjacent to the track. The traveling contractor box will slide along the length of the rail and will close in when power is needed. The trolley bug stick will connected to the contractor box through a hanging cable. The trolley big stick will be fused to protect personnel when attaching to the vehicle pantograph.

The auxiliary house power plugs consists of a contractor box and cord/plug assembly that will provide a source of DC power for the on-board systems when the pantograph is not connected to the overhead contact system. The cord and plug assembly allows the maintenance personnel to connect the power feeder into an on-board receptacle inside the vehicle. The contractor box allows for the maintenance personnel switch the power on and off as needed. The auxiliary house power plugs will be located on the floor adjacent to each of the four VMF tracks.



The building fire protections systems will be designed and selected based current codes and the requirements of FM Global. We will select systems based on an area's purpose and if it is temperature-controlled. We will use a full wet fire sprinkler system, interconnected with the fire alarm system, for areas within the VMF and Transportation building. All Project areas will have readily available fire extinguishers in accordance with applicable codes.

An emergency trip system will be provided to allow maintenance personnel to remotely open power the power feeders in case of emergency or hazardous conditions. The system consists of local trip stations and a main control panel to be located in the foreman's office. Trip stations will be located adjacent to each track maintenance area. The button will trip and lock out the local feeder circuit at the DC switchboard and send an alarm to the main control panel. After the condition is clear, the alarm is reset at the main panel which releases the lockout allowing the feeder circuit to be reclosed for service.

The control system for the traction power equipment will include a gate interlock system which ties the DC switchboard to the raised platform access gates. Each platform gate will be provided with lock that is held in place while the local power feeder circuit is closed preventing personnel from entering an area with live power present. The lock is released when the power source is opened allowing personnel to enter under safe conditions. Power cannot be turned back on until personnel leave the area and the gates are closed.

General Design Approach to Mechanical Systems including HVAC, Plumbing, and Drainage Systems, and Equipment Selection. The mechanical systems design will provide a safe, comfortable, and productive work environment for the activities of the maintenance staff activities.

► **HVAC.** HVAC systems will be based on ASHRAE and current codes, including the Massachusetts Energy Code. We will use Trane Air Conditioning Economics (TRACE) software to perform heating, ventilating, and cooling calculations. All sheet metal ductwork will comply with Sheet Metal and Air Conditioning Contractors' National Association's duct construction standards.

Fire and smoke dampers will be provided in fire-rated partitions. Air registers grilles and diffusers will be selected to provide the required throw and spread, with minimal noise in occupied rooms. Intake and exhaust louvers will be storm-rated in accordance with the Air Movement and Control Association's requirements. Ventilation systems will be provided with demand control ventilation.

The VMF's heating and ventilation systems will include gas fired rooftop units, indoor radiant heaters, and unit heaters.

The rooftop units will provide 100% outdoor air supply into the maintenance facility through drum louver diffusers mounted up high, which discharge downward at an adjustable angle to reach the finished floor. We will extract exhaust airflow through low-exhaust registers in maintenance pits and along column lines and in high-duct mounted exhaust registers. The heating and ventilating units serving the shop areas will utilize high efficiency gas burners, energy recovery from leaving exhaust air, and variable frequency drives for variable airflow capacity.

The fan speeds of the variable capacity heating and ventilating units will automatically modulate in response to variations in carbon dioxide gas concentrations. If carbon monoxide gas concentration rises above 25 parts per million, the carbon monoxide gas detection monitoring and control systems will operate to automatically index the associated zones' ventilation system to the high-speed, 100% outside air mode of operation, in accordance with OSHA and NIOSH standards for time-weighted average exposure limits.

In addition to the rooftop equipment, gas fired radiant heaters will be provided over maintenance pit areas to heat the area around the tracks for occupant comfort. Areas with clearance constraints for installing radiant heat will be provided with gas fired unit heaters. This heating capacity will be for the non-ventilation building losses and will handle the demand of the building during unoccupied hours when the ventilation system is turned off.

► **Plumbing and Drainage.** We will design the VMF's plumbing systems in accordance with 248 CMR, which includes selecting products from the approved-products list that meet the EPA's WaterSense criteria. We will incorporate proper backflow prevention for all domestic and industrial water systems.

Domestic hot water heating will be designed in accordance with American Society of Heating, Refrigerating, and Air-Conditioning Engineers (ASHRAE) requirements. Before use, we will commission the domestic hot water heating system.

Insulation will conform to the Massachusetts Energy Code. Sanitary wastes will be collected separate from industrial wastes. Industrial wastes will flow through an approved oil water separator before discharging to the sanitary waste system. Clear condensate wastes will direct to the storm water system. Leak detection alarms will route to the automated control system and the MBTA's Operations Control Center.

Storm drainage systems for buildings and canopies will conform to 248 CMR. Compressed air systems will be designed in accordance with the American Society of Plumbing Engineers (ASPE) manual.

► **Equipment Selection.** Mechanical and plumbing equipment will meet the needs of the Project, and applicable code requirements. Designers will evaluate each space or system and select equipment based on the demands and intent of the design. Experience on past projects, maintenance considerations, and manufacturer recommendations will all be used in evaluating equipment for the design.

Main Mechanical Equipment Schedules. As shown in Drawing VMF-014 at the end of this section, the HVAC equipment consists of heating and ventilating air handlers with energy recovery, gas fired unit heaters, exhaust fans, and variable refrigerant flow split systems, electric baseboard heat, and infrared heaters.

The plumbing equipment consists of the following:

- ▶ Two gas fired hot water heaters that serve the building
- ▶ Emergency eye wash/shower fixtures throughout the building
- ▶ An air compressor, air receiver, and dryer located in Compressor Room 114 on the northwest side of the building
- ▶ Kitchen sink located in both break rooms
- ▶ Mop sink located in each janitor’s closet
- ▶ Shower and two lavatories in each locker room
- ▶ Drinking fountain just outside the locker rooms

Building Automated Control System. An automated control system will operate and manage the mechanical systems, including heating, ventilating, air conditioning, lighting controllers, domestic hot water, drainage alarms, and air compressor equipment. The system will meet ASHRAE 135 standards for BACnet, an open-source protocol for Building Automation and Control Networks.

The mechanical HVAC equipment will have zone sensors and thermostats in the maintenance areas to control the ventilation system and supplemental heaters. Local thermostats will control systems in staff and support spaces. These systems and equipment will connect to the BMS for monitoring and control by the MBTA.

The BMS system will connect to the SCADA/Programmable Logic Controller system to report all alarms and monitored points to the MBTA Operations Control Center. This will allow real-time alerts for high or low temperatures, equipment status, water leak detection, and other alarms.

Proposed Electrical Utility Service Supply Point. We will work directly with the utility company to develop an efficient use of space that meets their requirements while minimizing impacts to the VMF. Per the RFP the Transportation Building electrical service is being fed from the VMF. Please refer to Drawings VMF-002 and VMF-003 at the end of this section.

Electrical Drawings

Electrical Site Layout Showing Location of Incoming Electrical Services, Switchgear, and Duct Banks to Each Building, Substation, and Traction Power Substation. We have engineered an efficient and cost effective utility co transformer location. The location shown on the civil site and utility plan attempts to minimize the length of secondary conduits between the utility transformer and main electric room in the NE corner of the VMF. In addition, all site conduit and duct bank runs take the most direct path and route to their intended location to minimize voltage drop and feeder lengths. Please reference drawings VMF-002 and VMF-003 at the end of this section.

“
GLX Constructors Team
Member, Middlesex,
regularly performs work
for local utilities that has
included major projects
for Eversource. Our team
is equipped with the
knowledge to quickly
negotiate, design, and build
to Eversource requirements.”

Single Line Diagram, Preliminary Sizing of Equipment and Feeders.

Our Team’s expertise with previous maintenance facility projects, including our recent involvement with the design of the MBTA Orange Line Wellington Car House renovations has allowed us to apply historical data to assist in establishing the properly-sized electric service for the VMF. From historical billing data and the existing main switchgear size at the Wellington Carhouse, our team has projected that a maintenance facility of this size and type will require approximately 17 Watts/s.f. which equates to a service size of 2000A at 480V, 3 phase, and 4 wire. This assumption has been bolstered by our development of the baseline one-line schematic diagram of the main electrical power distribution system, based on the aforementioned wattage/square foot criteria and load requirements for the major maintenance equipment for the VMF.

Please reference drawings VMF-010 at the end of this section and the expected electrical demand calculations below.

Location Points for Tie-in to Local Electrical Utility. Please reference drawings VMF-002 and VMF-003 at the end of this section.

Riser Diagrams for Fire Alarms and Miscellaneous Systems. Fire Alarm system devices shown in the one line Fire Alarm system schematic diagram drawing have been located in accordance with code requirements. The main fire alarm control panels within the VMF have been centrally located. Digital annunciators have been shown and their locations will be confirmed by the team during design. For riser diagrams for fire alarms and miscellaneous systems, please refer to Drawing VMF-011 at the end of this section.

Mechanical Drawings to Indicate Design Intent of All Building Services Mechanical Systems

HVAC. The VMF mechanical systems design is focused around the Service Floor Area. The heating and ventilating is accomplished by eight roof-mounted air handling units. Refer to drawing VMF-013 for the roof plan of these equipment and drawing VMF-012 for the interior ductwork from these units.

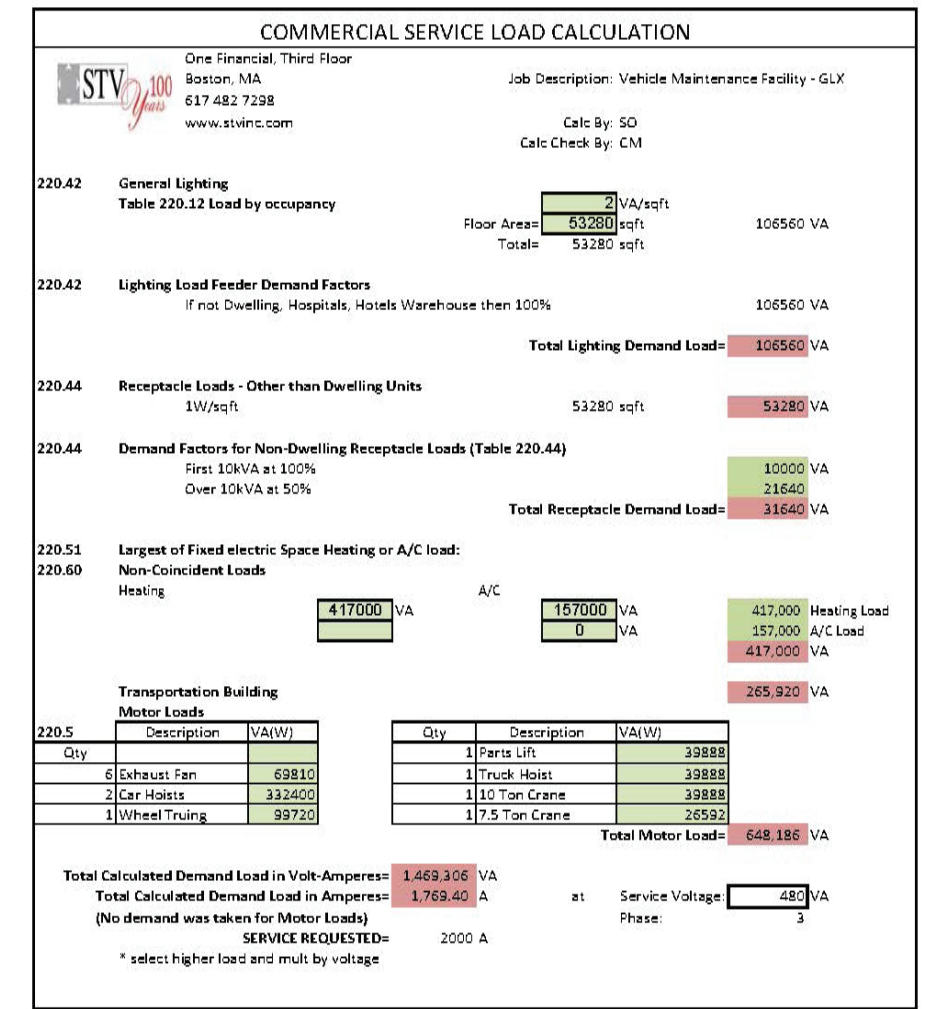

Figure 4.5-1. Commercial Service Load Calculation.



Figure 4.5-2. Roof-Mounted Air Handling Unit. Example.

The supply of heating and ventilation air down to the floors is accomplished with drum louver diffusers mounted high, discharging downward at an adjustable angle to reach finished floor.

Summer ventilation of the shop area is accomplished with six rooftop exhaust fans and is designed to draw additional air through the overhead doors.

The staff support spaces connected to the shop area are all designed to consider the airflow between spaces. Heating and cooling is accomplished with variable refrigerant flow systems. Ducted split systems are located above the ceiling of all occupied spaces. Ventilation air is provided to each split system by a dedicated energy recovery device with fixed plate heat exchanger, which will exchange energy from the locker room exhaust air to pretreat incoming ventilation air. Supplemental heat is provided by electric baseboard in the event the system experiences winter issues due to ice buildup or below zero temperatures.

The storage rooms are designed with dedicated air handling units to both heat and ventilate the space. Wall mounted louvers and inline exhaust fans will provide summer ventilation.

A similar type system will also be employed for the HVAC system for the Transportation Building.

Fire Protection. To confirm existing water pressure in the vicinity of the VMF site, our team performed a hydrant flow test to form the basis of our hydraulic calculations. This determined a fire pump was not required for the VMF. This allowed the fire protection main double check valve and alarms as well as the main domestic water service backflow preventer to be housed in the allocated square footage in the Fire Protection Rm No. 118 called out in the Volume No. 2 Project Definition plans.

A wet fire sprinkler system with two zones will be provided, one zone for the East side of the building, the other for the West side. The fire sprinkler system was designed in accordance with NFPA 13.

The hydraulic calculations, based on the hydrant flow test, indicate that a 10" fire sprinkler pipe to the building, with two 8" fire sprinkler risers with alarm assemblies is sufficient to provide fire protection to comply with NFPA 13.

A wet-type fire protection system will also be provided for the Transportation Building.

Plumbing. Natural gas, sanitary waste, industrial waste, domestic cold water, domestic hot water, and compressed air systems have been sized for the VMF building. Gas, sanitary water, domestic cold, and hot water system will also be provided for the Transportation Building in accordance with 248 CMR and the International Plumbing Code.

Drainage. The storm drainage system is sized in accordance with 248 CMR and the International Plumbing Code. Roof drains have been identified at all low points which are shown on Drawing No. VMF-005. Double roof drains are provided to comply with applicable codes for overflow protection. Roof storm drainage is collected inside the building via a network of piping which exit the VMF building at three separate locations shown on Drawing No. VMF-002 which in turn discharge to the underground storm water piping. The roof drainage system for the Transportation Building will be collected via a system of gutters and down spouts which will be collected and discharged to underground storm water piping. Refer to Drawing No. VMF-003.

4.5.C INDUSTRIAL PROCESS AT VEHICLE MAINTENANCE FACILITY

The VMF design will accommodate daily inspections and interior cleaning demands required for 43 LRVs, while facilitating light servicing, inspection, and maintenance tasks. The run-through track configuration will accommodate varying work-flow configurations.

Design Approach Using Narrative and Design Drawings, Demonstrating How GLX Constructor's VMF Design Conform to Requirements

Description of the Functional Design Concept Proposed for the VMF. The VMF is designed with four run-through tracks, each capable of accommodating two pairs of vehicles and allowing 16 total vehicles to be housed at once. Tracks 1 and 2 have pit/pedestal track configurations, and they are equipped with overhead DC power systems that will allow the vehicles to enter and exit the shop using their own power. This configuration will facilitate:

- ▶ Easy vehicle movements for inspection and maintenance tasks
- ▶ Access beneath the vehicles to perform inspection of the brake discs
- ▶ Fluid change-outs

We have configured Track 3 with a flat floor maintenance/inspection position for two vehicles on half of the track. A flat floor with a wheel truing machine pit for wheel re-profiling composes the other two vehicle maintenance positions.

We have provided Track 4 with car hoist equipment at the north and south ends of the shop that accommodates lifting one vehicle at each half of the shop. This facilitates change-out of the trucks. The car hoist position at the north end of the shop is equipped with perpendicular shop rails that allow easy transfer of trucks from the lifting position into the truck repair shop.

There will not be an overhead DC power system along Tracks 3 and 4 so that the area can be served by a 10-ton bridge crane to handle trucks and roof-mounted equipment. The VMF will have space provided to accommodate rolling platforms. The platforms have not been included in our proposal per the Technical Provisions.

A 7.5 Bridge crane in the loading dock area will accommodate supply deliveries that cannot be transported via forklift to various shops and storage areas throughout the VMF. The bridge crane also picks wheel sets and truck assemblies from Track 4 and transports them to the truck shop and wash area.

Interface of the VMF with the Main Line. Efficient entry and exit from the new Inner Beltway yard is critical due to the yard being the terminus point for two light rail branch lines. The mainline interface must support the requirement that D-Line service run at a five-minute headway and the E-Line service run at a six-minute headway.



Figure 4.5-3. Rendering of service pit areas in the VMF.

Although yard switches will be hand thrown, we will accomplish main line interfaces from the yard leads by activating push button boxes, which have proven to be a safer, more reliable design than routing onto the main line via AVI-activated switches.

Because switches are interlocked with the signal system, Operators' push button requests will not activate switches if the signal system determines the routing is not safe. For an additional layer of safety, we will install switch heaters at switches that control access from the main line to the yard leads.

Storage on the yard leads at strategic junctures will allow for immediate insertion into revenue service of 'hot spares' should a train become disabled or should the Operation Controls Center (OCC) or field supervision call for extra service.

Storage of the Revenue Vehicles. The yard will have the capacity to safely store 43 vehicles and will support the ability to populate the D Line with 42 cars and the E Line with 34 cars in an efficient manner, requiring less dead heading and inefficient run cuts emanating from the Riverside Yard. Yard illumination will meet the MBTA's lighting standard requirements for ambient foot candles.

Paved walkways, painted with non-slip coating, help prevent slips, trips, and falls. Distinct clearance lines provide critical information to Operators and Yard Shifters regarding appropriate stopping/parking locations to avoid potential accidents.

Probing antennas can easily examine stored vehicles prior to their next service run to make certain customers' latest transactions are properly captured.

Proposed Shop Equipment List for the VMF. We will provide over 140 pieces of equipment in the VMF as indicated by the following list of equipment types, identifiers, and quantities.

Equipment ID #	Description	Quantity
1005	PEG TOOLBOARD	6
1234	SPILL CONTAINMENT PALLET	3
1270	STORAGE RACK, 72 BIN	10
1290	OIL FILTER CRUSHER	2
1295	BULK STORAGE RACK	4
1325	PALLET RACK, 3 LEVEL	9
1330	PALLET RACK, 3 LEVEL	1
1340	PALLET RACK, 3 LEVEL	7
1345	PALLET RACK, 3 LEVEL	6
1511	SHELVING UNIT (2 STARTERS/2 ADD-ON)	4
1516	SHELVING UNIT	18
2123	TRASH COMPACTOR	1
2129	VERTICAL BALER	1
2629	WISE	14

Equipment ID #	Description	Quantity
3025	PARTS CLEANING TANK	8
3050	HIGH PRESSURE WASHING	1
5041	DEIONIZED WATER PORTABLE CART	2
7522 7706	AIR PISTON PUMP	2
7706	WASTE FLUIDS RECEIVER	4
7937	INTEGRAL PUMP, WASTE TANK	1
8002	PORTABLE WORK PLATFORM	8
8005	ROOF WORK PLATFORM (FUTURE)	2
8117	WORKBENCH	14
9105	10 TON BRIDGE CRANE	1
9126	7.5 TON BRIDGE CRANE	1
9307	NARROW AISLE ELECTRIC FORKLIFT	1
9400	IN-GROUND LRV HOIST	2
9443	TRUCK REPAIR HOIST	1
9705	TWO STOP PARTS LIFT	2
9815	PALLET JACK	4

Figure 4.5-4. Proposed Shop Equipment List for the VMF.

The fixed LRV Hoists (Equipment ID 9400) on Track 4 of the VMF will be high pressure hydraulic hoists. These hoists use less hydraulic fluid than typical hydraulic hoist systems, and they provide an advantage over screw jack hoists by making it possible for the lifting frame to rotate 90 degrees to align with perpendicular tracks. This simplifies the movement of trucks from beneath the vehicle into the truck shop and eliminates the need for separate turntable equipment.

There are two main storage areas within the VMF which utilize many different types of storage equipment to move anything ranging from traditional pallet racks to small parts storage bins. The storage area west of Track 1 has narrow aisles between storage racks; therefore, it requires a Narrow Aisle Electric Forklift (Equipment ID 9307) to load and unload the pallet racks. The Narrow Aisle Electric Forklift has forks that rotate 180 degrees, which allows it to operate in reduced-width aisles. The narrow aisles and high pallet storage minimize floor space and maximize the storage volume.

Narrative on the Industrial Design. We will develop an industrial design that promotes efficient performance of the maintenance functions necessary to meet daily car counts and keep the Green Line fleet in a State of Good Repair (SOGR).

A clear definition of facility requirements and function are important in developing plans for the repair shops, service and inspection areas, and ancillary

facilities. We understand the objectives of this facility are to insure the reliability of the overall fleet, minimize maintenance for unscheduled repairs, and provide a system for maintaining a clean fleet. We will meet those objectives and deliver a quality industrial design by implementing the following design standards.

- ▶ Design facilities consistent with property constraints, track and yard constraints, and operational philosophies, as well as the operating maintenance practices of the MBTA.
- ▶ Design and develop buildings that will be durable, cost-effective, aesthetically pleasing, and easily maintained.
- ▶ Developing an operational work flow plan based on our industrial engineering expertise that will properly accommodate the required functions, while optimizing personnel and efficient interaction with operating equipment.
- ▶ Incorporate safe, durable, and proven service equipment.
- ▶ Design utility systems that will provide for proper drainage, water supply, lighting, ancillary power, waste disposal, and communications, which are consistent with the objectives of the facilities.
- ▶ Use proven functional design elements for each area required in the facility. For example, a design for a repair bay will be developed based on previous proven designs and current design parameters used by the MBTA.
- ▶ Create facilities that are safe, productive, warm in the wintertime, cool in the summertime, and engineered to increase productivity while eliminating accidents.
- ▶ Place of ducts, piping, and conduits to promote access and increase sight lines.
- ▶ Place controls so that the operator views are unobstructed.
- ▶ Increase ventilation rates or induce positive room pressures at locations where work operations are known to potentially diminish air quality.

Drawings of the Design Approach for the VMF

Site Plans. Drawings that demonstrate how the design for the VMF will conform to the requirements of the Volume 2, Technical Provisions, Section 10 are included at the end of this section.

Proposed Track throughout the VMF. We have developed track plans for the VMF/Car Storage Yard with the following:

- ▶ Three yard Lead Tracks
- ▶ Eleven car storage tracks
- ▶ Two ladder tracks
- ▶ A loop track around the facility

- ▶ A storage track adjacent to the VMF building
- ▶ Four VMF tracks within the building

Crossovers are provided to allow for cars to access the VMF building from any storage track. We have designed track horizontal alignments within the VMF/Car Storage Yard that follow Section 10.2 of the Technical Provisions. These alignments replicate the Definition Plan's horizontal alignments except for the loop track to improve the grading at Third Avenue entrance.

GLX Constructors has designed track vertical profiles within the VMF/Car Storage Yard that follow Section 10.2 of the Technical Provisions.

Track Construction Details, Diagrammatic Representation, and Proposed Limits for Each Track Type. Please reference proposed track drawings at the end of Section 4.6 of this document.

4.5.D BUILDING STRUCTURES AT THE VEHICLE MAINTENANCE FACILITY

Approach to Demonstrating How the Design for the VMF, Stations, Underpasses, and Associated Facilities Conform to Structural Requirements

Design Criteria and References to the Applicable Standards. The VMF's structural design will conform to the specific requirements as identified in the Technical We understand that the order of precedence of these requirements will be those specifically identified in the Technical Provisions, followed by the codes and standards in Section 13.2.2 in the order listed.

Design or Specification Measures to Meet Serviceability Criteria. We will use a combination of construction, expansion, and contraction joints in the design of all concrete structures to control the effect of expansion and shrinkage associated with concrete curing. These measures, along with control joints, will mitigate the extent of any potential shrinkage cracking.

Description of the Structural Elements, Including, Support of Excavation, Foundation, Floor, Roof, Framing System, and Lateral Load Resisting System. The foundation system will be a combination of pile caps and grade beams. Piles are located under pile caps at each building column. These pile caps are connected by a series of grade beams, which will support the floor slabs and transfer tributary loads to the piles. Some piles will support the slab under Tracks 3 and 4 and the associated pits for lifts and wheel truing.

The floor slabs will be structural slabs supported by the grade beam system. The only exception will be the slabs in the area of Tracks 3 and 4, which, as noted earlier, will be directly supported by piles.

The building superstructure will be a steel frame structure comprising rolled shape columns supporting two bridge cranes and the roof structure. The roof

framing system will be composed of joist members for the transverse girders and longitudinal purlins.

Moment connections between the joist girders and the columns will provide for the lateral load resisting system. Longitudinal load resistance will be provided by bracing in one or more bays in each of the exterior longitudinal column lines.

We do not anticipate excavation support for constructing the VMF foundation system. Based on the area's geotechnical information, the groundwater table is high (3 to 5-feet below existing grade) and dewatering may be required at the deep pits on Track 3 and 4.

Narrative of the Waterproofing System, Type, and Application. The waterproofing system will be a fluid applied membrane waterproofing system, consisting of a membrane adhered to the vertical surface of the pits with an adhesive. When necessary, a mud slab will be poured after the piles are driven to provide a smooth and level surface for the waterproofing membrane. To secure a watertight system, we will provide a proper length of lap joints where the horizontal and vertical sections of the membrane intersect.

Design to Mitigate Frost Heave. To mitigate frost heave, we will place the top of pile caps, also the bearing surface for the grade beams, at least 4-feet below grade.

Confirmation That All Structures Can Be Constructed within the Project ROW, including Consideration for Any Temporary Structures and Shoring That May Be Required. GLX Constructors has carefully reviewed the required work and compared this effort against the documents provided by the MBTA with the RFP. In all cases, we do not anticipate that temporary shoring or temporary structures will be required to construct the VMF and Transportation Buildings, trackwork, retaining walls, utilities, or any other site related work or project elements.

Representative Structural Drawings

Drawings requested for the following sections are included at the end of this section.

Support of Excavation Systems. The design of the VMF only requires excavation to construct the depressed and pit portions of the floor, pile caps, grade beams and utilities. Open cut excavations will be used to construct these portions of the facility. No excavation support systems are currently anticipated.

Foundations, Floor, Roof, and Structural Framing Systems, including Materials and Spans. The foundations for the VMF will consist of 14-inch square, 100-ton precast prestressed concrete (PPC) that will transfer the structural loads from the building structure and ground floor slab through the existing unsuitable fill and underlying clay layers to the underlying glacial till and weathered bedrock/bedrock.

Please reference the foundation, floor, roof, and framing plans at the end of this section.

Column Spacing and Layout. Column spacing and layout are provided by drawing VMF-004 at the end of this section.

Drainage and Waterproofing System. The Project will reduce impervious areas and create less runoff than the current site condition. Positive drainage for the VMF will be divided in two sections. The southern section which discharges to Red Bridge Pump Station and the northern section which discharges into an existing system along tracks near the west edge of the commuter rail facility.

We will provide detention systems for both buildings such that proposed storm water runoff volume and rate does not increase. Water quality improvements will be further evaluated in design development.

Waterproofing systems will be applied to the deep pits at Tracks 3 and 4.

Demonstration That All Structures Can Be Constructed Within the Lands Including Consideration for Any Temporary Structures and Shoring That May Be Required. As depicted by the drawings at the end of this section, all structures can be constructed in the lands based on the documents provided by the MBTA with the RFP. Temporary structures or shoring are not anticipated to construct the VMF facility.

Design to Mitigate Frost Heave for Temporary and Permanent Structures. The top of the pile caps and bottom of grade beams will be constructed to be at least 4-feet below grade for frost protection.

GLX Constructors has reviewed the Volume 2 Technical Provisions and the applicable Project Definition Plans, for the VMF and Transportation Building. By virtue of past experience and anticipated alignment sessions with the MBTA we will fully understand and design the VMF and Transportation Building to effectively serve and support the Green Line Extension.

ITP Request	RFP		
	Drawing Number	Drawing Title	Reference Section or Drawing
A5.2.5.A.2.a	VMF-001	Overall Site Plan	
A5.2.5.A.2.b	VMF-002	VMF Site Plan	
A5.2.5.A.2.b	VMF-003	Transportation Building Site Plan	
A5.2.5.A.2.c	VMF-004	Floor Plan	
A5.2.5.A.2.c	VMF-005	Roof Plan	
A5.2.5.A.2.d	VMF-006	Exterior Elevations	
A5.2.5.A.2.d	VMF-007	Building Sections	
A5.2.5.A.2.d	VMF-008	Building Sections	
A5.2.5.A.2.f			4.5 (VMF-007, VMF-008)
A5.2.5.A.2.g			4.5 (VMF-007, VMF-008)
A5.2.5.A.2.h	VMF-009	Wall Sections	
A5.2.5.B.2.a			4.5 (VMF-002, VMF-003)
A5.2.5.B.2.b	VMF-010	Electrical One Line Diagram	
A5.2.5.B.2.c			4.5 (VMF-002)
A5.2.5.B.2.d	VMF-011	Electrical Fire One Line	
A5.2.5.B.3	VMF-012	Mechanical Overall Work Plan	
A5.2.5.B.3	VMF-013	Mechanical Roof Plan	
A5.2.5.B.3	VMF-014	Mechanical HVAC Equipment Schedule	
A5.2.5.B.3	VMF-015	Vehicle Maintenance Facility Plumbing and Fire Protection Floor Plan	
A5.2.5.C.1			4.5 Narrative
A5.2.5.C.2.a			4.5 (VMF-002)
A5.2.5.C.2.b			4.6 (C-050, C-051, C-052)
A5.2.5.D.2	VMF-016	Foundation Plan	
A5.2.5.D.2	VMF-017	Pit Slab Plan	
A5.2.5.D.2	VMF-018	Main Floor Slab Plan	
A5.2.5.D.2	VMF-019	Framing Plan – Column and Track Pedestals	
A5.2.5.D.2	VMF-020	Roof Framing Plan	
A5.2.5.D.2	VMF-021	Longitudinal Building Section	
A5.2.5.D.2	VMF-022	Transverse Building Section	
A5.2.5.D.2	VMF-023	3D Representation	

Technical Solutions Drawing Matrix.



Conceptual Draft
For Discussion
Purposes Only

Conceptual Draft
For Discussion
Purposes Only

Conceptual Draft
For Discussion
Purposes Only



PLotted: 08/13/17 10:56AM BY: HART
DRAWING: I:\PROPOSALS\GLX\TECH DESIGN\VMF_C-SP-VMF-001.dwg [VMF-001] 09/07/17 5:35PM

PROPOSAL

MASSACHUSETTS BAY TRANSPORTATION AUTHORITY
T
GREEN LINE EXTENSION PROJECT
MBTA CONTRACT NO. E22CN04
CAMBRIDGE/SOMERVILLE, MASSACHUSETTS

OVERALL SITE PLAN

1"=60'

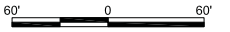

GV20170258-275.pdf

ISSUE	DATE	DESCRIPTION	BY	CHKD	APP.	SCALE:	DRAWN BY:	DESIGN BY:	CHECK BY:	PLAN NO.:	ISSUE
	SEPT. 28, 2017		DK	DK	ND	1"=40'	DK	DK	ND		
DATE: SEPT. 28, 2017										SHEET: VMF-001	

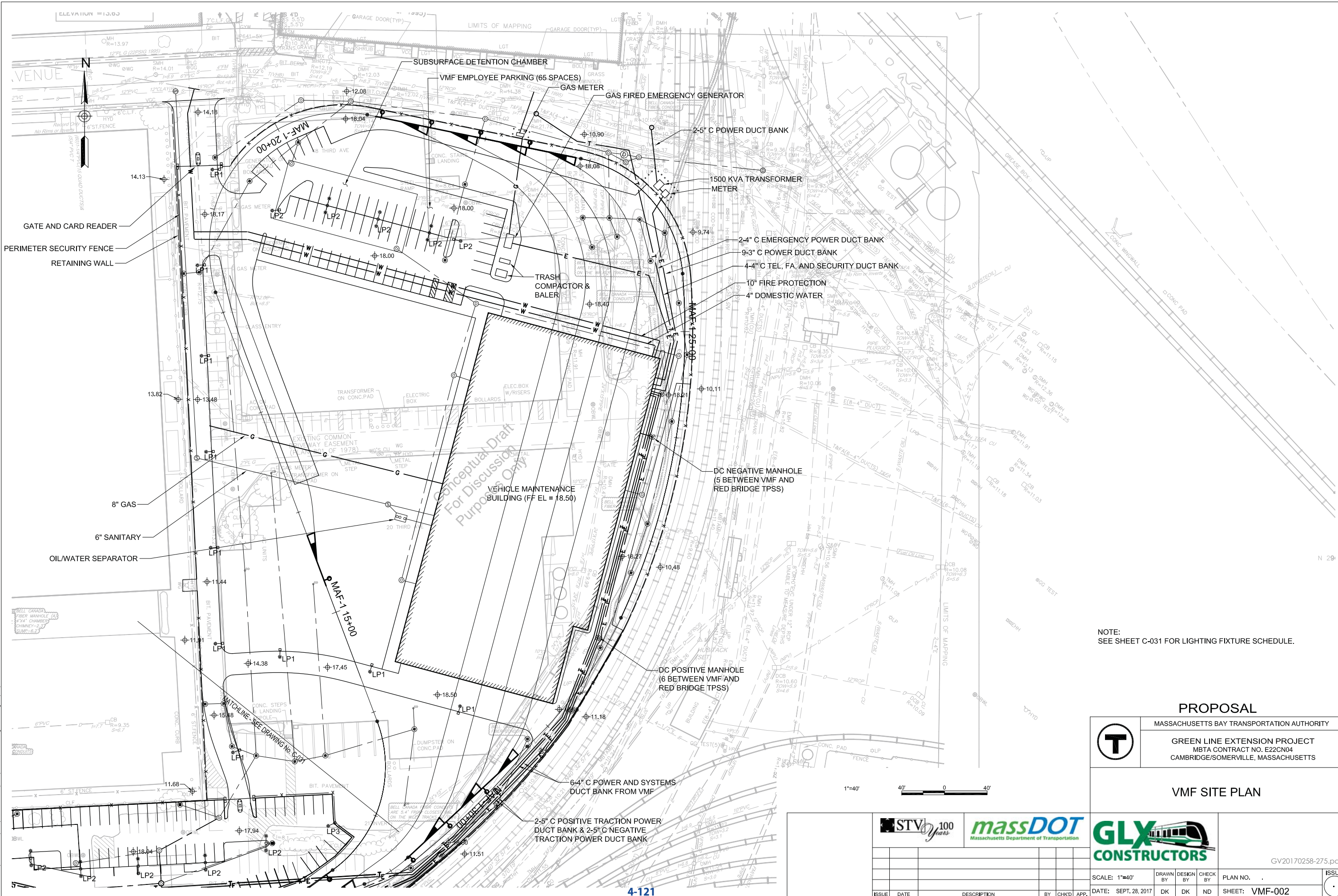

NOTE:
SEE SHEET C-031 FOR LIGHTING FIXTURE SCHEDULE.

PROPOSAL

MASSACHUSETTS BAY TRANSPORTATION AUTHORITY
GREEN LINE EXTENSION PROJECT
MBTA CONTRACT NO. E22CN04
CAMBRIDGE/SOMERVILLE, MASSACHUSETTS

VMF SITE PLAN



GV20170258-275.pdf



ISSUE	DATE	DESCRIPTION	BY	CHKD	APP.

SCALE: 1"=40'	DRAWN BY: DK	DESIGN BY: DK	CHECK BY: ND	PLAN NO.:	ISSUE:
DATE: SEPT. 28, 2017				SHEET: VMF-002	

PLOTTED: 09/13/17 11:04AM BY: HART
 DRAWING: I:\PROPOSALS\GLX\TECH DESIGN\VMF\C-SP-VMF-002.dwg [VMF-002] 09/13/17 11:07AM

LUMINAIRE SCHEDULE											
LUMINAIRE MARK	DESCRIPTION	MANUFACTURER	CAT. NUMBER	DLC LISTED	LAMPS TYPE	MOUNTING	VOLTAGE	WATTAGE	DISTRIBUTION	POLE HEIGHT	ARM LENGTH
LP1	SHOEBOX LUMINAIRE	BEACON	VPS-60NB-136-3K-T2-480V	X	LED	POLE	480	136	TYPE III	30'	5'
LP2	SHOEBOX LUMINAIRE	BEACON	VPS-48NB-110-3K-T3-480V	X	LED	POLE	480	110	TYPE II	30'	5'
LP3	SHOEBOX LUMINAIRE	BEACON	VPS-60NB-137-3K-T3-480V	X	LED	POLE	480	136	TYPE III	30'	5'
LP4	SHOEBOX LUMINAIRE	BEACON	VP-L-64NB-135-3K-T3-480V	X	LED	POLE	480	135	TYPE III	35'	0'
LP5	SHOEBOX LUMINAIRE	BEACON	VP-L-64NB-135-3K-T3-480V	X	LED	POLE	480	135	TYPE III	35'	14'

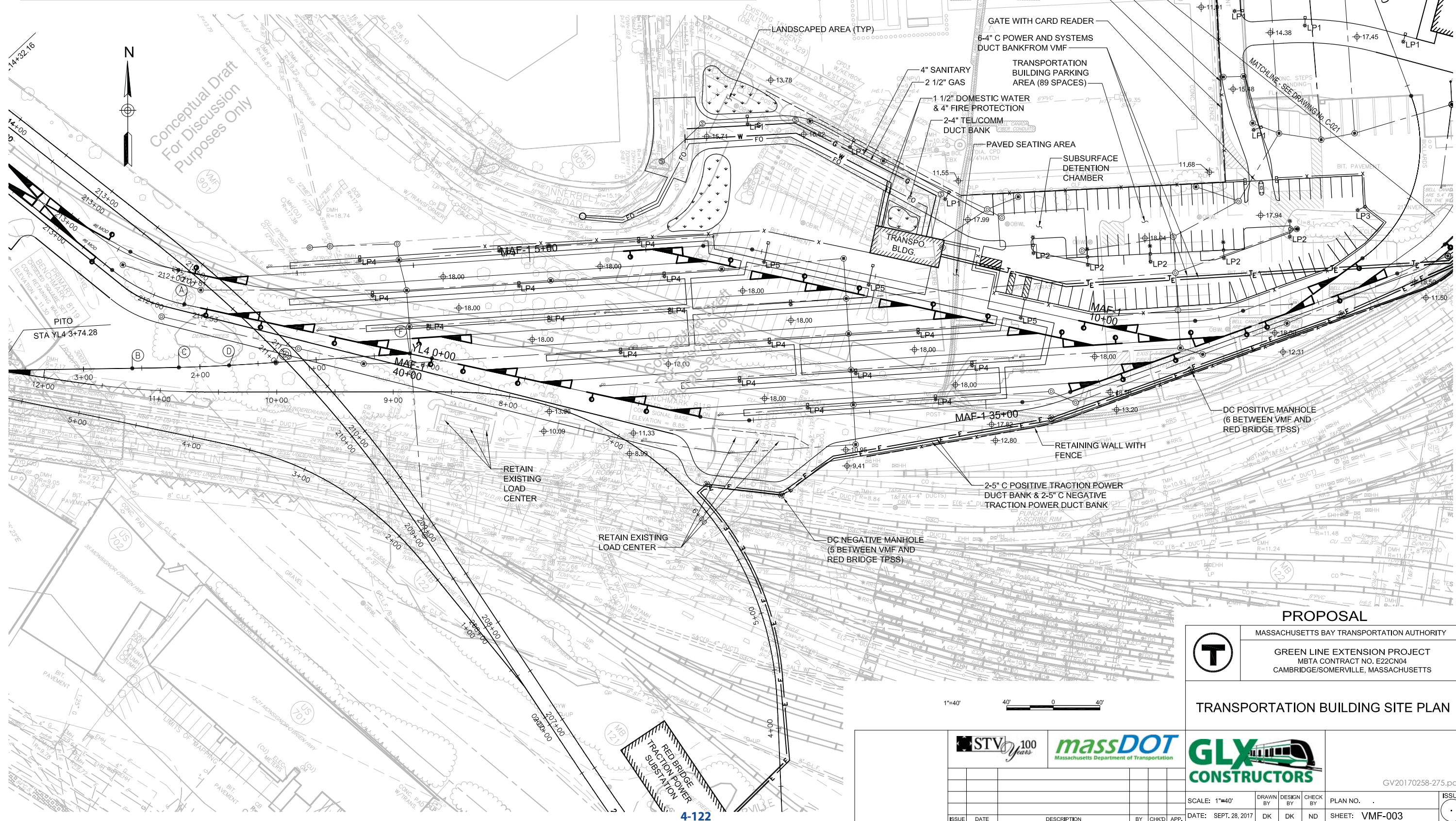

Conceptual Draft
For Discussion
Purposes Only

PROPOSAL
 MASSACHUSETTS BAY TRANSPORTATION AUTHORITY
 GREEN LINE EXTENSION PROJECT
 MBTA CONTRACT NO. E22CN04
 CAMBRIDGE/SOMERVILLE, MASSACHUSETTS

TRANSPORTATION BUILDING SITE PLAN



SCALE: 1"=40' DATE: SEPT. 28, 2017		DRAWN BY: DK DESIGN BY: DK CHECK BY: ND		PLAN NO. . SHEET: VMF-003	
ISSUE	DATE	DESCRIPTION	BY	CHKD	APP.

PLOTTED: 09/13/17 11:16AM BY: HART
 DRAWING: I:\PROPOSALS\GLX\TECH DESIGN\VMF\C-SP-VMF.DWG [VMF-003] 09/13/17 11:07AM

9/21/2017 1:25:17 PM \\stvgroup\stvinc.com\w\3\DCP\A\Vol9\Proposals\Green Line Extension\90_CAD Models and Sheets\07_A_Architectural\VMF_A_3D\0000.rvt

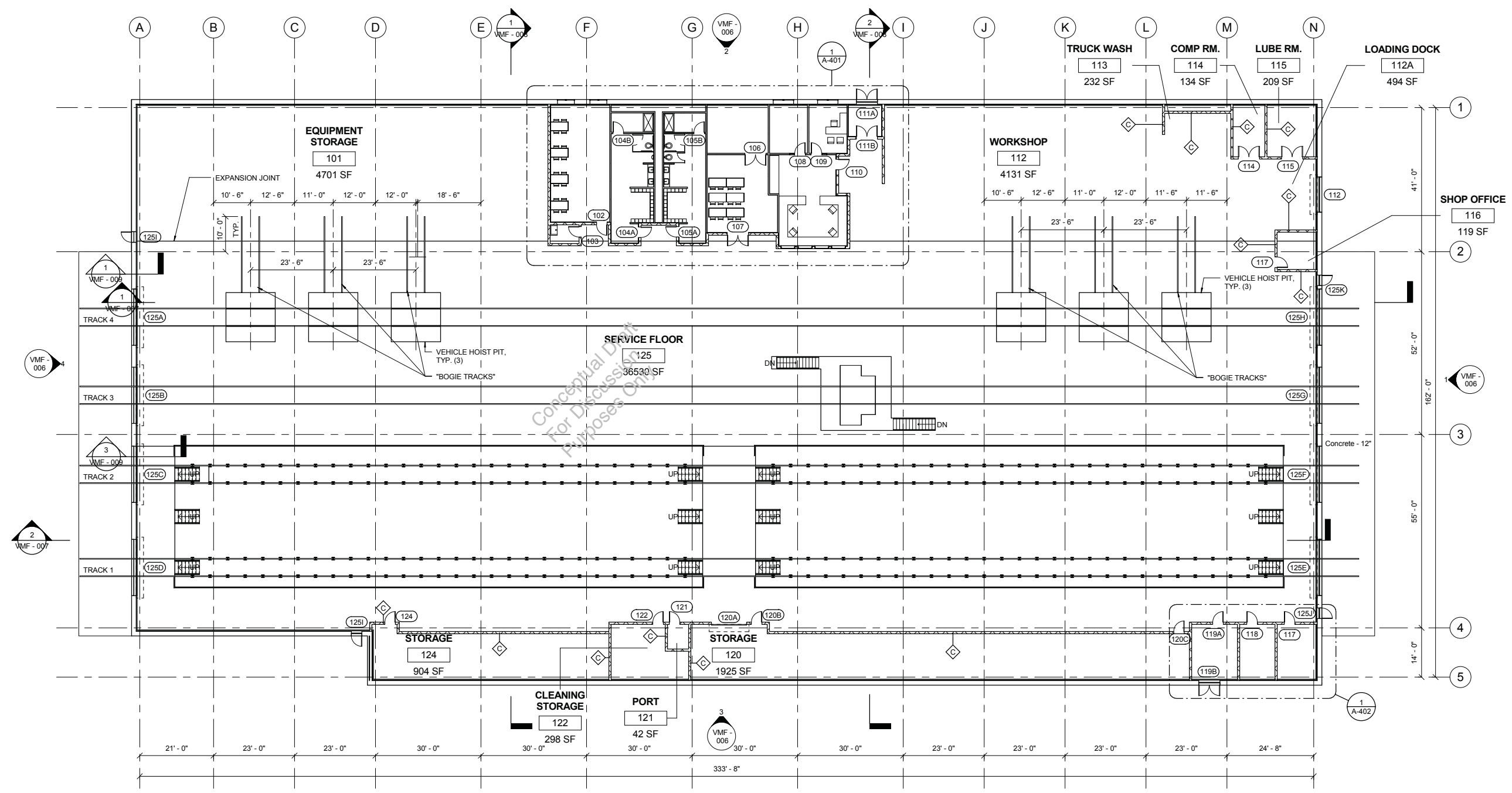

FIRST FLOOR PLAN

1/16" = 1'-0"
 0 8' 16' 32'

PROPOSAL

MASSACHUSETTS BAY TRANSPORTATION AUTHORITY
GREEN LINE EXTENSION PROJECT
 MBTA CONTRACT NO. E22CN04
 CAMBRIDGE/SOMERVILLE, MASSACHUSETTS

VEHICLE MAINTENANCE FACILITY FLOOR PLAN

Conceptual Draft
 For Discussion
 Purposes Only



GV20170258-275.pdf

SCALE: AS NOTED	DRAWN BY: SP	DESIGN BY: SP	CHECK BY: ND	PLAN NO.	ISSUE
DATE: SEPT. 28, 2017	DATE: SEPT. 28, 2017	DATE: SEPT. 28, 2017	DATE: SEPT. 28, 2017	SHEET: VMF-004	
ISSUE	DATE	DESCRIPTION	BY	CHKD	APP.

9/21/2017 1:25:18 PM \\stvgroup.stvinc.com\w3\CDP\A\Vol9\Proposals\Green Line Extension\90_CAD Models and Sheets\07_A_Architectural\VMF_A_3D\0000.rvt

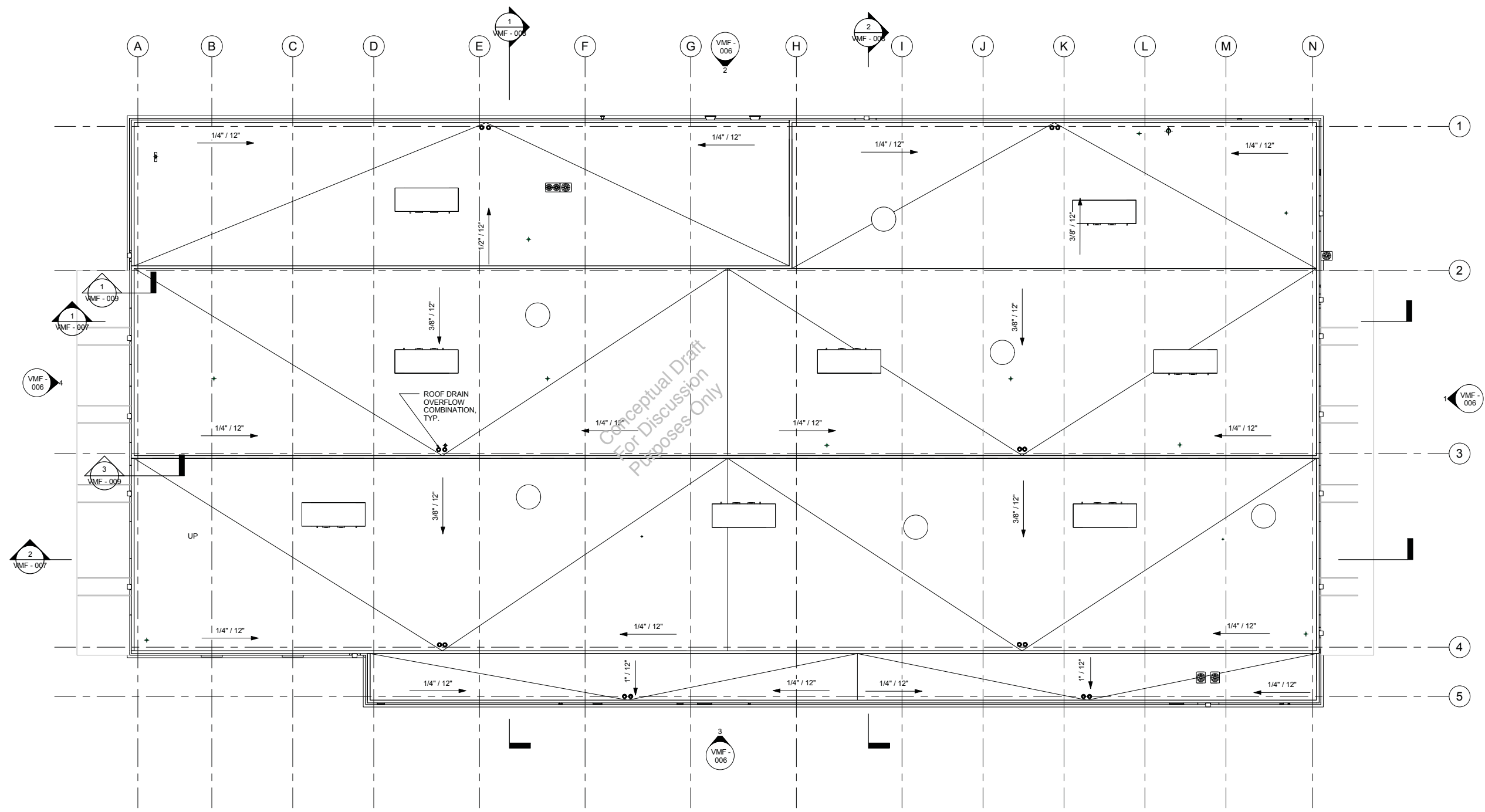

ROOF PLAN
1/16" = 1'-0"

Conceptual Draft
For Discussion
Purposes Only

PROPOSAL

MASSACHUSETTS BAY TRANSPORTATION AUTHORITY

T

GREEN LINE EXTENSION PROJECT
MBTA CONTRACT NO. E22CN04
CAMBRIDGE/SOMERVILLE, MASSACHUSETTS

**VEHICLE MAINTENANCE FACILITY
ROOF PLAN**

				GV20170258-275.pdf	
SCALE: AS NOTED		DATE: SEPT. 28, 2017	DRAWN BY: SP	DESIGN BY: SP	CHECK BY: ND
ISSUE		DATE	DESCRIPTION	BY	CHKD APP.
			PLAN NO.	ISSUE	
			SHEET: VMF-005	○	

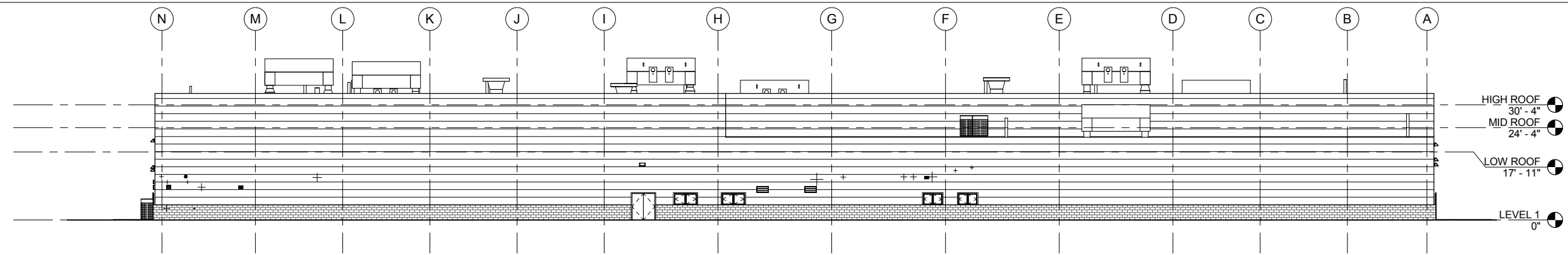

2
VMF - 004
1/16" = 1'-0"
0 8' 16' 32'

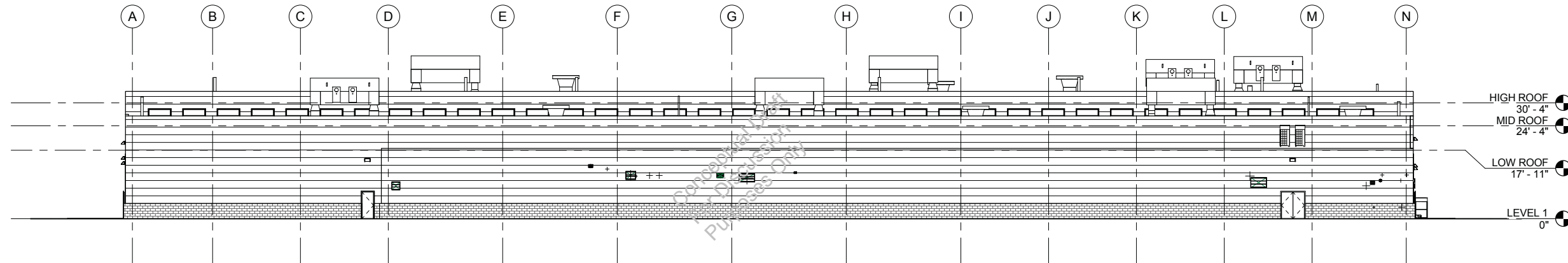

3
VMF - 004
1/16" = 1'-0"
0 8' 16' 32'

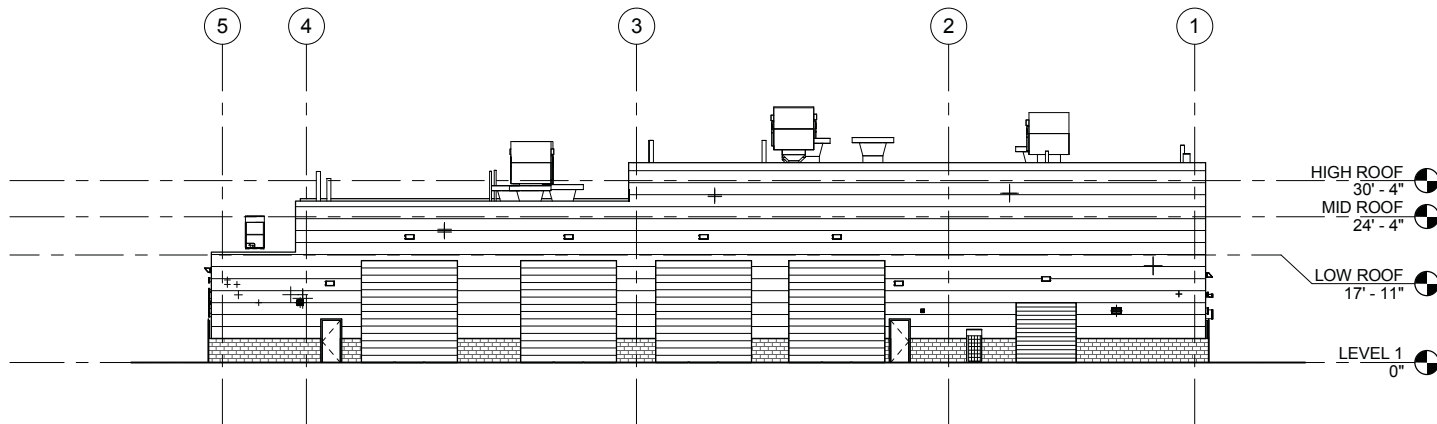

1
VMF - 004
1/16" = 1'-0"
0 8' 16' 32'

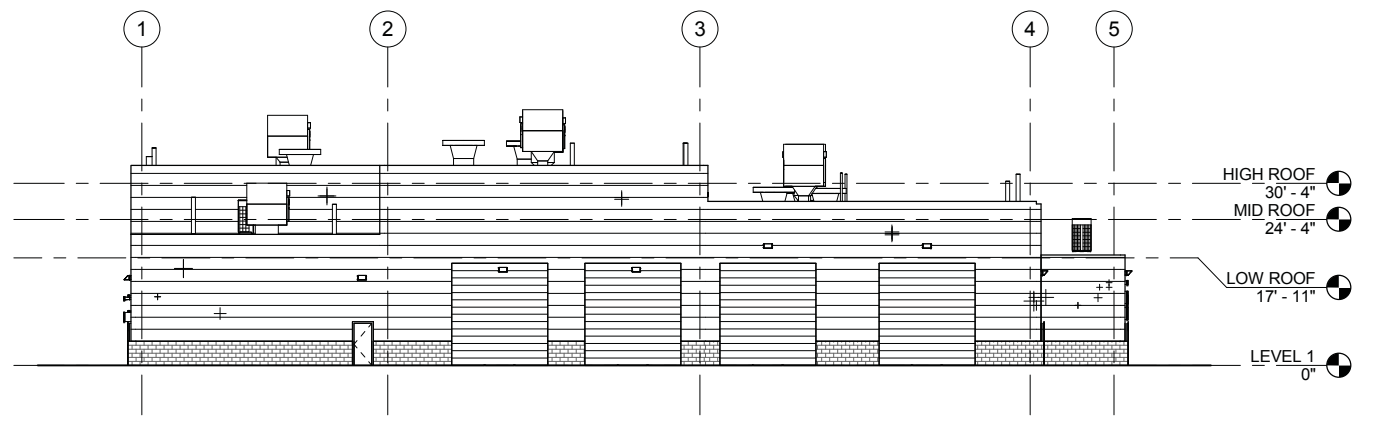

4
VMF - 004
1/16" = 1'-0"
0 8' 16' 32'

Conceptual Draft
For Discussion
Purposes Only

PROPOSAL

MASSACHUSETTS BAY TRANSPORTATION AUTHORITY

T

GREEN LINE EXTENSION PROJECT
MBTA CONTRACT NO. E22CN04
CAMBRIDGE/SOMERVILLE, MASSACHUSETTS

**VEHICLE MAINTENANCE FACILITY
EXTERIOR ELEVATIONS**

			GV20170258-275.pdf
SCALE: AS NOTED	DRAWN BY: SP	DESIGN BY: SP	CHECK BY: ND
DATE: SEPT. 28, 2017	PLAN NO. SHEET: VMF-006		ISSUE
ISSUE	DATE	DESCRIPTION	BY

9/21/2017 1:25:25 PM \\stvgroup.stvinc.com\3\CGP\A\Vol9\Proposals\Green Line Extension\90_CAD Models and Sheets\07_A_Architectural\VMF_A_3D\0000.rvt

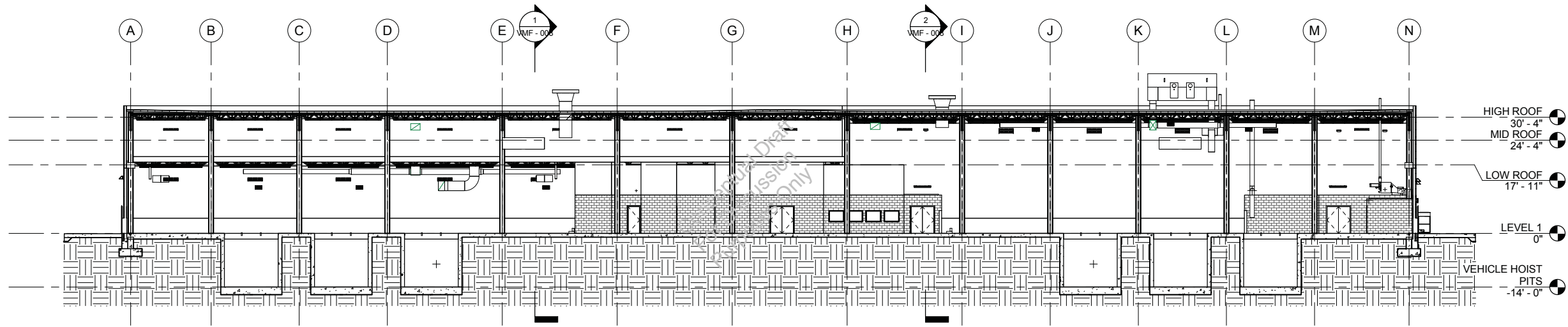

1
VMF-004
1/16" = 1'-0"
0 8' 16' 32'

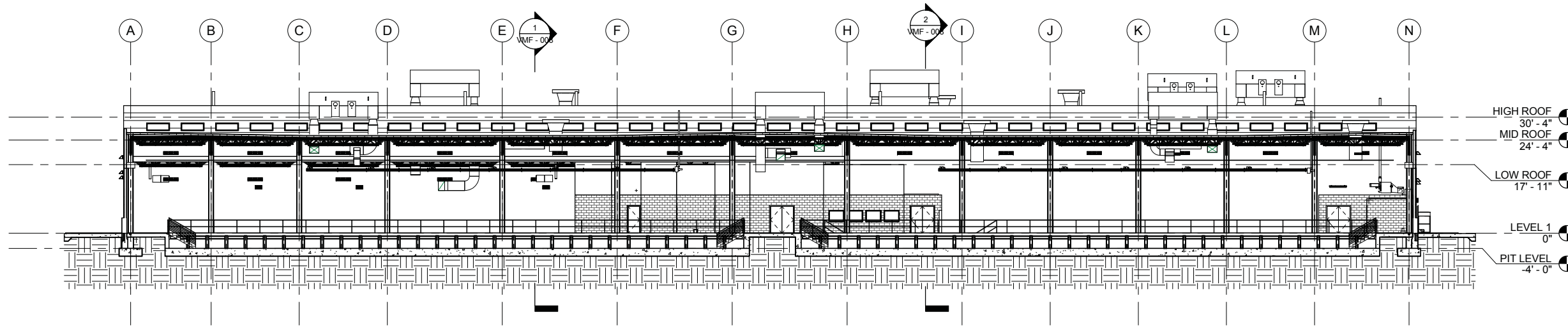

2
VMF-004
1/16" = 1'-0"
0 8' 16' 32'

PROPOSAL

MASSACHUSETTS BAY TRANSPORTATION AUTHORITY



GREEN LINE EXTENSION PROJECT
MBTA CONTRACT NO. E22CN04
CAMBRIDGE/SOMERVILLE, MASSACHUSETTS

**VEHICLE MAINTENANCE FACILITY
BUILDING SECTIONS**



GV20170258-275.pdf

SCALE: AS NOTED	DRAWN BY: SP	DESIGN BY: SP	CHECK BY: ND	PLAN NO.	ISSUE
DATE: SEPT. 28, 2017	BY	CHKD	APP.	SHEET: VMF-007	
ISSUE	DATE	DESCRIPTION	BY	CHKD	APP.

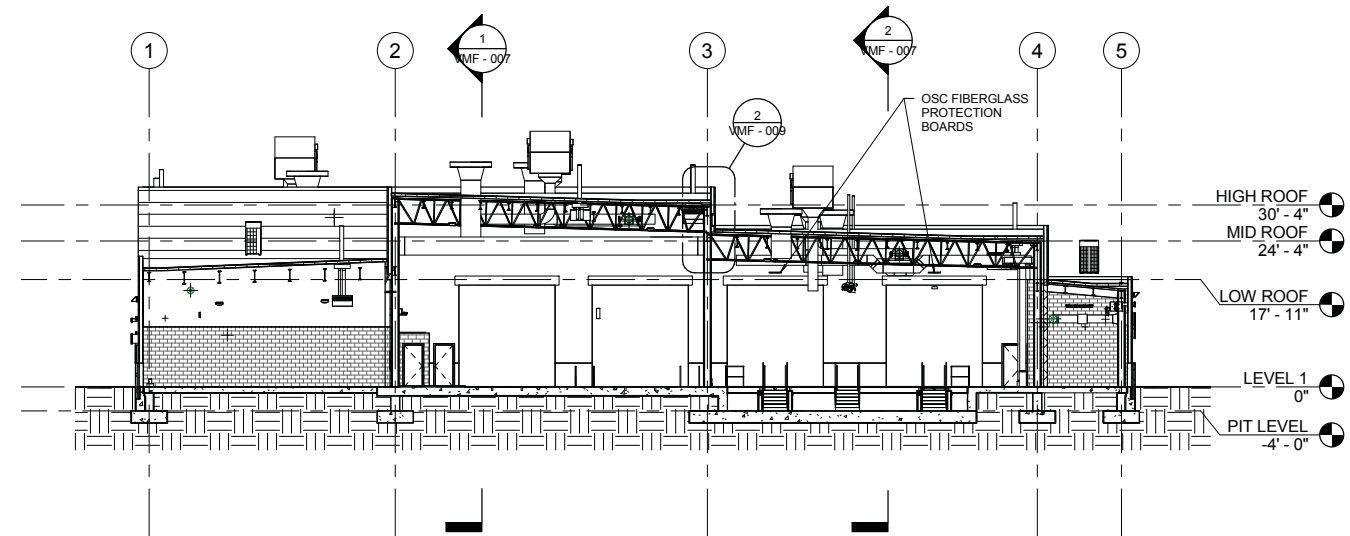

1
VMF-004
1/16" = 1'-0"
0 8' 16' 32'

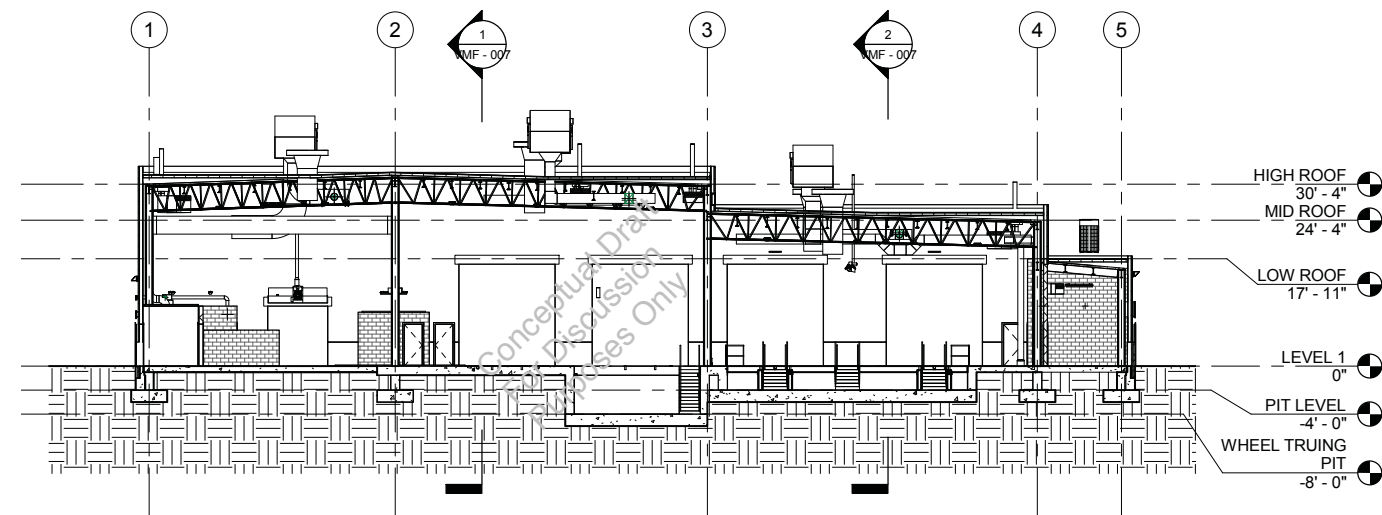

2
VMF-004
1/16" = 1'-0"
0 8' 16' 32'

9/21/2017 1:25:32 PM \\stvgroup.stvinc.com\w\3\CDP\A\Vol9\Proposals\Green Line Extension90_CAD Models and Sheets\07_A_Architectural\VMF_A_3D\0000.rvt

PROPOSAL

MASSACHUSETTS BAY TRANSPORTATION AUTHORITY
GREEN LINE EXTENSION PROJECT
MBTA CONTRACT NO. E22CN04
CAMBRIDGE/SOMERVILLE, MASSACHUSETTS

**VEHICLE MAINTENANCE FACILITY
BUILDING SECTIONS**



GV20170258-275.pdf

SCALE: AS NOTED	DRAWN BY: SP	DESIGN BY: SP	CHECK BY: ND	PLAN NO.	ISSUE
DATE: SEPT. 28, 2017	BY	CHKD	APP.	SHEET: VMF-008	

9/21/2017 1:25:32 PM \\stvgroup.stvinc.com\3DCGPA\Vol9\Proposals\Green Line Extension\90_CAD Models and Sheets\07_A_Architectural\VMF_A_3D0000.rvt

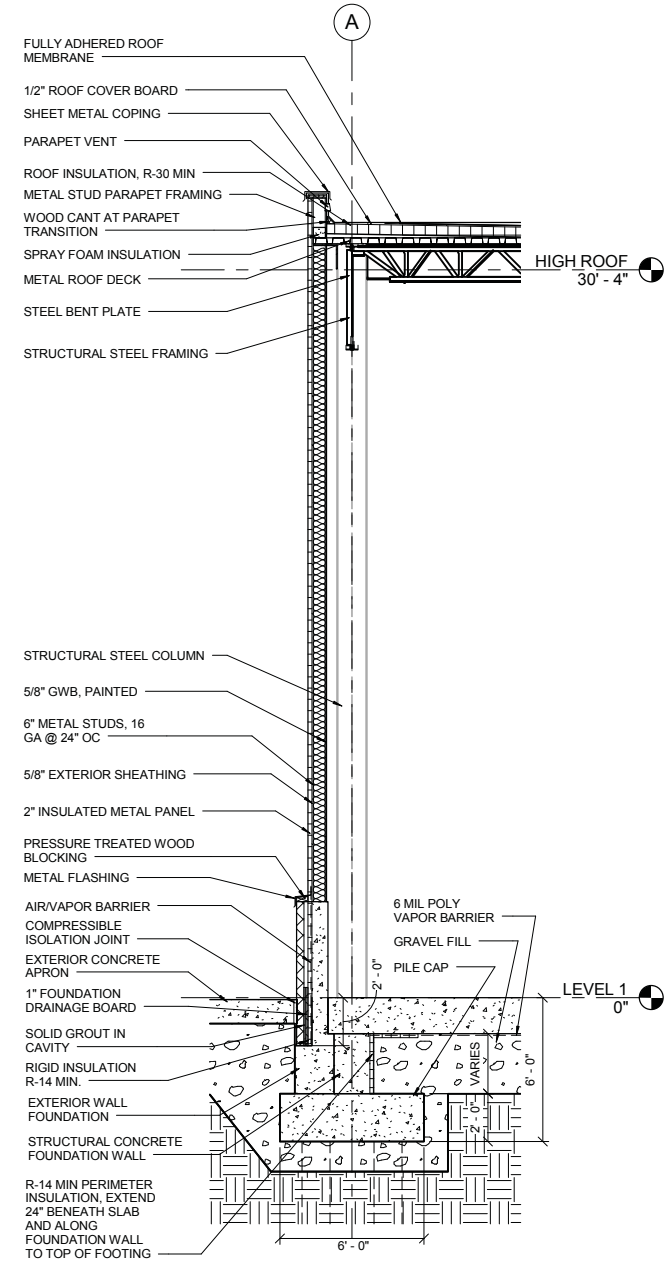

TYPICAL WALL SECTION

1
VMF-004
1/4" = 1'-0"
0 2 4 8

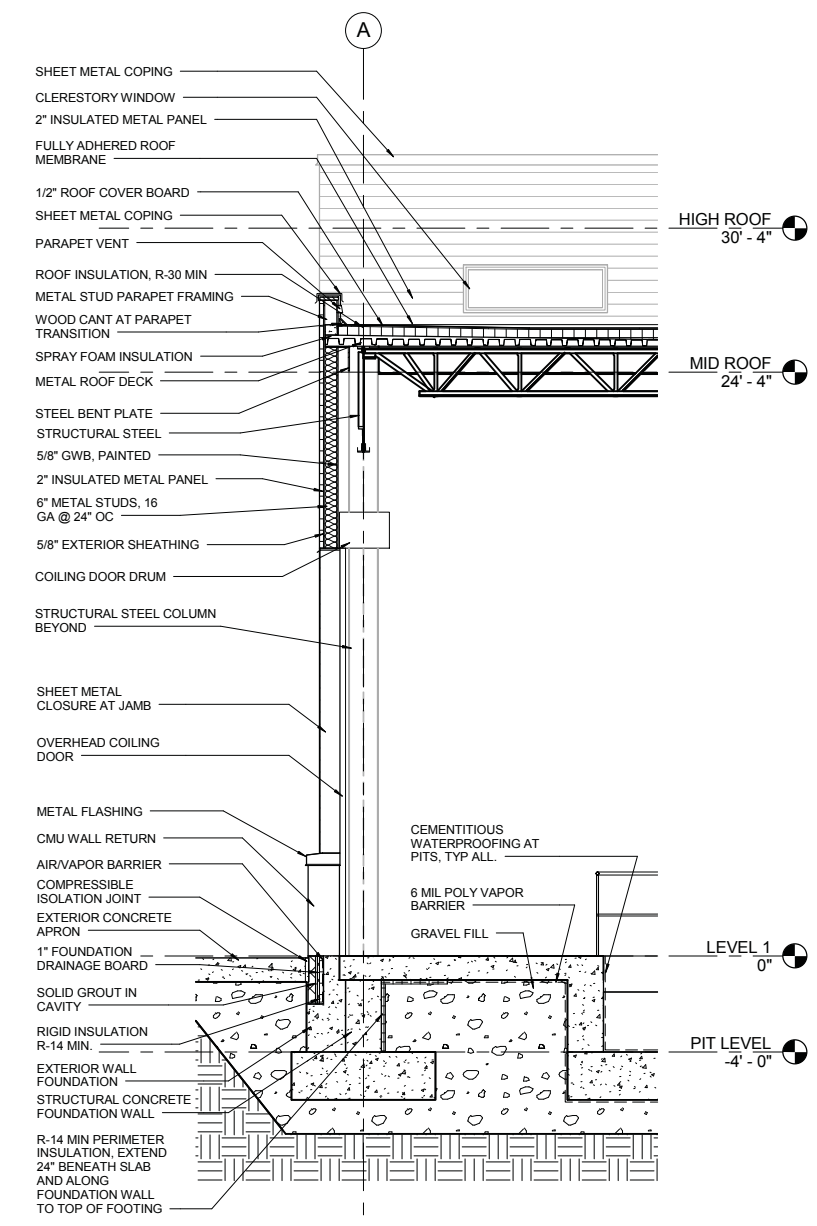

WALL SECTION AT OVERHEAD COILING DOOR

3
VMF-004
1/4" = 1'-0"
0 2 4 8

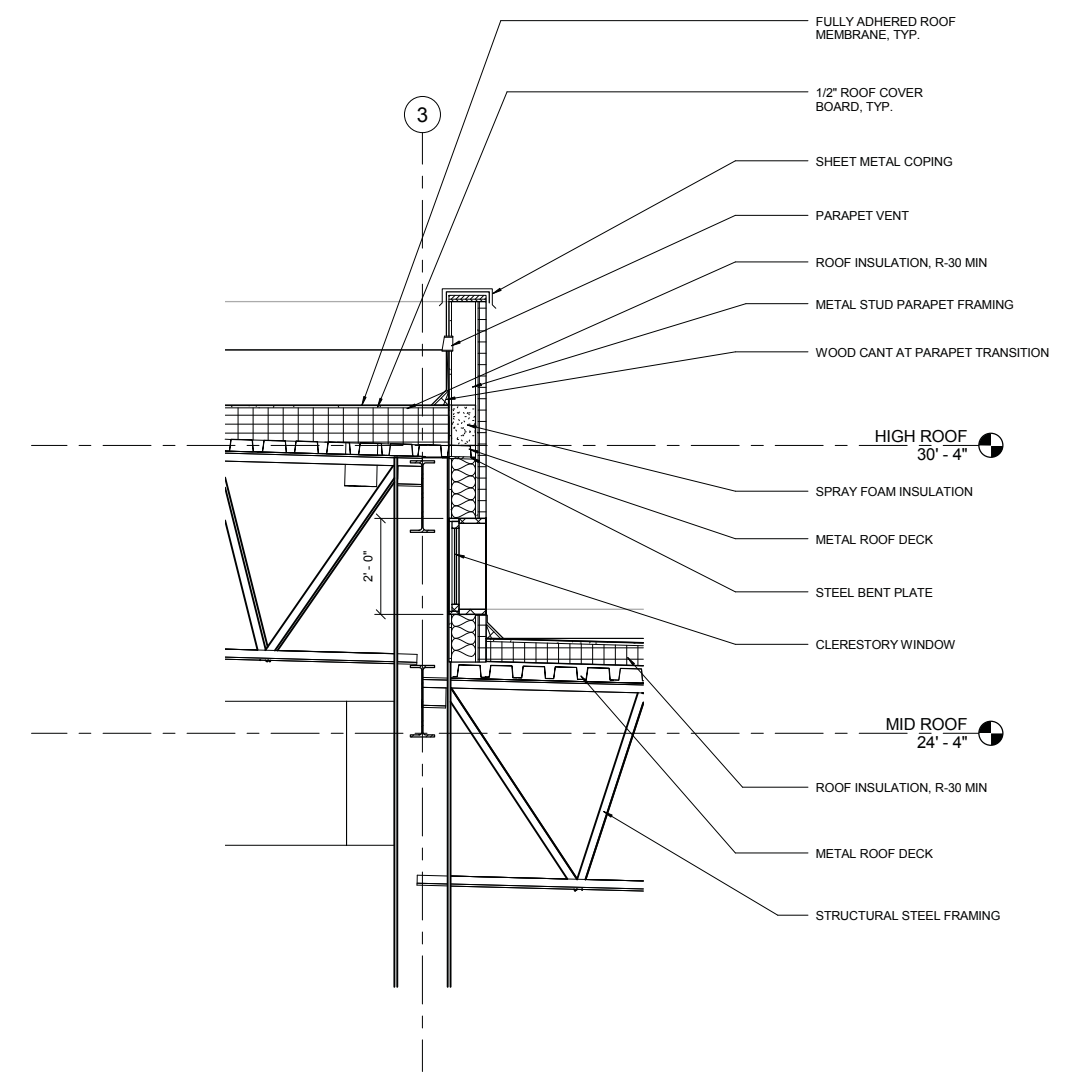

DETAIL AT CLERESTORY

2
VMF-008
1/2" = 1'-0"
0 1 2 4

PROPOSAL

MASSACHUSETTS BAY TRANSPORTATION AUTHORITY
GREEN LINE EXTENSION PROJECT
MBTA CONTRACT NO. E22CN04
CAMBRIDGE/SOMERVILLE, MASSACHUSETTS

VEHICLE MAINTENANCE FACILITY WALL SECTIONS



GV20170258-275.pdf

ISSUE	DATE	DESCRIPTION	BY	CHKD	APP.	SCALE: AS NOTED	DRAWN BY	DESIGN BY	CHECK BY	PLAN NO.	ISSUE
						DATE: SEPT. 28, 2017	SP	SP	ND	SHEET: VMF-009	

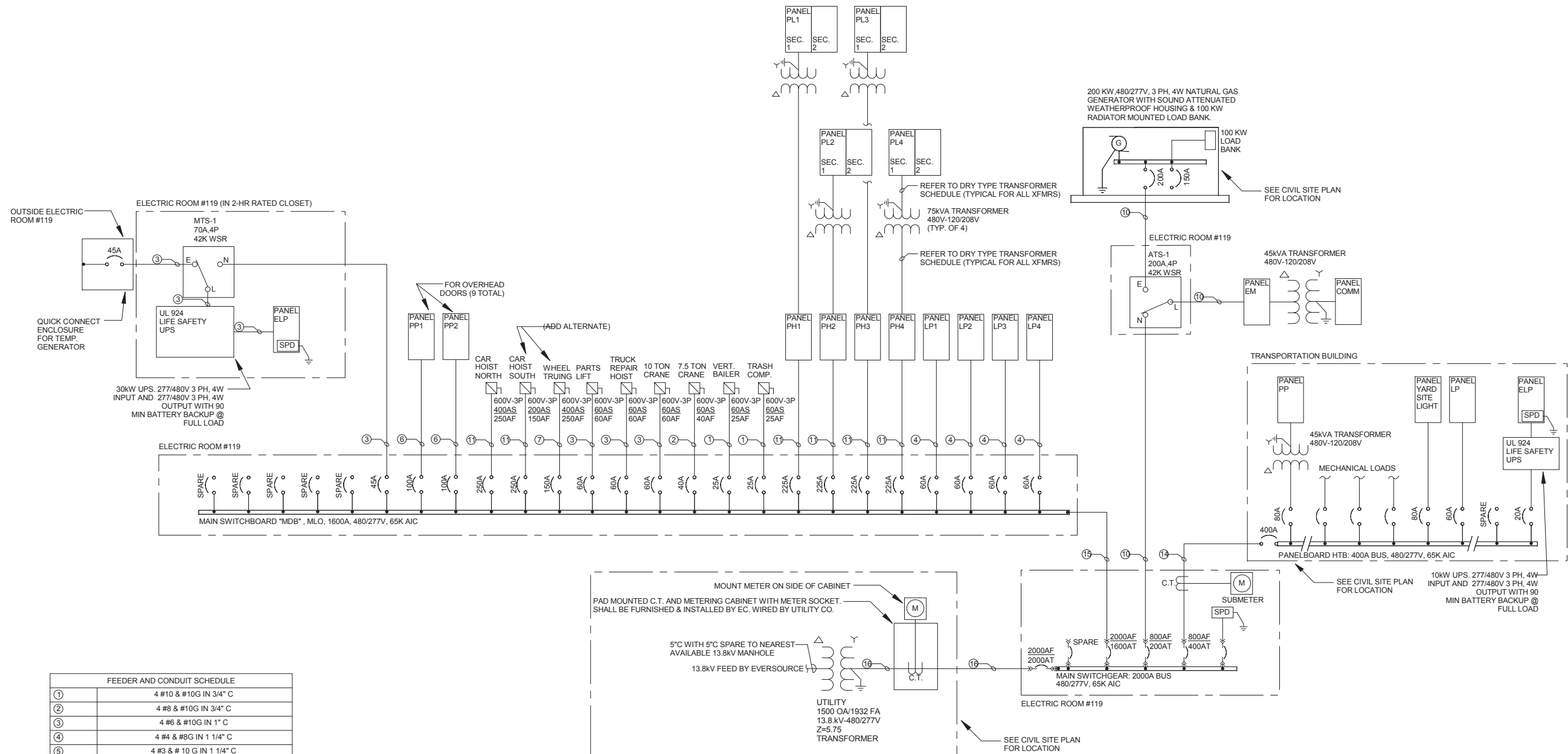

FEEDER AND CONDUIT SCHEDULE	
①	4 #10 & #10G IN 3/4" C
②	4 #8 & #10G IN 3/4" C
③	4 #6 & #10G IN 1" C
④	4 #4 & #8G IN 1 1/4" C
⑤	4 #3 & #10 G IN 1 1/4" C
⑥	4 #1 & #6 G IN 1 1/2" C
⑦	4 #1/0 & #6 G IN 2" C
⑧	4 #2/0 & #6 G IN 2" C
⑨	4 #3/0 & #6 G IN 2" C
⑩	4 #4/0 & #4G IN 4" C WITH (1) 4" C SPARE
⑪	4 #250KCMIL & #4G IN 3" C
⑫	4 #350KCMIL & #4G IN 3" C
⑬	4 #500KCMIL & #3G IN 4" C
⑭	3 SETS OF 4 #600KCMIL & #1G IN (3) 4" C AND 4" C SPARE
⑮	5 SETS OF 4 #400KCMIL & 4/0 G IN (5) 3" C
⑯	6 SETS OF 4 #400KCMIL & 250KCMIL G IN (6) 3" C AND (3) 3" SPARES

DRY TYPE TRANSFORMER SCHEDULE					
SIZE KVA	PRIMARY OVERCURRENT PROTECTION (480V)	SECONDARY OVERCURRENT PROTECTION (208V)	480V PRIMARY FEEDER	120/208V SECONDARY FEEDER	GROUNDING CONDUCTOR, SYSTEM BONDING JUMPER AND EQUIPMENT BONDING JUMPER
45	80A, 3P	150A, 3P	3#1 & 1#8G IN 1 1/4" C	4#1/0 & 1#6G IN 2" C	1#6 IN 3/4" C
75	150A, 3P	250A, 3P	3#2/0 & 1#6 IN 1 1/2" C	4-250 KCMIL & 1#2G IN 3" C	1#2 IN 3/4" C

PROPOSAL

MASSACHUSETTS BAY TRANSPORTATION AUTHORITY

T

GREEN LINE EXTENSION PROJECT
 MBTA CONTRACT NO. E22CN04
 CAMBRIDGE/SOMERVILLE, MASSACHUSETTS

**VEHICLE MAINTENANCE FACILITY
ELECTRICAL ONE-LINE DIAGRAM**

SCALE: NOT TO SCALE	DRAWN BY: SO	DESIGN BY: SO	CHECK BY: ND	PLAN NO.:	ISSUE
DATE: SEPT. 28, 2017	DATE: SEPT. 28, 2017	DATE: SEPT. 28, 2017	DATE: SEPT. 28, 2017	SHEET: VMF-010	

9/21/2017 2:31:35 PM C:\Users\packarsj\Documents\VMF_MEP_300000_packages.rvt

GV20170258-275.pdf

FIRE ALARM SYSTEM NOTES

- CONTRACTOR SHALL REFER TO THE NOTES ON THE FA LEGEND, NOTES PROVIDED ON THIS SHEET, CONTRACT SPECIFICATIONS AND DRAWINGS FOR QUANTITY OF DEVICES, SPARE CAPACITY, TYPE OF DEVICES, WIRING OF DEVICES, ETC.
- SUBMIT AS PART OF SHOP DRAWINGS COMPLETE FLOOR PLANS & RISERS WITH ALL DEVICES SHOWN AND WITH DEVICE ADDRESSES.
- PROGRAMMING OF ADDRESSES SHALL BE COORDINATED WITH THE FIRE DEPARTMENT TO MATCH THE LOCAL FIRE DEPT. LABELING PROTOCOL. DEVICE ADDRESS DESCRIPTIONS TO BE ISSUED TO THE ENGINEER AND FIRE DEPT. FOR APPROVAL PRIOR TO FINAL PROGRAMMING.
- TYPICALLY ALL HORN/STROBE UNITS SHALL BE WIRED SO THAT THE STROBES ARE SYNCHRONIZED WHERE MULTIPLE DEVICES ARE IN THE SAME FIELD OF VIEW PER NFPA 72 AND SO THAT ALL BUILDING HORN/STROBES CAN BE SILENCED SIMULTANEOUSLY.
- ALL DEVICES SHALL BE LABELED WITH CLEAR TAPE WITH BLACK INK, TYPED. LABEL SHALL IDENTIFY LOOP# AND DEVICE NUMBER.
- FIRE ALARM WIRING SHALL BE CLASS A; FAULT ISOLATOR MODULES SHALL BE INSTALLED IN THE FACP TO PROTECT SIGNAL LINE CIRCUITS WHEN THEY LEAVE THE FACP AND WHEN THEY RETURN TO THE FACP. ALSO, FAULT ISOLATOR MODULES WILL BE PROVIDED BETWEEN FLOORS AND/OR FOR EVERY 18 ADDRESSABLE DEVICES.
- FIRE ALARM WIRING TERMINATIONS SHALL BE MADE ON TERMINAL BLOCKS; NO SPLICES ARE ALLOWED. NUMBER OR CIRCUITS TO BE DETERMINED BY THE CONTRACTOR.
- CONTRACTOR SHALL PROVIDE ALL NECESSARY HARDWARE AND SOFTWARE FOR A COMPLETE AND OPERABLE SYSTEM.
- CONTRACTOR SHALL PROVIDE ENOUGH BATTERY CAPACITY FOR THE FIRE ALARM SYSTEM TO OPERATE FOR 80 HOURS IN A NON-ALARM CONDITION AND CAPABLE OF OPERATING IN ALARM FOR 10 MINUTES AT THE END OF THE 60 HOUR PERIOD.
- CONTRACTOR SHALL REFER TO HVAC DRAWINGS FOR EXACT LOCATION OF HVAC UNITS AND FOR LOCATIONS OF DUCT MOUNTED SMOKE DETECTORS. DUCT DETECTORS FURNISHED AND WIRED BY E.C. INSTALLED BY HVAC.
- ALL REMOTE TEST STATIONS SHALL BE KEYED AND MOUNTED ADJACENT TO THE FACP OR AS DIRECTED BY LOCAL FIRE DEPT. LABEL EACH UNIT.
- ALL TAMPER AND SUPERVISORY SWITCHES SHALL BE WIRED AS LOCAL SUPERVISORY ALARM CONDITION UPON ACTIVATION. TROUBLE OR SUPERVISORY SHALL BE SELF RESTORING. TRANSMIT SIGNAL TO CENTRAL STATION, BUT DO NOT ALARM BUILDING.
- ALL FLOW SWITCHES SHALL BE CONNECTED AS ALARM CIRCUIT TO GENERATE A GENERAL ALARM ON THE SYSTEM.
- CONTROL MODULES SERVING MECHANICAL EQUIPMENT, MOTORIZED FIRE/SMOKE DAMPERS AND OTHER EMERGENCY FUNCTIONS SHALL BE LOCATED WITHIN 3 FEET OF THE CONTROLLED CIRCUIT OR APPLIANCE.
- ELECTRICALLY HELD DOOR LOCKS ALONG THE PATH OF EGRESS SHALL BE CONNECTED TO THE FIRE ALARM SYSTEM VIA A CONTROL MODULE AND INTERFACE RELAY. DEVICE SHALL BE PROGRAMMED TO DROP OUT IN THE CASE OF A GENERAL ALARM TO FAIL OPEN THE LOCK. REFER TO ARCHITECTURAL AND SECURITY PLANS FOR DOORS WITH ELECTRICALLY HELD LOCKS.
- FIRE AND SMOKE DOORS MAGNETICALLY HELD OPEN SHALL BE CONNECTED TO THE FIRE ALARM SYSTEM VIA A CONTROL MODULE AND INTERFACE RELAY. DEVICE SHALL BE PROGRAMMED TO DROP OUT IN THE CASE OF A GENERAL ALARM TO SHUT THE DOOR. REFER TO ARCHITECTURAL AND SECURITY PLANS FOR DOORS WITH HOLDERS

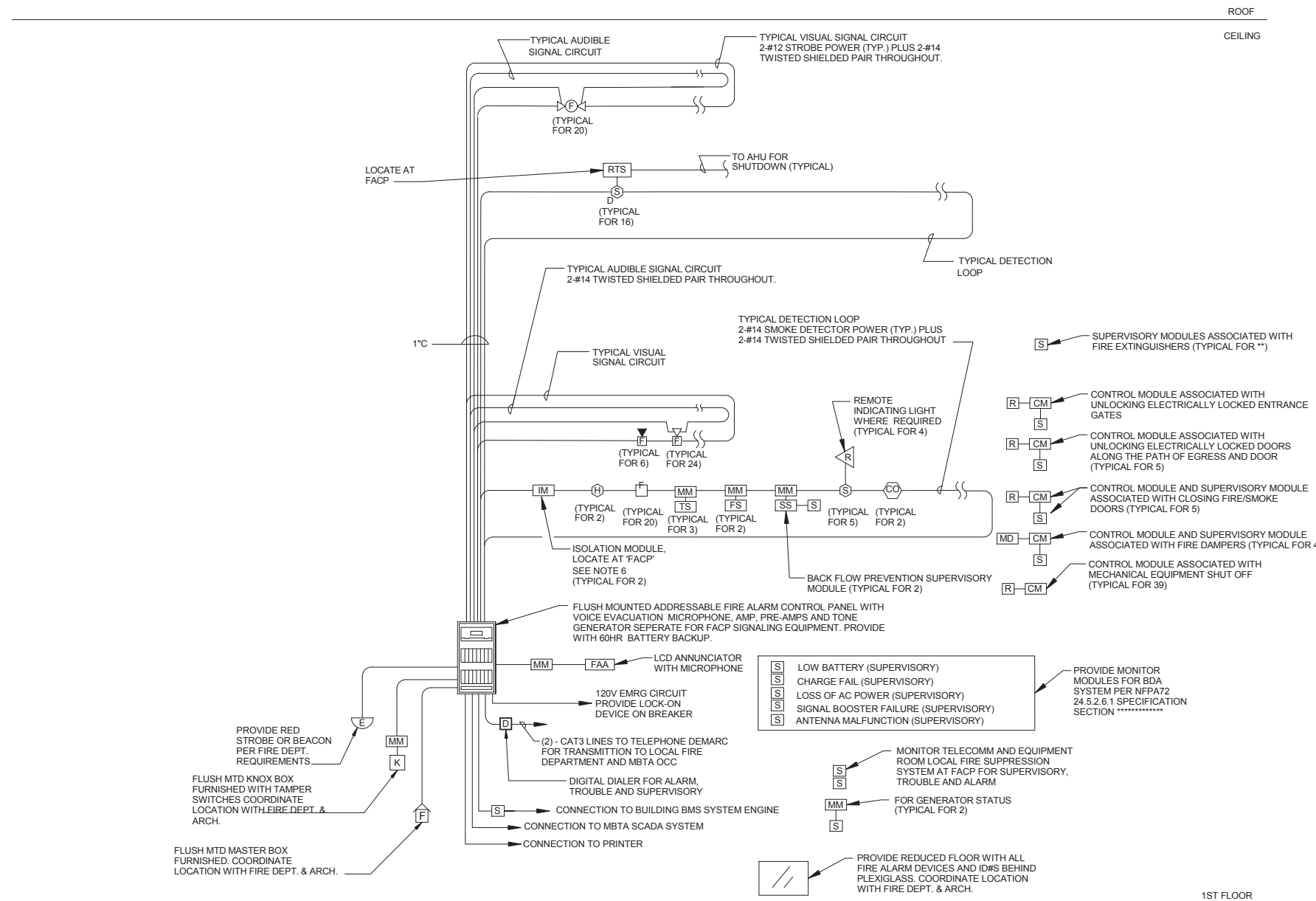

1 FIRE ALARM RISER DIAGRAM
SCALE: NTS

PROPOSAL

MASSACHUSETTS BAY TRANSPORTATION AUTHORITY
GREEN LINE EXTENSION PROJECT
MBTA CONTRACT NO. E22CN04
CAMBRIDGE/SOMERVILLE, MASSACHUSETTS

**VEHICLE MAINTENANCE FACILITY
ELECTRICAL ONE-LINE DIAGRAM**



GV20170258-275.pdf

SCALE: NOT TO SCALE	DRAWN BY: RF	DESIGN BY: RF	CHECK BY: ND	PLAN NO.	ISSUE
DATE: SEPT. 28, 2017	DATE: SEPT. 28, 2017	DATE: SEPT. 28, 2017	DATE: SEPT. 28, 2017	SHEET: VMF-011	
ISSUE	DATE	DESCRIPTION	BY	CHKD	APP.

MECHANICAL GENERAL NOTES

1. STORAGE 101 & SERVICE FLOOR 125: HEATING AND VENTILATION PROVIDED BY ROOF MOUNTED AHU-1 THRU 8 TO MAINTAIN SPACE SETPOINT (ADJ.). SUMMER VENTILATION PROVIDED BY ROOF MOUNTED EXHAUST FANS SEF-1 THRU 6. VENTILATION MAKEUP AIR VIA OPEN TRAIN DOORS AND ADJACENT SPACES. SUPPLEMENTAL SPACE HEATING PROVIDED BY SPACE GAS-FIRED UNIT HEATERS. ALL EQUIPMENT SERVED BY SPACE AVERAGING TEMPERATURE SENSORS. REFER TO PLAN FOR ADDITIONAL INFORMATION.

2. TRUCK WASH 113: DETAILS TO BE PROVIDED.

3. SPACE CO & NOx: COMBINATION CO & NOx DETECTORS (PPM ADJ.) SHALL BE LOCATED THROUGHOUT STORAGE 101, SERVICE FLOOR 125, TRUCK WASH 113, AND OTHER SPACES CONTAINING FUEL BURNING EQUIPMENT. DETECTORS SHALL BE LOCATED AT WALL PERIMETER AND ON COLUMNS 4 A.F.F. INTERLOCK DETECTION SIGNAL WITH AUDIBLE STROBE/ALARM AND SEF-1 THRU 6 AND AHU-1 THRU 8 OPERATION.

4. FIRE DAMPERS, SMOKE DAMPERS, AND COMBINATION FIRE/SMOKE DAMPERS SHALL BE PROVIDED AT ALL DUCT PENETRATIONS OF FIRE, SMOKE, AND FIRE/SMOKE BARRIERS WHERE REQUIRED. PROVIDE DUCT SMOKE DETECTORS AS REQUIRED.

MECHANICAL NEW WORK NOTES

- 1. ROUTE EXHAUST FLUE AND COMBUSTION AIR INTAKE UP FROM UNIT HEATER(S). CONNECT TO CONCENTRIC VENT KIT AT ROOF LINE. REFER TO MANUFACTURER'S RECOMMENDATIONS FOR FINAL ROUTING AND FLUE SIZING.
- 2. 14"Ø PIT EXHAUST, BALANCE TO 1500 CFM (TYP.)
- 3. ROUTE PVC CONDENSATE DRAINS, APPROPRIATELY SIZED AND PITCHED, FROM ALL HIGH EFFICIENCY GAS BURNING EQUIPMENT TO CONDENSATE NEUTRALIZER BASINS. PUMP POST-NEUTRALIZED CONDENSATE TO NEAREST FLOORDRAIN. PROVIDE DRAIN ANTI-TRIP DEVICES AT ALL PATH OF TRAVEL DRAIN CROSSINGS. PROVIDE PROTECTIVE BOLLARDS AS NECESSARY TO SHIELD NEUTRALIZER BASINS FROM DAMAGE.
- 4. AHU RETURN AIR: 50% OF TOTAL CFM SHALL BE VIA LOW RETURN AND 50% OF TOTAL CFM SHALL BE VIA HIGH RETURN.
- 5. RETURN AIR SHALL BE VIA HIGH RETURN
- 6. WELDING SPOT CAPTURE EQUIPMENT PROVIDED BY INDUSTRIAL ENGINEERING. REFER TO MANUFACTURER'S RECOMMENDATIONS FOR EXHAUST MATERIAL, ROUTING, AND SIZING, AS REQUIRED.
- 7. PROVIDE 420 CFM OF EXHAUST IN THE WHEEL TRUING PIT. EXHAUST CFM SHALL BE PROVIDED BY ROOF TOP AHU'S.

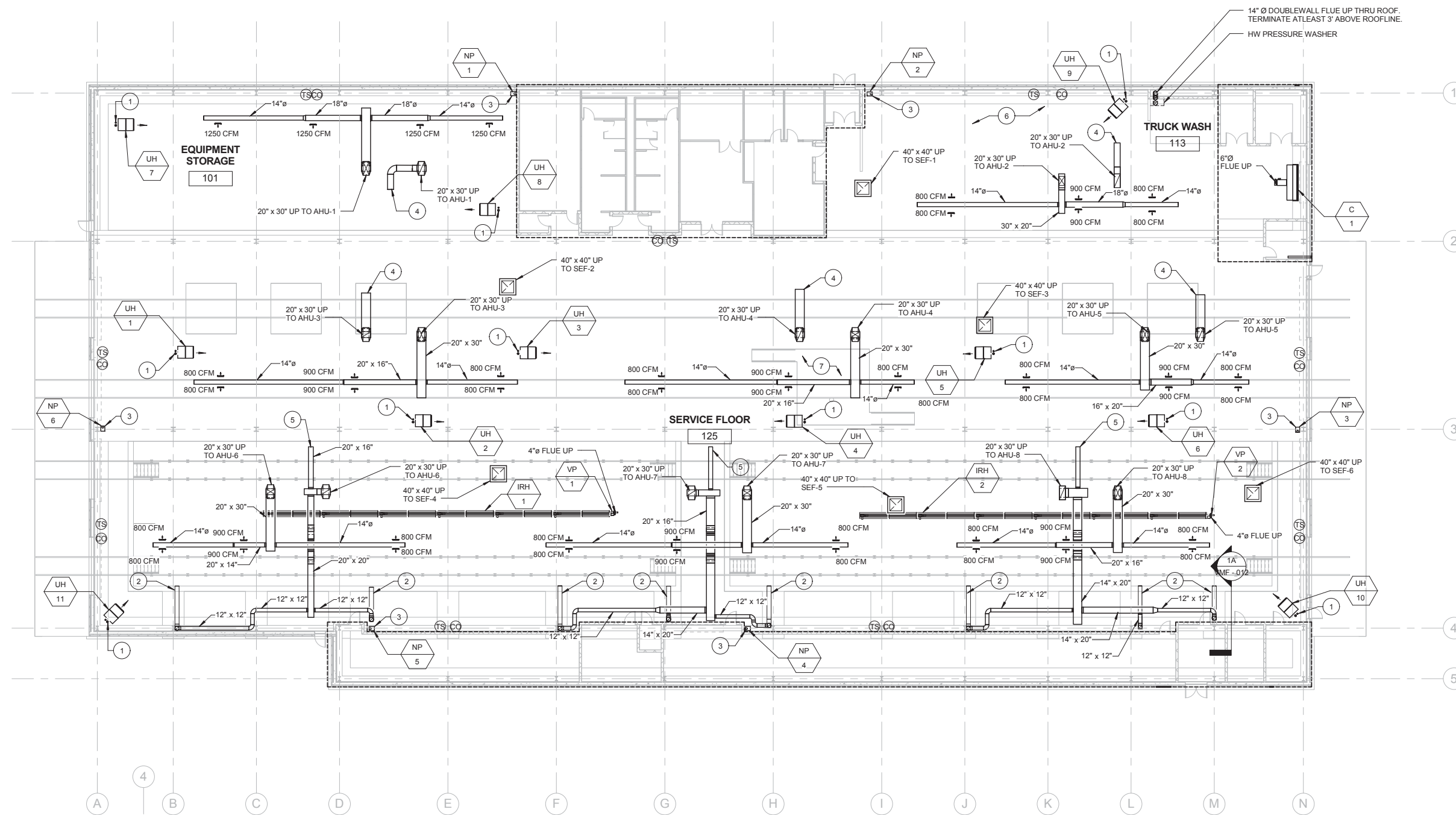

OVERALL VMF WORK PLAN

1/16" = 1'-0" 0 8' 16' 32'

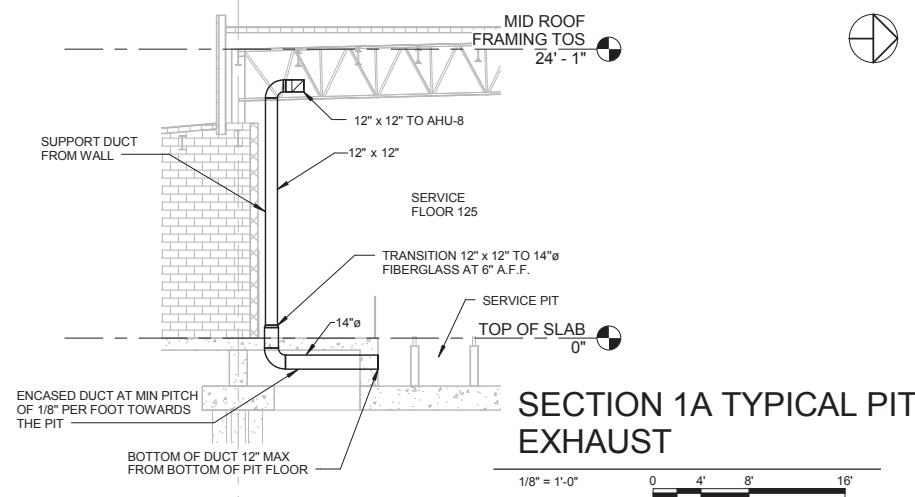

SECTION 1A TYPICAL PIT EXHAUST

1/8" = 1'-0" 0 4' 8' 16'

PROPOSAL

MASSACHUSETTS BAY TRANSPORTATION AUTHORITY
GREEN LINE EXTENSION PROJECT
 MBTA CONTRACT NO. E22CN04
 CAMBRIDGE/SOMERVILLE, MASSACHUSETTS

**VEHICLE MAINTENANCE FACILITY
 MECHANICAL OVERALL WORK PLAN**



GV20170258-275.pdf

SCALE: AS NOTED	DRAWN BY: KJM	DESIGN BY: CPD	CHECK BY: ND	PLAN NO.	ISSUE
DATE: SEPT. 28, 2017				SHEET: VMF-012	
ISSUE	DATE	DESCRIPTION	BY	CHKD	APP.

9/21/2017 2:31:40 PM C:\Users\packarsj\Documents\VMF_ME_P_300000_packages.rvt

MECHANICAL GENERAL NOTES

1. ALL MECHANICAL EQUIPMENT SHALL LOCATED ATLEAST 10' FROM EDGE OF ROOF.
2. ALL MECHANICAL EXHAUST OUTLETS SHALL BE LOCATED ATLEAST 25' FROM AHU INTAKES.

MECHANICAL NEW WORK NOTES

1. 20" x 30" SUPPLY AIR AND RETURN AIR DUCT DN THRU ROOF. (TYP. FOR AHU-1 THRU 8).
2. 40" x 40" EXHAUST AIR DUCT DN THRU ROOF. (TYP. FOR SEF-1 THRU 6).

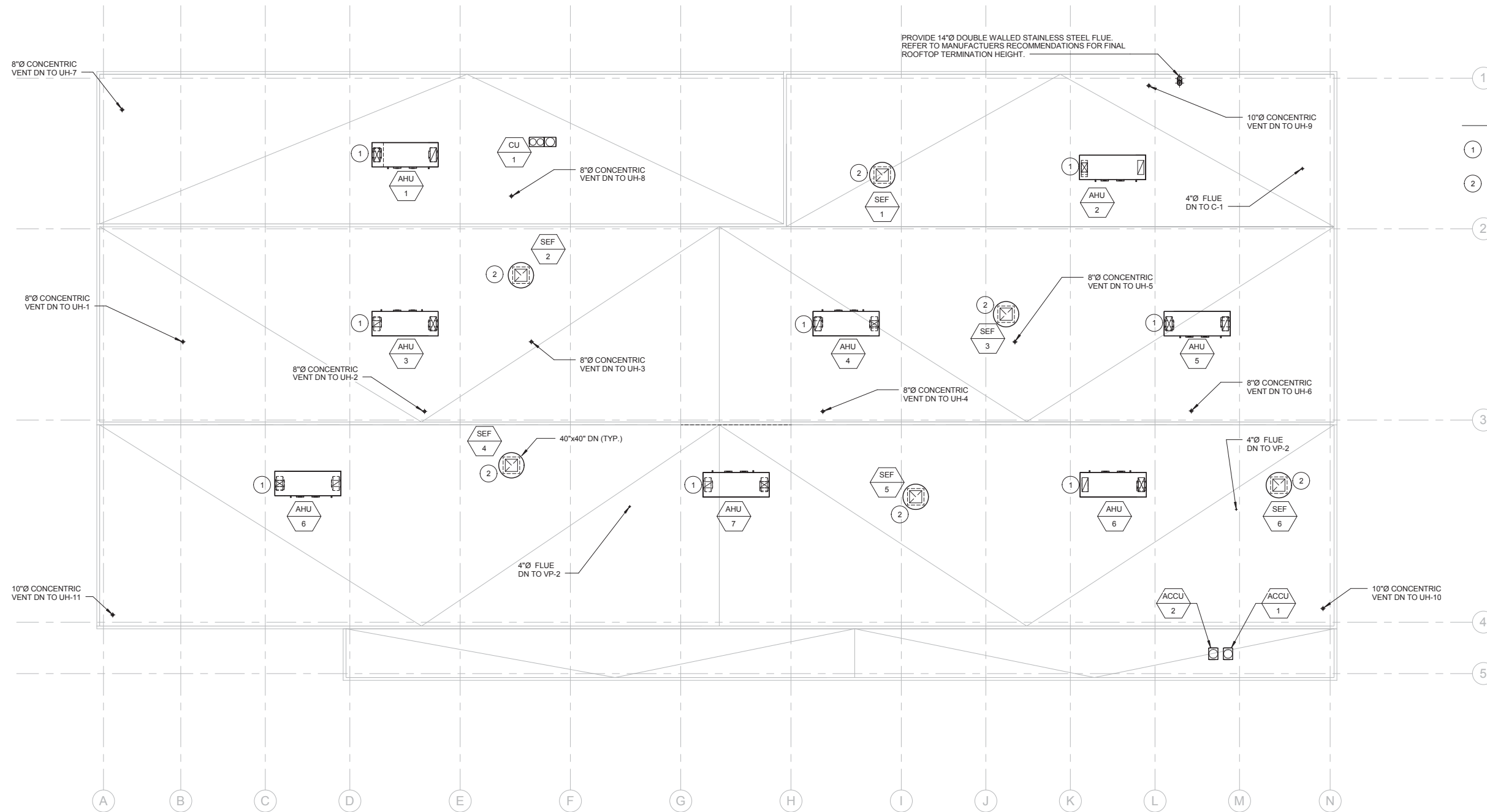

PROPOSAL

MASSACHUSETTS BAY TRANSPORTATION AUTHORITY



GREEN LINE EXTENSION PROJECT
 MBTA CONTRACT NO. E22CN04
 CAMBRIDGE/SOMERVILLE, MASSACHUSETTS

**VEHICLE MAINTENANCE FACILITY
 MECHANICAL ROOF PLAN**



GV20170258-275.pdf

SCALE: AS NOTED	DRAWN BY: KJM	DESIGN BY: CPD	CHECK BY:	PLAN NO.	ISSUE
DATE: SEPT. 28, 2017				SHEET: VMF-013	

HEATING AND VENTILATOR WITH PLATE AND FRAME ENERGY RECOVERY SCHEDULE

SYMBOL	BASIS OF DESIGN	AREA SERVED	LOCATION	EXHAUST FAN								SUPPLY FAN								NATURAL GAS HEATING				AIR-TO-AIR "PLATE-TYPE" HEAT EXCHANGER					VOLTS / PH / HZ	FLA	MOP	WEIGHT (LB)	FILTER	REMARKS		
				TOTAL CFM	MIN. CFM	QTY.	ESP	RPM	BHP	MOTOR HP	MOTOR RPM	TOTAL CFM	MIN. CFM	QTY.	ESP	RPM	BHP	MOTOR HP	MOTOR RPM	INPUT MBH	OUTPUT MBH	MIN. BURNER EFF.	GAS (IN WG)	EAT (°F)	LAT (°F)	EXHAUST - EAT (DB°F)	EXHAUST - LAT (DB°F)	SUPPLY - EAT (DB°F)							SUPPLY - LAT (DB°F)	MIN EFF % (SENS. / TOTAL)
AHU-1,2,3,4,5,6,7,8	JCI (YORK)	VMF	ROOF	5,000	2,500	1	1.5	1357	1.82	5	1725	5,000	4,500	1	1.5	1357	1.82	5	1725	435	405	93	5" - 10"	15.3	80	65	34	7	46	68 / 49	460 / 3 / 60	-	-	8,220	2" MERV 8	ALL

REMARKS:
 1. PROVIDE FUSED DISCONNECT SWITCH (SINGLE POINT POWER CONNECTION FOR UNIT) UNIT MOUNTED CONVENIENCE RECEPTACLE, AND UNIT MOUNTED LIGHTING POWERED BY SEPARATE ELECTRICAL CIRCUIT. COORDINATE WITH EC.
 2. PROVIDE WITH VFD FOR FAN CONTROL FOR ALL FANS
 3. PROVIDE WITH HEAT TRACING AT 5 WATTS PER LINEAR FOOT FOR CONDENSATE LINES INSIDE BURNER HOUSING AND BETWEEN BURNER HOUSING AND BELOW ROOF LEVEL. INSULATE CONDENSATE PIPING OUTSIDE OF BURNER HOUSING AND WHERE REQUIRED BY MANUFACTURER.
 4. PROVIDE WITH RAINHOOD AND BIRD SCREEN FOR ALL INTAKE AND EXHAUST OPENINGS
 5. INSTALL PER MANUFACTURER'S INSTALLATION INSTRUCTIONS
 6. PROVIDE DUCT SMOKE DETECTORS IN THE SUPPLY AND RETURN DUCTWORK, TO BE WIRED BY ELECTRICAL
 7. NATIONALLY RECOGNIZED TESTING LABORATORY (NRTL) CERTIFIED TO UL #1995
 8. PROVIDE WITH ENERGY RECOVERY BYPASS, PROVIDE WITH DUCT MOUNTED SOUND ATTENUATORS ON SUPPLY AND RETURN DUCT MAINS EXTERNAL TO UNIT.
 9. PROVIDE WITH CONDENSATE NEUTRALIZER KIT.

ENERGY RECOVERY VENTILATOR SCHEDULE

SYMBOL	MAKE / MODEL	ROOM(S) SERVING	TYPE	SUPPLY & EXHAUST FAN DATA										WINTER DATA				SUMMER DATA				WEIGHT (LBS)	REMARKS				
				SUPPLY AIR FLOW (CFM)		EXHAUST AIR FLOW (CFM)		ESP (IN WG)		FAN SPEED		RPM		MOTOR ELECTRICAL DATA				OA EAT (DBWB)(°F)		RA EAT (DBWB)(°F)				SA EAT (DBWB)(°F)		ENERGY TRANSFER (BTU)	
				QTY.	FLA	MCA	MOP	VOLTS/PH/Hz	OA EAT (DBWB)(°F)	RA EAT (DBWB)(°F)	SA EAT (DBWB)(°F)	ENERGY TRANSFER (BTU)															
ERV-1	RENEWAIRE / HE1.5XINH	104 TO 112	STATIC PLATE, ENTHALPY CORE	1048	1048	1	VAR.	VAR.	2	1.1	2.5	15	480 / 3 / 60	7.4 / 0	70	38.7	-	90.8 / 73.3	75 / 62	97.4	-	464	1,2,3,4				
ERV-2 / ERV-5	RENEWAIRE / BR70	115,116 / 117	STATIC PLATE, ENTHALPY CORE	50	50	0.35	VAR.	VAR.	1	1	-	-	120 / 1 / 60	7.4 / 0	55	31.2	-	90.8 / 73.3	104	97.4	-	38	1,2,3,4				
ERV-3	RENEWAIRE / 450IN	121	STATIC PLATE, ENTHALPY CORE	250	250	1	VAR.	VAR.	1	0.8	1	15	480 / 3 / 60	7.4 / 0	55	31.2	-	90.8 / 73.3	104	97.4	-	199	1,2,3,4				
ERV-4	RENEWAIRE / EV200	122,123,124	STATIC PLATE, ENTHALPY CORE	175	175	0.4	VAR.	VAR.	1	1.5	-	-	120 / 1 / 60	7.4 / 0	55	31.2	-	90.8 / 73.3	104	97.4	-	68	1,2,3,4				

REMARKS:
 1. PROVIDE WITH NON-FUSED DISCONNECT AND ONBOARD 24 VAC POWER
 2. PROVIDE WITH SEISMIC RESTRAINTS AND VIBRATION ISOLATORS
 3. PROVIDE WITH MERV 8, 2" PLEATED FILTERS FOR BOTH SUPPLY AND EXHAUST
 4. PROVIDE ELECTRIC HEATING COIL ON OA DUCT, REFER TO ELECTRIC HEATING COIL SCHEDULE.

CONDENSATE BASIN

SYMBOL	MAKE / MODEL	MAX FLOW (GAL/HR)	PUMP ELECTRICAL (V/PH/Hz)	WEIGHT (LBS)	REMARKS
NP-(1 THROUGH 6)	AXIOM NT25-P	40	120 / 1 / 60	55	ALL

REMARKS:
 1. PROVIDE WITH REPLACEMENT LIPHTER NEUTRALIZATION MEDIA, 1 KIT PER BASIN. PROVIDE POST-NEUTRALIZER COND. PUMP

ELECTRIC BASEBOARD

SYMBOL	MAKE / MODEL	WATT / LF.	LENGTH (FT.)	PUMP ELECTRICAL (V/PH/Hz)	WEIGHT (LBS)	REMARKS
EB	BERKO / 25008	312.5	SEE PLANS	277 / 1 / 60	18.5	ALL

REMARKS:
 1. PROVIDE DISCONNECT SWITCH. CONTROL WIRING BY MC, POWER WIRING BY EC.

UNIT HEATER / CABINET UNIT HEATER SCHEDULE

SYMBOL	MAKE / MODEL	TYPE	AIRFLOW (CFM)	HEATING SECTION				ELECTRICAL DATA				WEIGHT (LBS)	REMARKS			
				FUEL TYPE	MIN GAS PRESSURE (IN. W.G)	MAX GAS PRESSURE (IN. W.G)	INPUT (MBH)	OUTPUT (MBH)	OUTPUT (KW)	VOLTS / PH / HZ	MOP			FLA	FAN (HP / W)	
UH-1,2,3,4,5,6,7,8	REZNOR / UEAS	INDIRECT	2256	GAS	9	14	131	121.8	-	-	120 / 1 / 60	15	3.8	0.25 HP	230	1,2,3,4,5,6,7
UH-9,10,11	REZNOR / UEAS	INDIRECT	4430	GAS	9	14	260	239.2	-	-	120 / 1 / 60	15	3.8	0.5 HP	360	1,2,3,4,5,6,7
UH-12,13,14,15,16	QMARK / IUH	ELECTRIC	270	-	-	-	-	-	7.5	460 / 3 / 60	-	7.2	6 W	26	2,4,5,7	
UH-17,18,19,20	QMARK / IUH	ELECTRIC	1000	-	-	-	-	-	20	460 / 3 / 60	-	19.3	1 / 10 HP	78	2,4,5,7	
CUH-1	QMARK / IUH	ELECTRIC	1800	-	-	-	-	-	30	460 / 3 / 60	-	36.9	1 / 3 HP	140	4,5,7	

REMARKS:
 1. PROVIDE MANUFACTURERS OPTIONAL 50-90 DEGREE DOWN TURN NOZZLE
 2. PROVIDE NON-FUSED DISCONNECT. CONTROL WIRING BY MECH. POWER CONNECTION BY ELECTRICAL.
 3. PROVIDE VERTICAL COMBUSTION AIR/ VENT KIT INCLUDING CONCENTRIC ADAPTOR.
 4. PROVIDE WITH GALVANIZED AIRCRAFT CABLES, MIN. 1/8" (QUANTITY FOUR) PER UNIT.
 5. PROVIDE WITH MANUFACTURER INTEGRAL CONTROLS, TRANSFORMER FOR 24V CONTROLS, BACNET CONNECTION.
 6. PROVIDE WITH AIR DESTRATIFICATION FAN CONTROL
 7. INSTALL PER MANUFACTURERS INSTALLATION INSTRUCTIONS.

OUTDOOR - SPLIT CONDENSER UNIT SCHEDULE

SYMBOL	MAKE	MODEL	SERVING	LOCATION	NOMINAL COOLING CAPACITY (TONS)	COOLING RATED CAPACITY @95°F (BTU)	HEATING RATED CAPACITY (BTU)	SEER	REFRIGERANT	AMBIENT AIR TEMP (°F)	ELECTRICAL			WEIGHT	REMARKS
											VOLTS / PH / HZ	MCA	MOP		
CU-1	YORK - VRF	HYVAHP	VMF - AREA A	VMF - LOW ROOF	24	288,000	324,000	-	R-410A	95	480 / 3 / 60	-	-	-	ALL
CU-2	YORK - VRF	DHR	SHOP OFFICE 117	SHOP OFFICE 117 ROOF	2	24,000	28,000	-	R-410A	95	208 / 1 / 60	-	-	-	ALL
ACCU-1	YORK	DCP	TELECOM 119	TELECOM 119 ROOF	3	36,000	N/A	-	R-410A	95	208 / 1 / 60	-	-	-	ALL
ACCU-2	YORK	DCP	ELECTRICAL 120	ELECTRICAL 120 ROOF	3	36,000	N/A	-	R-410A	95	208 / 1 / 60	-	-	-	ALL

REMARKS:
 1. PROVIDE WITH DISCONNECT SWITCH.
 2. INSTALL PER MANUFACTURER'S INSTALLATION INSTRUCTIONS.
 3. PROVIDE WITH WIND BAFFLES.
 4. PROVIDE LOW AMBIENT KIT.

FAN SCHEDULE

SYMBOL	BASIS OF DESIGN	MODEL	TYPE	LOCATION	AREA SERVED	CFM	DRIVE	MOTOR HP	MOTOR BHP	EXTERNAL STATIC PRESSURE (IN WC)	FAN RPM	VOLTS / PH / HZ	WEIGHT (LBS)	REMARKS
SEF-(1 THROUGH 6)	GREENHECK	GB-500-100	CENTRIFUGAL	ROOF	SERVICE FLOOR	30,000	BELT	10	-	0.5	442	460 / 3 / 60	580	1,4,8,9,10
EF-1	GREENHECK	SQ-85	INLINE	ROOM 116	ROOM 116, 115	475	DIRECT	1/10	-	0.25	1725	120 / 1 / 60	49	1,4,5,6,11
EF-2	GREENHECK	SQ-120	INLINE	ROOM 124	ROOM 124, 123, 122	1,615	DIRECT	1/2	-	0.25	1725	120 / 1 / 60	63	1,4,5,6,11
EF-3	GREENHECK	SQ-140	INLINE	ROOM 121	ROOM 121	2,595	DIRECT	1	-	0.25	1725	460 / 3 / 60	103	1,4,5,6,11
EF-4	GREENHECK	SQ-70	INLINE	ROOM 118	ROOM 118	244	DIRECT	1/10	-	0.25	1725	120 / 1 / 60	34	1,4,5,6,11

REMARKS:
 1. INSTALL PER MANUFACTURER'S INSTALLATION INSTRUCTIONS
 2. PROVIDE WITH 18" HIGH ROOF CURB AND BIRDSCREEN.
 3. PROVIDE WITH TEFC MOTOR OUTSIDE OF AIR STREAM AND AMCA SPARK RESISTANCE 'B' RATING
 4. PROVIDE WITH REMOTE MOUNTED UNIT CONTROLLER AND DISCONNECT SWITCH
 5. PROVIDE WITH INLINE DAMPER (24 VAC)
 6. PROVIDE WITH VIBRATION ISOLATION HANGERS AND SEISMIC RESTRAINTS
 7. NATIONALLY RECOGNIZED TESTING LABORATORY (NRTL) CERTIFIED TO UL 705 - POWER VENTILATOR FOR SMOKE CONTROL, PROVIDE ALL REQUIRED OPTIONS & ACCESSORIES.
 8. PROVIDE WITH MOTOR STARTER AND DISCONNECT SWITCH
 9. PROVIDE WITH BACKDRAFT DAMPER (FAN SELECTION SHALL ACCOUNT FOR DAMPER STATIC PRESSURE)
 10. PROVIDE WITH 12" HIGH SEISMIC ROOF CURB AND BIRDSCREEN
 11. PROVIDE GALVANIZED AIRCRAFT CABLES, MIN. 1/8" (QUANTITY FOUR) PER UNIT

AIR CURTAIN

SYMBOL	BASIS OF DESIGN	MODEL	LOCATION (AREA SERVED)	SUPPLY FAN				FURNACE NATURAL GAS HEATING				ELECTRICAL DATA				WEIGHT (LB)	REMARKS
				TOTAL CFM	MAX FPM NOZZLE	DOOR HEIGHT (FT.)	MOTOR HP	INPUT MBH	FLUE (IN)	GAS INLET (IN)	MIN GAS PRESSURE (W.G)	MAX GAS PRESSURE (IN. W.G)	VOLTS / PH / HZ	FLA	MOP		
C-1	BERNER	IDC12-2120G	VEHICLE ROLLUP DOOR	3268	5079	10	2 @ .5	145	6	34	5	14	480 / 3 / 60	4.9	15	249	ALL

REMARKS:
 1. PROVIDE DISCONNECT SWITCH AND SINGLE POINT POWER CONNECTION FOR MOTOR PANEL AND TRANSFORMER FOR HEATER.
 2. PROVIDE WITH MANUFACTURER UNIT CONTROLLER WITH BACNET CONNECTION, UNIT MOUNTED THERMOSTAT AND DOOR ACTIVATION SWITCH
 3. PROVIDE SEISMIC RESTRAINTS
 4. INSTALL PER MANUFACTURER'S INSTALLATION INSTRUCTIONS
 5. NATIONALLY RECOGNIZED TESTING LABORATORY (NRTL) CERTIFIED TO UL #1995
 6. PROVIDE STAINLESS AIR CURTAIN CABINET, TRANSITION AND HEATERS OPTION FOR AIR CURTAINS IN CAR WASH BAY.

INFRARED HEATER SCHEDULE

SYMBOL	BASIS OF DESIGN MAKE / MODEL	LOCATION (AREA SERVED)	DESCRIPTION	MAX INPUT (BTU/HR)	MIN GAS PRESSURE (W.G)	MAX GAS PRESSURE (IN. W.G)	TUBE LENGTH	TUBE MATERIAL	NUMBER OF BURNERS/ ELEC. CONNECTIONS	VOLTS / PH / HZ	FUEL	REMARKS
IRH-1 & 2	R & G / CRV-B2	MAINTENANCE SHOP	INFRARED HEATER	120,000	4.5"	14"	CUSTOM	HOT ROLLED STEEL	6	120 / 1 / 60	NATURAL GAS	ALL

VACUUM PUMP (FOR INFRARED HEATERS)							
SYMBOL	BASIS OF DESIGN MAKE / MODEL	SERVING	DESCRIPTION	HP	VOLTAGE / PH / HZ	FULL LOAD AMPS	REMARKS
VP-1 & 2	EP- 100	IRH-1 & 2	VACUUM PUMP	1/3	120 / 1 / 60	6.6 / 3.33	ALL

REMARKS:
 1. SEE MOUNTING DETAILS ON DETAIL SHEETS
 2. PROVIDE WITH NON-FUSED DISCONNECT. UNIT SHALL BE HARD WIRED TO DISCONNECT
 3. PROVIDE WITH PROGRAMMABLE THERMOSTAT WITH BACNET CONNECTION



PROPOSAL

MASSACHUSETTS BAY TRANSPORTATION AUTHORITY
GREEN LINE EXTENSION PROJECT
 MBTA CONTRACT NO. E22CN04
 CAMBRIDGE/SOMERVILLE, MASSACHUSETTS

**VEHICLE MAINTENANCE FACILITY
 MECHANICAL HVAC
 EQUIPMENT SCHEDULE**

GV20170258-275.pdf

SCALE: AS NOTED	DRAWN BY: KJM	DESIGN BY: CPD	CHECK BY: ND	PLAN NO.	ISSUE
DATE: SEPT. 28, 2017	ISSUE	DESCRIPTION	BY	CHKD	APP.

DATE: SEPT. 28, 2017 SHEET: VMF-014

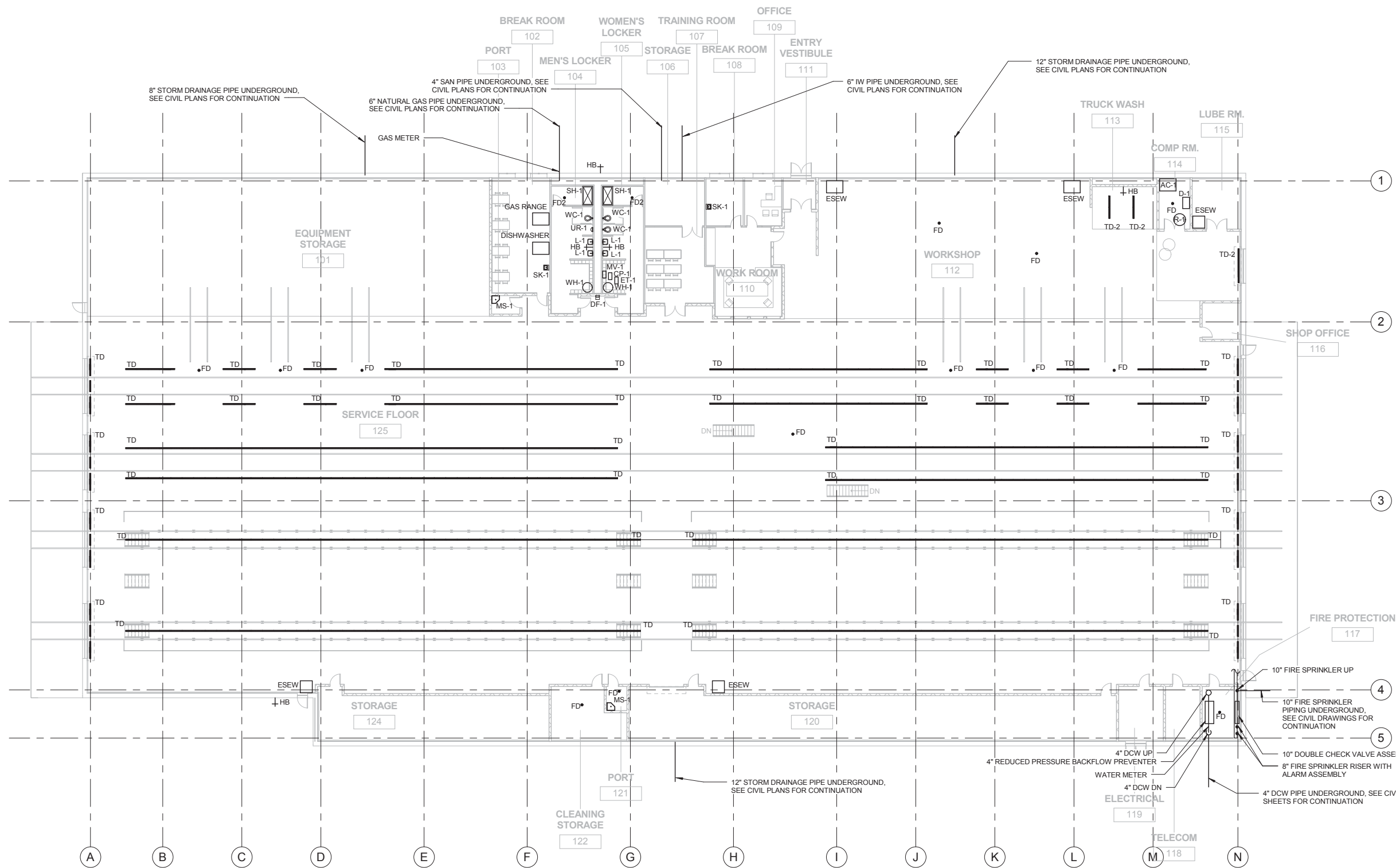

FIRST FLOOR PLAN

1/16" = 1'-0"



PROPOSAL

MASSACHUSETTS BAY TRANSPORTATION AUTHORITY



GREEN LINE EXTENSION PROJECT
 MBTA CONTRACT NO. E22CN04
 CAMBRIDGE/SOMERVILLE, MASSACHUSETTS

**VEHICLE MAINTENANCE FACILITY
 PLUMBING AND FIRE PROTECTION
 FLOOR PLAN**



GV20170258-275.pdf



SCALE:	DRAWN BY:	DESIGN BY:	CHECK BY:	PLAN NO.:	ISSUE:
DATE: SEPT. 28, 2017	JLO	JLO	JO	SHEET: VMF-015	

ISSUE	DATE	DESCRIPTION	BY	CHKD	APP.

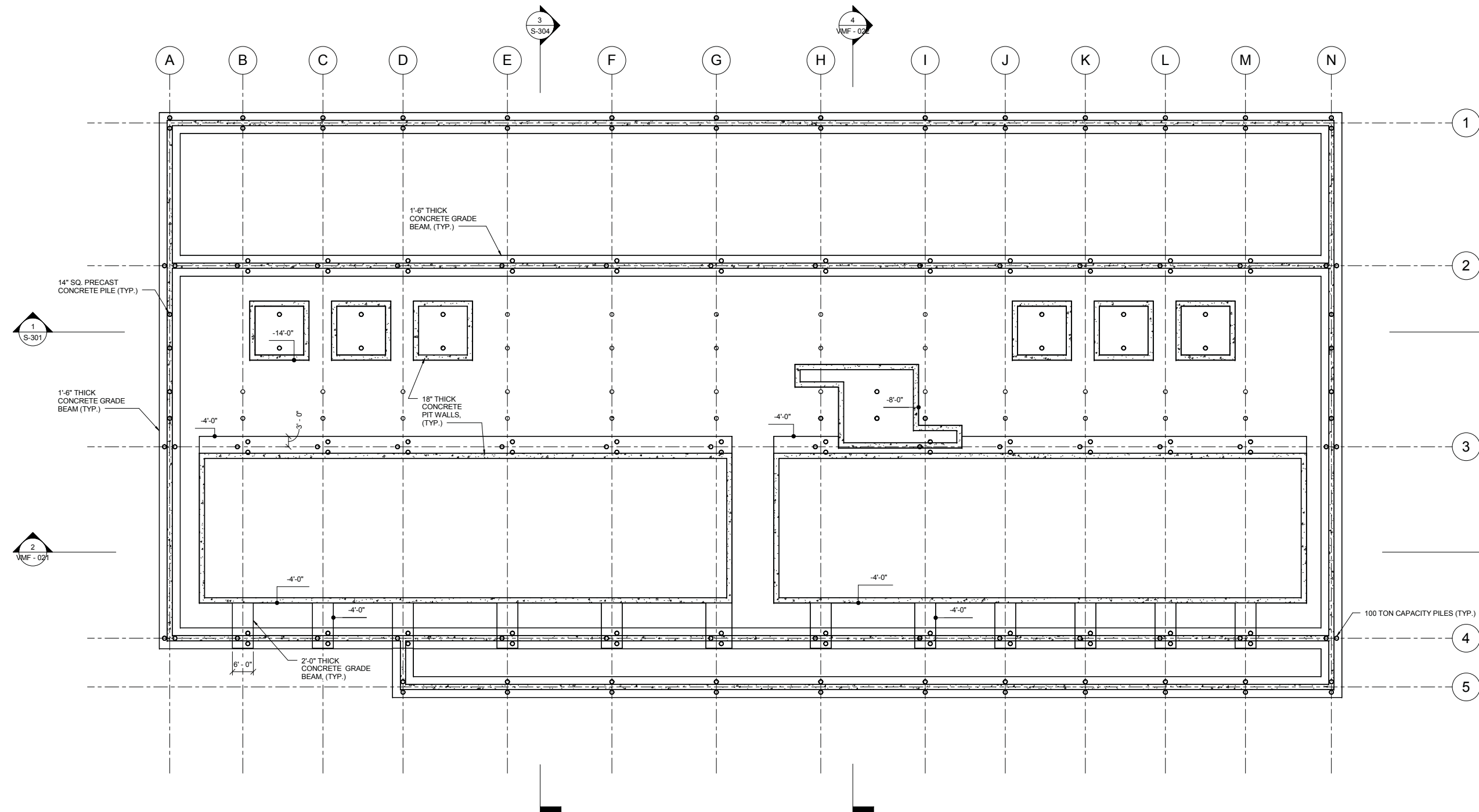

FOUNDATION PLAN



NOTE:
 ALL PILES CENTERED ON COLUMN LINES 1, 5, A, AND N. TRACKS 3 AND 4 ARE TO BE 70 TON CAPACITY U.N.O.
 ALL OTHER PILES ARE TO BE 100 TON CAPACITY U.N.O.

PROPOSAL
 MASSACHUSETTS BAY TRANSPORTATION AUTHORITY
GREEN LINE EXTENSION PROJECT
 MBTA CONTRACT NO. E22CN04
 CAMBRIDGE/SOMERVILLE, MASSACHUSETTS

**VEHICLE MAINTENANCE FACILITY
 FOUNDATION PLAN**



GV20170258-275.pdf

SCALE: AS NOTED	DRAWN BY: ZS	DESIGN BY: AD	CHECK BY: ND	PLAN NO.	ISSUE
DATE: SEPT. 28, 2017				SHEET: VMF-016	

ISSUE	DATE	DESCRIPTION	BY	CHKD	APP.

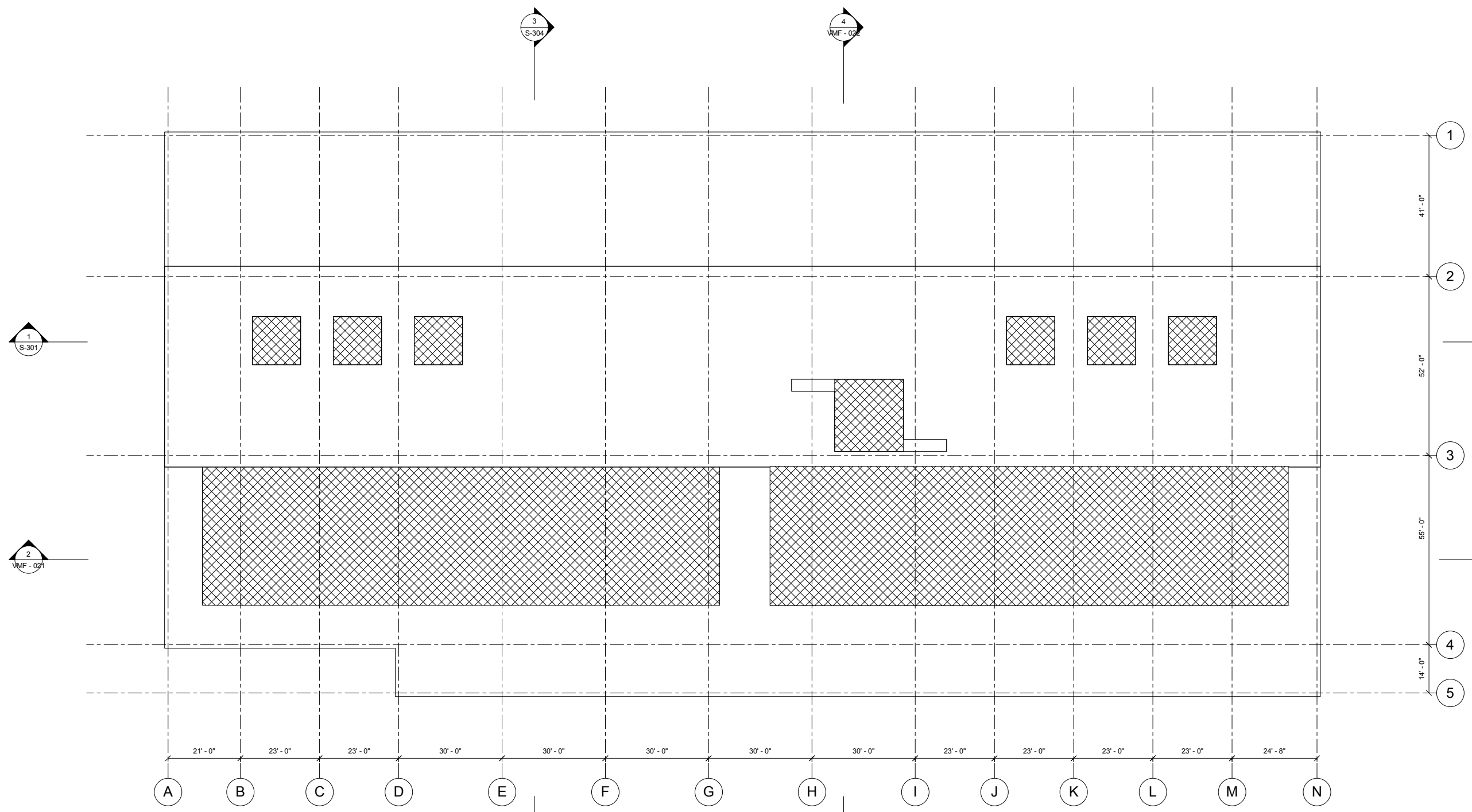

1
S-301

2
VMF-021

3
S-304

4
VMF-02

PIT SLAB PLAN

1/16" = 1'-0"

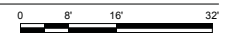

LEGEND



2" THICK SLAB

PROPOSAL

MASSACHUSETTS BAY TRANSPORTATION AUTHORITY
GREEN LINE EXTENSION PROJECT
 MBTA CONTRACT NO. E22CN04
 CAMBRIDGE/SOMERVILLE, MASSACHUSETTS

**VEHICLE MAINTENANCE FACILITY
 PIT SLAB PLAN**



GV20170258-275.pdf

ISSUE	DATE	DESCRIPTION	BY	CHKD	APP.	SCALE:	DRAWN BY:	DESIGN BY:	CHECK BY:	PLAN NO.:	ISSUE	
						AS NOTED	ZS	AD	ND	VMF-017	1	
							DATE: SEPT. 28, 2017				SHEET: VMF-017	

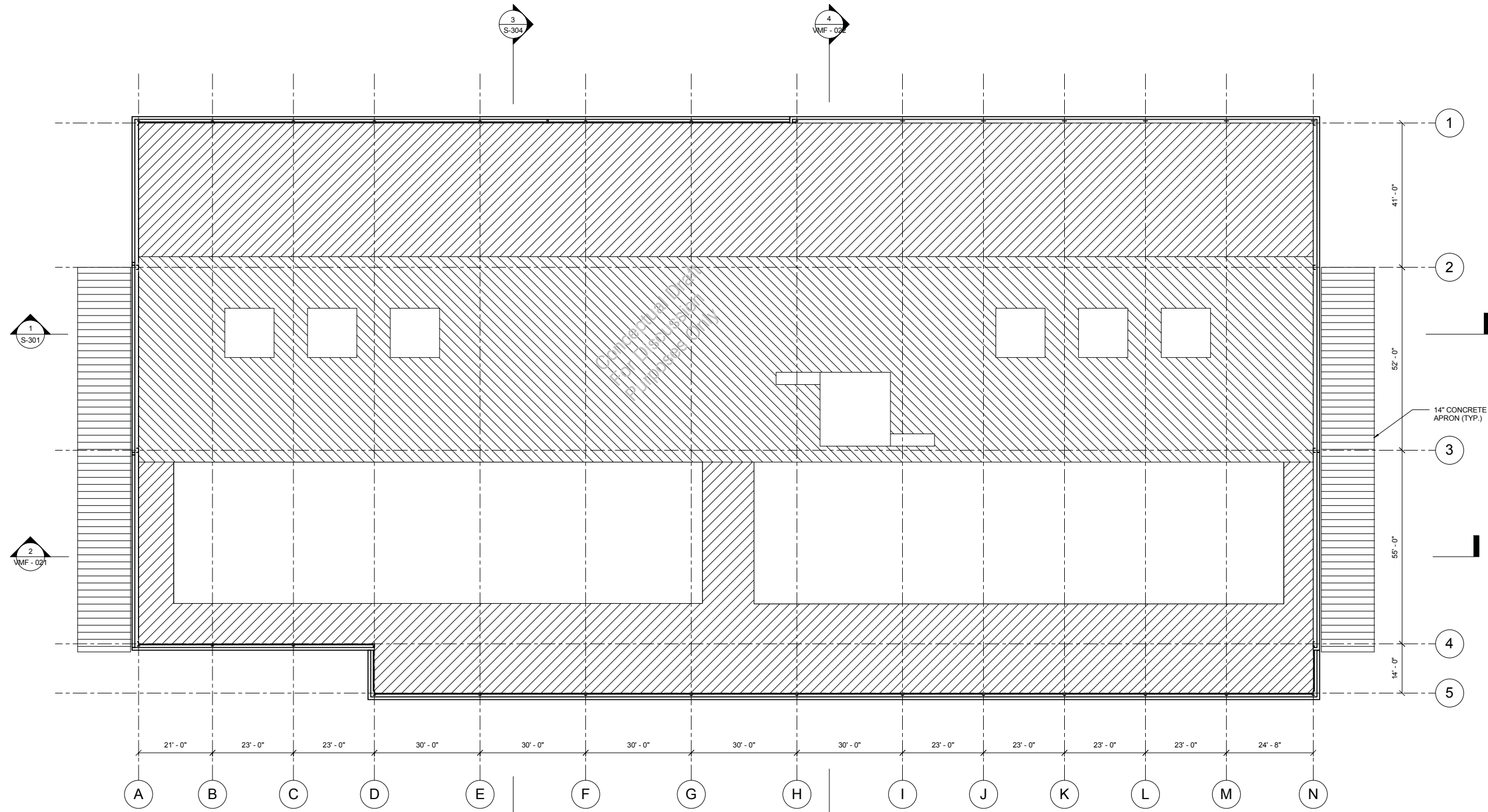

MAIN FLOOR SLAB PLAN

1/16" = 1'-0"
 0 8' 16' 32'

LEGEND

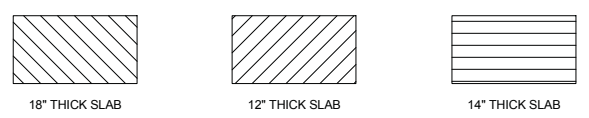

PROPOSAL

MASSACHUSETTS BAY TRANSPORTATION AUTHORITY
GREEN LINE EXTENSION PROJECT
 MBTA CONTRACT NO. E22CN04
 CAMBRIDGE/SOMERVILLE, MASSACHUSETTS

**VEHICLE MAINTENANCE FACILITY
 MAIN FLOOR SLAB PLAN**



GV20170258-275.pdf

SCALE: AS NOTED	DRAWN BY: ZS	DESIGN BY: AD	CHECK BY: ND	PLAN NO.	ISSUE
DATE: SEPT. 28, 2017				SHEET: VMF-018	
ISSUE	DATE	DESCRIPTION	BY	CHKD	APP.

9/21/2017 1:58:47 PM
 C:\Users\packarsj\Documents\VMF_S_300000_pac\packarsj.rvt

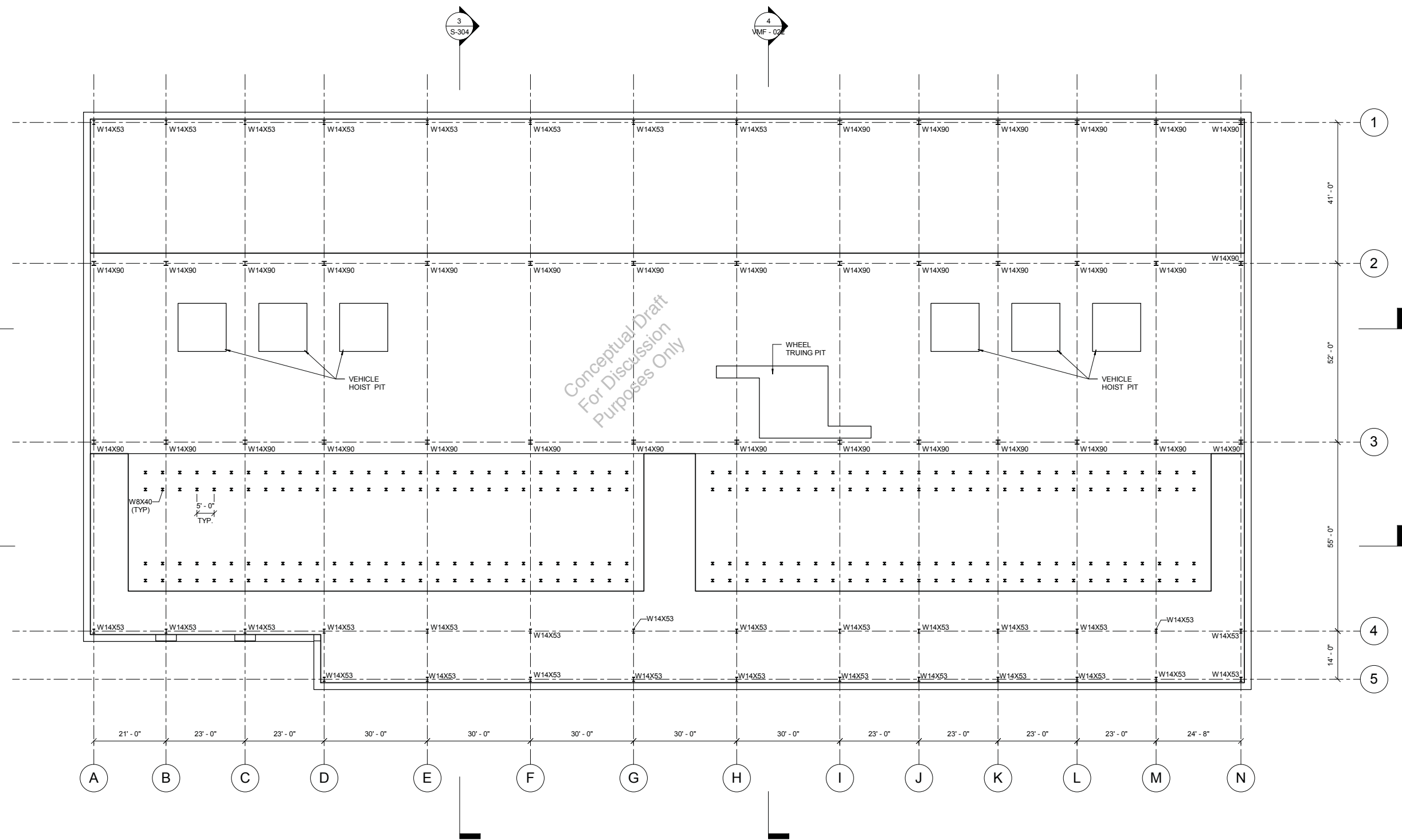

Conceptual Draft
 For Discussion
 Purposes Only



PROPOSAL

MASSACHUSETTS BAY TRANSPORTATION AUTHORITY
GREEN LINE EXTENSION PROJECT
 MBTA CONTRACT NO. E22CN04
 CAMBRIDGE/SOMERVILLE, MASSACHUSETTS

**VEHICLE MAINTENANCE FACILITY
 FRAMING PLAN
 COLUMN AND TRACK PEDESTALS**



GV20170258-275.pdf

ISSUE	DATE	DESCRIPTION	BY	CHKD	APP.

SCALE: AS NOTED	DRAWN BY: ZS	DESIGN BY: AD	CHECK BY: ND	PLAN NO.	ISSUE
DATE: SEPT. 28, 2017				SHEET: VMF-019	

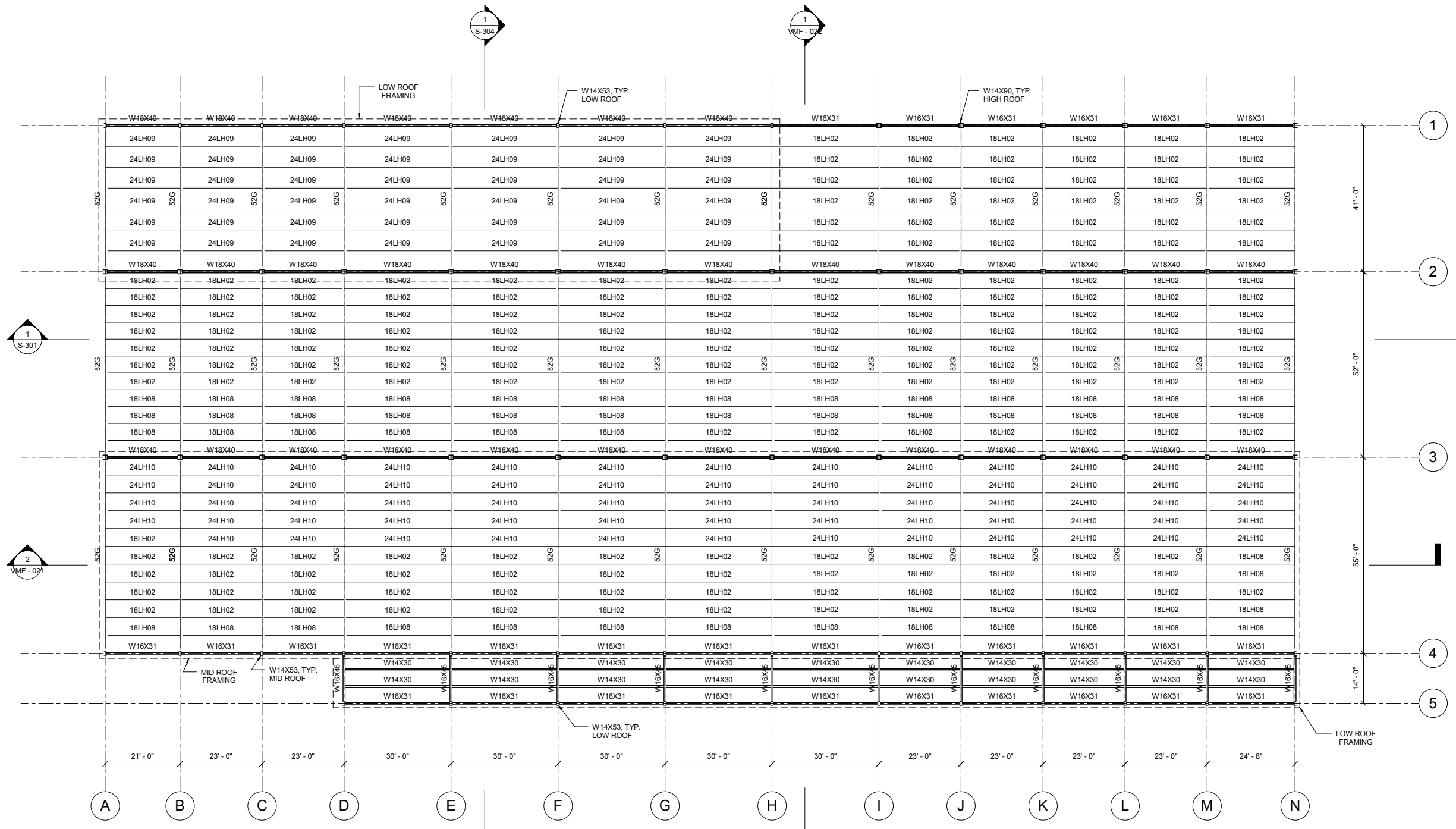

HIGH ROOF FRAMING PLAN

1/16" = 1'-0"

PROPOSAL

MASSACHUSETTS BAY TRANSPORTATION AUTHORITY
GREEN LINE EXTENSION PROJECT
 MBTA CONTRACT NO. E22CN04
 CAMBRIDGE/SOMERVILLE, MASSACHUSETTS

**VEHICLE MAINTENANCE FACILITY
 ROOF FRAMING PLAN**



GV20170258-275.pdf

ISSUE	DATE	DESCRIPTION	BY	CHKD	APP.

SCALE: AS NOTED	DRAWN BY: ZS	DESIGN BY: AD	CHECK BY: ND	PLAN NO.	ISSUE
DATE: SEPT. 28, 2017				SHEET: VMF-020	

9/21/2017 1:58:48 PM C:\Users\packarsj\Documents\VMF_S_300000_pac\karsj.rvt

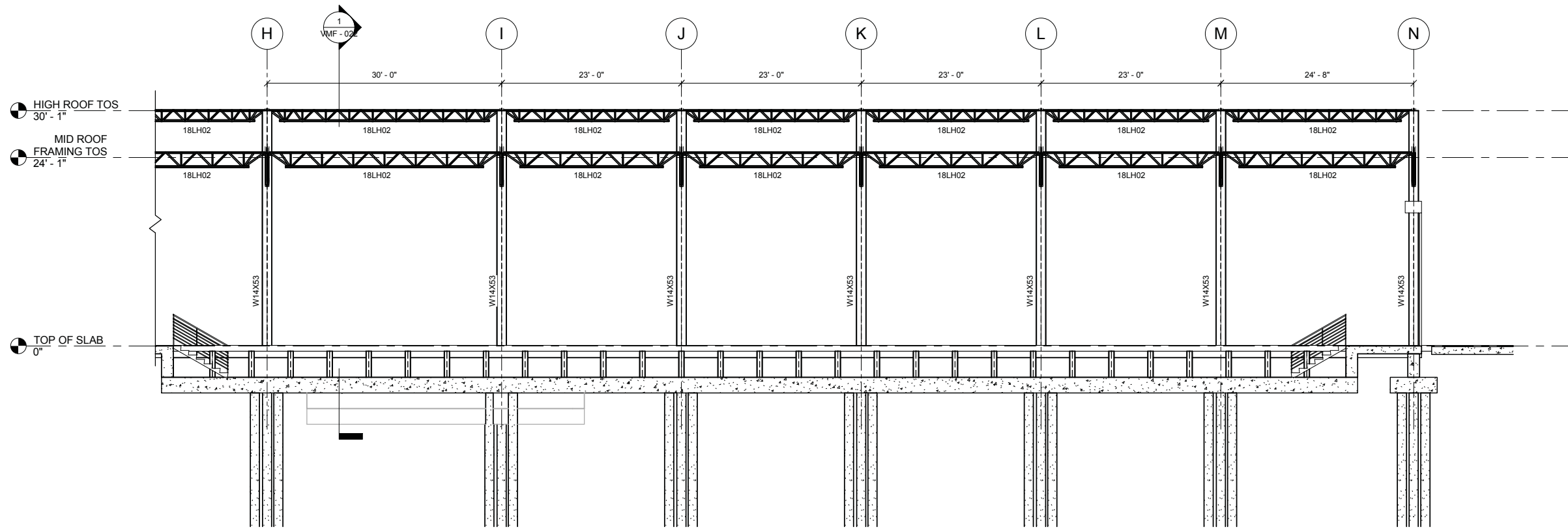

1 LONGITUDINAL SECTION PART A
S-304 1/8" = 1'-0"

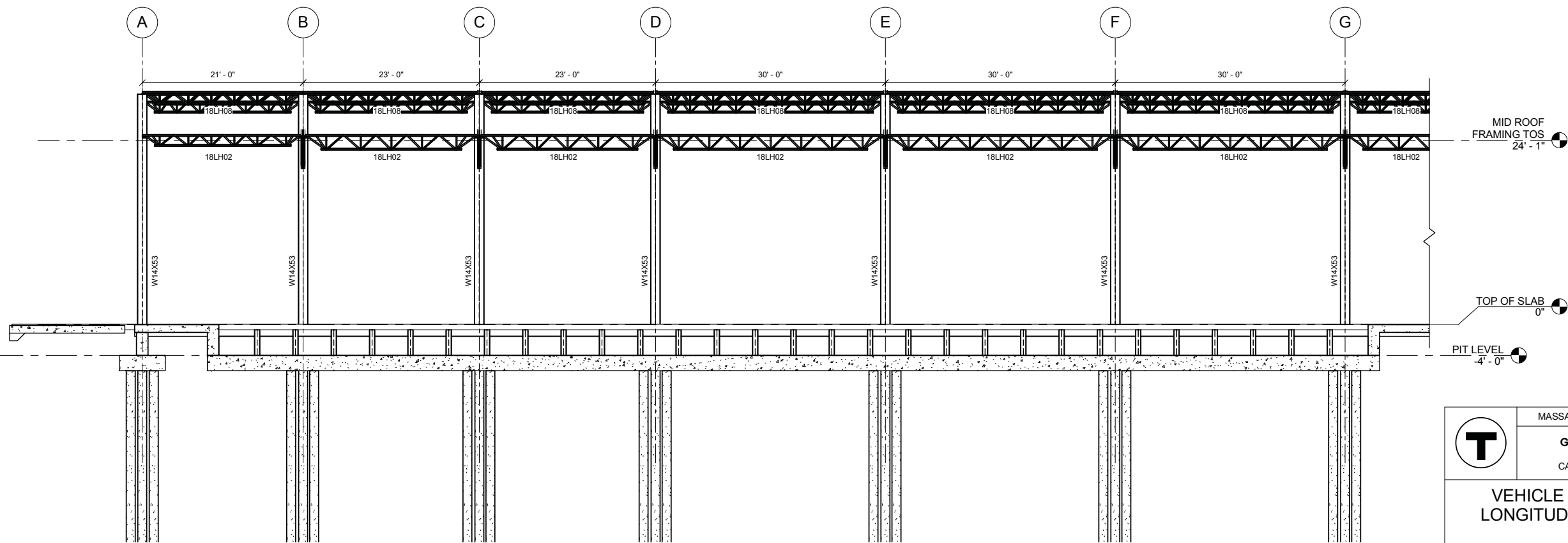

2 LONGITUDINAL SECTION PART B
S-105 1/8" = 1'-0"

PROPOSAL
 MASSACHUSETTS BAY TRANSPORTATION AUTHORITY
GREEN LINE EXTENSION PROJECT
 MBTA CONTRACT NO. E22CN04
 CAMBRIDGE/SOMERVILLE, MASSACHUSETTS

**VEHICLE MAINTENANCE FACILITY
 LONGITUDINAL BUILDING SECTIONS**

STV 100 years
massDOT Massachusetts Department of Transportation
GLX CONSTRUCTORS

SCALE: AS NOTED
 DATE: SEPT. 28, 2017
 DRAWN BY: ZS
 DESIGN BY: AD
 CHECK BY: ND

PLAN NO.
 SHEET: VMF-021

ISSUE

9/21/2017 1:58:50 PM
 C:\Users\packarsj\Documents\VMF_S_300000_pac\karsj.rvt

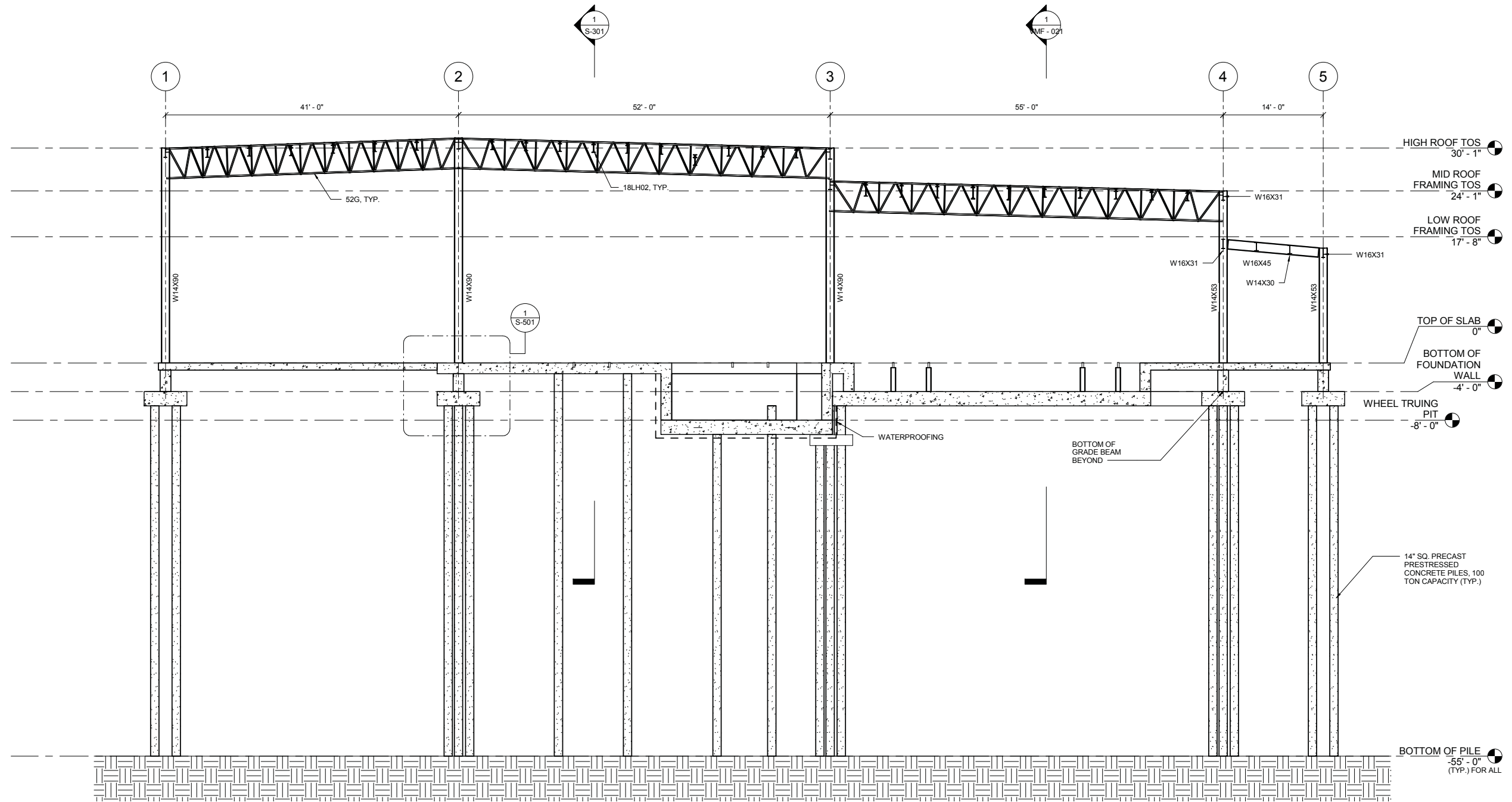

1 TRANSVERSE SECTION
 S-105 1/8" = 1'-0"
 0 4' 8' 16'

PROPOSAL

MASSACHUSETTS BAY TRANSPORTATION AUTHORITY
T
GREEN LINE EXTENSION PROJECT
 MBTA CONTRACT NO. E22CN04
 CAMBRIDGE/SOMERVILLE, MASSACHUSETTS

**VEHICLE MAINTENANCE FACILITY
 TRANSVERSE BUILDING SECTION**



GV20170258-275.pdf

SCALE: AS NOTED	DRAWN BY: ZS	DESIGN BY: AD	CHECK BY: ND	PLAN NO.	ISSUE
DATE: SEPT. 28, 2017				SHEET: VMF-022	
ISSUE	DATE	DESCRIPTION	BY	CHKD	APP.

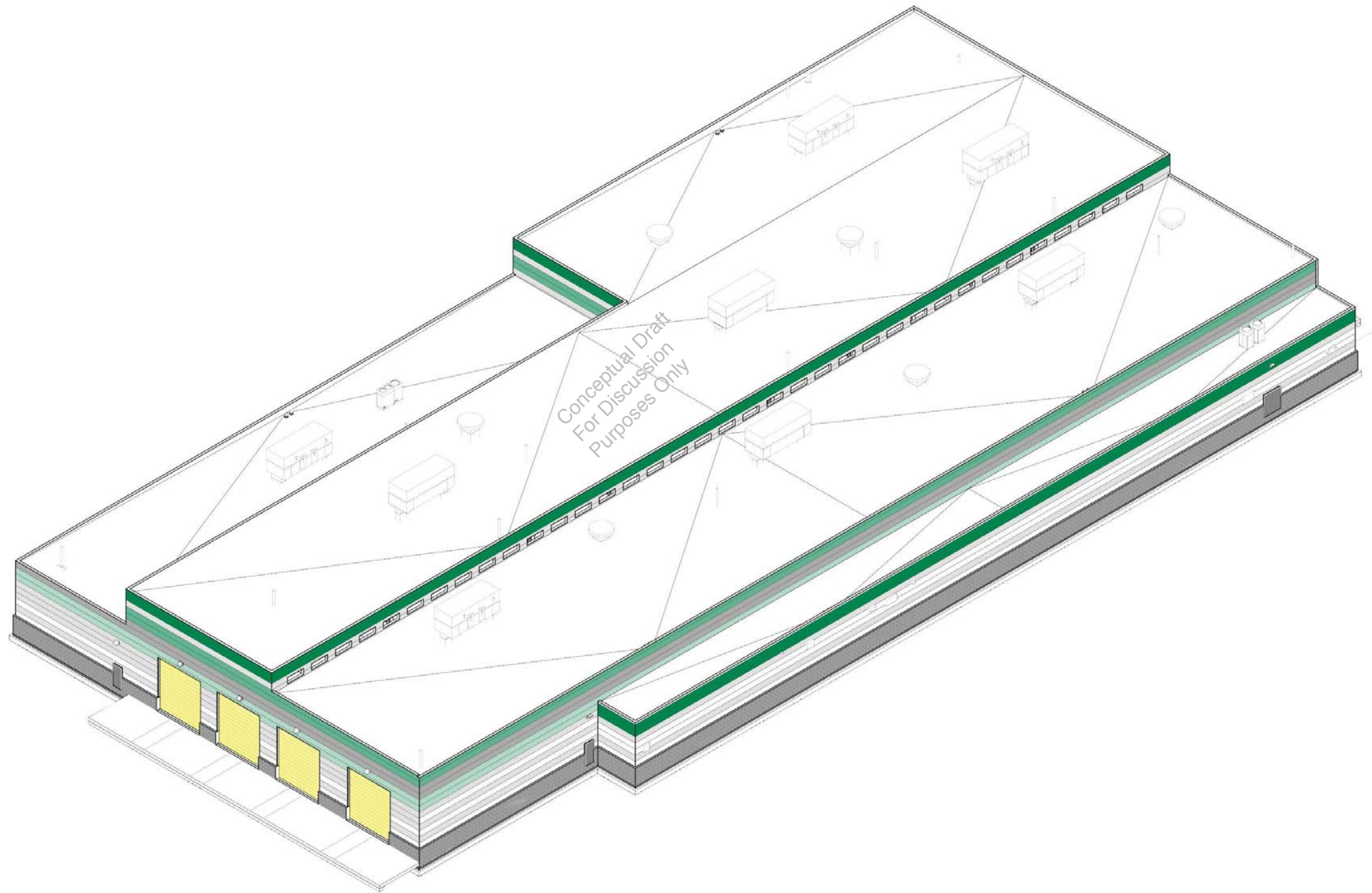

Conceptual Draft
For Discussion
Purposes Only

PROPOSAL

MASSACHUSETTS BAY TRANSPORTATION AUTHORITY



GREEN LINE EXTENSION PROJECT
MBTA CONTRACT NO. E22CN04
CAMBRIDGE/SOMERVILLE, MASSACHUSETTS

**VEHICLE MAINTENANCE FACILITY
3D REPRESENTATIONS
AND ISOMETRICS**



GV20170258-275.pdf

ISSUE	DATE	DESCRIPTION	BY	CHKD	APP.	SCALE:	DRAWN BY	DESIGN BY	CHECK BY	PLAN NO.	ISSUE
						DATE: SEPT. 28, 2017	SP	SP	ND	SHEET: VMF-023	1

“
Our team is composed of seasoned professionals to manage horizontal and vertical spatial constraints for the design of the track and all necessary civil components in support of the work.

4.6 CIVIL AND GUIDEWAY

GLX Constructors has delivered a low cost design and construction solution for Civil and Guideway through a revised track and Community Path alignment that reduce work required to complete retaining walls, bridge spars, and track grades while avoiding conflicts with utilities and third parties. Our efficient design provides the MBTA greater certainty the Project will be completed on schedule

During the proposal process, we expended significant time and effort to optimize the design provided by the MBTA.

Our engineers focused on rail design to enhance our design accuracy. The proposed track center line alignments and top-of-rail profiles drive many heavy civil components of the Project, such as earthwork, grading, retaining walls, drainage, and cross-section development. Our efforts during the proposal phase will allow our team to accelerate the Project schedule.

4.6.A APPROACH TO CIVIL AND GUIDEWAY COMPLIANCE

GLX Constructors has reviewed the Technical Provisions Section 10.1 and 10.2 and subsequent addenda to establish the project design criteria, which we used to cross check the provided Definition Plans and verify their compliance. The Technical Provisions served as the starting point for our proposed design enhancements and Alternative Technical Concepts (ATC).

During our evaluation, we identified several opportunities for optimization within the horizontal and vertical alignments and the special trackwork. The following is a summary of our findings.

Horizontal Track Alignment Revisions. We have revised the Project Definition Plan’s horizontal alignments at many locations. All revisions generate cost savings, contributing to the MBTA’s cost certainty goals without sacrificing quality or performance. Some of our revisions are Project improvements, noted below.

Horizontal Track Alignment Improvements	Technical Drawing
Revised the Medford Branch (MB) and New Hampshire alignments to eliminate impacts to the Walnut Street west abutment.	Sheets C-011 to C-012, C-035 to C-036
The MB north approach alignment to the East Somerville Station has been revised to reduce the Washington Street Bridge width.	Sheets C-009 to C-011
The MB alignments at the Gilman Station were revised to improve platform geometry by allowing it to be completely tangent. This allows for room for the required south elevator and stairs on the concourse, while eliminating ROW impacts just north of the Medford Street bridge.	Sheets C-012 to C-014, C-036 to C-038

Horizontal Track Alignment Improvements	Technical Drawing
The MB alignment at the Magoun Station was revised to improve platform geometry. It is now completely tangent and the platform edges parallel. This allows for room for the south elevator and the stairs on the station concourse. The MB-WB alignment centerline is only 6 feet from the ROW corner at Sta.312+50 in the Definition Plans. In this case, the ballast shoulder and emergency walkway would have been on the neighboring property. The revised alignment has been shifted to the east to allow room for the ballast shoulder and emergency walkway.	Sheets C-017 to C-018
The West Bound-MB north approach alignment to the Ball Square Station was revised to eliminate ROW impacts. The Definition Plans’ alignment was only 5 feet from the ROW from Sta. 336+00 to Sta. 338+00. The ballast shoulder and emergency walkway would be on the neighboring property. The revised alignment has been shifted to the east to allow room for the ballast shoulder and emergency walkway.	Sheet C-020
The MB north approach alignment to the College Ave. Station was revised to reduce the height of the east retaining wall along Boston Ave.	Sheets C-023 to C-024
Both the east- and west-bound Union Square Branch alignments were revised at the eastern approach to the Union Square Station. This allows the platform to be tangent, instead of the curved platform as shown in the Definition Plans. Technical Provision Section 10.2.3.2 (c) (ii) (A) requires the horizontal alignments to be tangent through the entire platform.	Sheets C-030 to C-031
The VMF loop track’s horizontal alignment was revised to improve the grading for the Third Avenue VMF entrance. This allows for a 5-foot raise of the VMF and Car Storage Yard track profiles that will substantially reduce the proposed grading excavation.	Sheet C-051

Figure 4.6-1. Horizontal Track Alignment Improvements. *The horizontal improvements that GLX Constructors have made will reduce Project costs and shorten schedule duration.*

Vertical Track Alignment Revisions. We have revised the Definition Plan’s vertical alignments as noted below.

Vertical Track Alignment Improvements	Technical Drawing
The New Hampshire profile has been modified to minimize track undercutting, earth excavation, retaining wall heights, and other drainage related items. These profile revisions still allow for a minimum of 17.75’ of vertical clearance under bridges to meet Technical Provision Section 10.1.3.5 (d) (i).	Sheets C-033 to C-049
The MB profile has been raised in various areas north of Washington Street to minimize excavation for the roadbed and retaining wall height.	Sheets C-010 to C-024
The MB and EB Union Square profiles have been lowered at the south half of the viaduct. The viaduct piers and columns constructed under an advanced contract will not be impacted by the lowered profiles. The revised profile will still meet the required 16.5-foot street vertical clearance for the bus loop driveway, as required by Section 8.7.3.9. The revised profile meets the 12.5-foot vertical clearance for the bus loop driveway, as required by Section 7.2.3.6 (a) (i).	Sheets C-003 to C-007, C-032

“
We have revised the horizontal and vertical alignments to capture cost savings and shorten project schedule.

Vertical Track Alignment Improvements	Technical Drawing
The top of rail profiles were raised for the yard lead tracks, car storage tracks, and the VMF track. This 5-foot raise above the Definition Plans yard profiles decreases project earth excavation and retaining walls for the yard leads and car storage area. Large amounts of excavation from other project areas can also be used as fill within the VMF to meet the 5-foot raise and improve the balance of earthwork throughout the Project instead of trucking soil offsite.	Sheets C-053 to C-055

Figure 4.6-2. Vertical Track Alignment Improvements. *The vertical improvements that GLX Constructors have made will reduce Project costs and shorten schedule duration.*

Special Trackwork Revisions

We propose revising the track alignment with standard diamond crossovers.

Special Trackwork Improvements	Technical Drawing
The custom diamond crossover for the Union Square Station approach will be replaced with a standard #8 diamond crossover. The US-EB speed must be 15 mph, as the alignment travels through the diverging route of the custom #8 turnout of the diamond crossover. The standard diamond crossover will allow for a speed of 20 mph and is a project operational improvement.	Sheets C-030 to C-031
The Yard Lead 2 and Yard Lead 3 custom diamond crossover at the Brick Bottom Interlocking will be replaced with a standard #6 diamond crossover.	Sheets C-050, C-052

Figure 4.6-3. Special Trackwork Improvements. *Identified trackwork improvements will lead to cost certainty and operational efficiency.*

Track Construction Staging

We have developed track staging plans for the Washington Street Bridge Construction. Three stages have allowed for both mainline New Hampshire tracks and Yard Lead 10 to be in service at all times, except for a few weekend single-track operations.

By shifting the New Hampshire Line Tracks to allow for the new MB construction, we are proposing three stages. Each stage is roughly one-third of the New Hampshire Line length and will involve some relaying of the exiting track material. We anticipate very little impact to the commuter operations during this shifting work.

The MB Construction will have conventional construction staging after the New Hampshire Tracks are shifted to the east. Following, the MB construction will have little impact to train operations.

The Union Square Branch construction will also have conventional staging. The existing Fitchburg tracks will be relocated out of the Union Square Branch by an advanced contract. The Union Square construction will have little impact to train operations.

Features, Rationales, and Limitations of Alignment Design Elements

GLX Constructors has made significant improvement to of the features and rationale of the alignment design elements.

Design Speed. The design speeds are the same as the provided by the Definition Plans.

Transitions between the Various Track Bedding Types. Using ballasted deck bridges, the transitions will be eased between fill and structure. To prevent differential settlement, we will use approach slabs at the Harvard Street Bridge on the New Hampshire Line and at the Medford Street Bridge on the Union Square Branch.

Clearance Envelope. Our design complies with the minimum clearance envelopes for the Commuter Line and Light Rail Branches, as specified in the Technical Provisions. The only exception is where the Definition Plans deviate from clearance at Sta. 10+75 (Horizontal clearance of 6.25 feet). This exception is required for the Fitchburg Line work, which is not part of the Green Line Extension Contract. See Sheet C-028.

Line of Sight. Proper lines of sight safely provide greater reaction times for the vehicle operators. The Project will be designed to allow for maximum lines of sight. Proposed Green Line signals will be placed free of obstruction and clearly in the operator’s line of sight per the Project’s Technical Provisions, Section 11.

Approaching Stations. Our team will realign the track approaches to the East Somerville, Gilman, Magoun, Ball Square, College Avenue, and Union Square Stations. These changes improve the platform geometry, allow for the proposed elevators stairs to fit on the approach concourses, and eliminate ROW issues. Our designs speeds are the same as the Definition Plans at the station approaches.

Structural Crossings. Our design meets all vertical clearances at all of the grade-separated crossings along the Project alignment.

Special Track Work. GLX Constructors has used the same turnout sizes as the Definition Plans. The minimum mainline turnouts are to be #8 per Technical Provision 10.2.3.3 (k) (iii). A #10 left-hand mainline crossover was used on the Union Square Branch in the Definition Plans.

Definition Plans called for #6 Crossovers at the East Somerville Interlocking and a #6 turnout for the US-EB track connection to the Yard Lead 4. These are smaller than standard sizes on the mainline tracks because of constricted geometry. GLX Constructors will use the same turnouts at these locations as the Definition Plans.

The mainline crossovers at Sta. MB-EB 210+ and Sta. MB-EB 319+00 can be modified #6 hand-throw electric lock per Technical Provision 10.2.3.3 (k) (vii).

Yard Lead crossovers are #6 turnouts per Definition Plans and meet MBTA track standards. These are non-revenue tracks. See Sheets C-050 and C-052. The Yard Turnouts are a minimum 150-foot curve radius, Fully Guarded per Technical Provision 10.2.3.3 (n) (iii) the same as the Definition plans.

There is no new special trackwork on the New Hampshire Line along the Project.

Geometric Horizontal and Vertical Alignment Design Brief

GLX Constructors has implemented a number of changes in both horizontal and vertical alignment that will result in construction or operational cost savings and overall Project improvements. Each modification was developed in accordance with the Technical Provisions.

Conducting a thorough proposal review of the geometric alignments, we identified new and exciting design exceptions. Improving on existing geometry, 12 design exceptions detailed within Appendix 1 – Design Criteria Exceptions – Track, prepared by AECOM/HNTB, Dated 11-21-2014, were carried over, and 21 additional design exceptions are required because of existing structures, geography, and grading plans.

The 12 exceptions carried over apply to the light rail system and include five locations along Union Square branch, where minimum horizontal or vertical tangent track lengths cannot be met because of profile grading and/or Right of Way (ROW) constraints. Six of the remaining seven exceptions reference Volume 2 Technical Provisions, Section 10.2.3.2.c.iii.B, and exceed the maximum unbalance of 0.50 inches, two of which are designated as OPEN within AECOM/HNTB Attachment A (#68 and #69). These are no longer relevant because our improved design reduces the unbalance at these curves below the maximum of 0.50 inches.

The additional 21 exceptions identified by GLX Constructors include similar scenarios where maximum vertical or horizontal tangent track cannot be met, curve sections of track are within the minimum 45-foot tangent section of track from platform edge, or curve unbalance super elevation exceeds the maximum of 0.50 inches.

Of the additional 21 exceptions, several exceptions are required based on existing/provided alignment geometry that was not identified in the AECOM/HNTB Attachment A, dated 11-21-2014. These exceptions are in relation to minimum track spacing, one located within the MB Viaduct and the other exception required for the commuter rail, where it is required to blend into existing track territory along New Hampshire from Station 87+17 to Station 89+16. Two other track spacing design exceptions are required because of existing site constraints and interference with the ROW, which prohibits additional centerline spacing with incremental inches required by super elevation and degree of curvature.



“To mitigate the impact to abutters and many important businesses around the Green Line, we will employ a philosophy of avoid, minimize, or mitigate.”

We have compiled an extensive list of exceptions that might possibly be needed during final design and for brevity have included three of them below as an example.

COMMUTER AND LIGHT RAIL DESIGN EXCEPTIONS			
Element	Description	Ref. Sect	Ref. Doc.
Light Rail	The tangent preceding MAF turnout 10 (PS SW – 25+23.54) is 8.15 feet due to alignment	1.6.2.1.6	GLX Design Criteria Manual
Light Rail	Curve US-WB 2 – Required speed of 25 MPH results in an unbalance superelevation of greater than the maximum allowable 0.5 inches. Superelevation cannot be increased without impact to #10 turnout east of curve or running off superelevation on tangent. Proposed unbalance superelevation for this curve shall be 0.60 inches.	1.6.2.1.4.3B	GLX Design Criteria Manual
Light Rail	The tangent preceding MAF turnout 13 (PC Sta= 27+81) is 1.7 feet due to alignment constraints	1.6.2.1.6	GLX Design Criteria Manual

Figure 4.6-4. Commuter and Light Rail Design Exceptions. An example of the commuter and light rail design exceptions.

For features of alignment segments that confirm compliance with the geometric criteria of the Volume 2 Technical Provisions, see Section 4.6.A.

Design Approach and Criteria of the Wayside Elements

Coordination and integration are two key measures in the wayside design approach. In a tight corridor, such as the Green Line, every decision to place a structure or element along the ROW will have an impact on other disciplines. For example, the location of the OCS poles will impact the placement of signals, since the location of OCS can cause sight line issues with the LRV operator seeing a wayside train control signal.

The OCS pole layout will be closely coordinated with our Civil Team; to avoid clashes with drainage and underground structures during construction. There will be a hierarchy of precedence for wayside items along the ROW; we will build items such as walls, bridges, and other large structures first because they take the highest priority of location.

Utilities will be next. Items like culverts, drainage pipe, and pump stations are driven by the topology of the ROW and have some adjustability, but they must be designed early and cannot be revised once the design is complete. The system elements, OCS poles, ductbanks, troughs, CIH, and signals have the most flexibility in terms of their location. Once all civil and structural items have been preliminarily located, the systems group will analyze the remaining property and design the systems around available property.

With close Design-Build coordination conflicts will be identified early, formally tracked, and resolved to provide a fully coordinated and integrated light rail corridor.

Conduit Provisions for System Installation. Conduit provisions of systems along the ROW will be a system-wide trough for the installation of

communication and train control cables. Junction boxes will be installed to break the cables out of the trough and route the wayside devices. There will be spare capacity built into all conduit installations per the Technical Provisions. Aerial cabling will also be used along the corridor to minimize impacts to sub-surface work. For example, to maintain two separate paths for the communications fiber path, one run will be in the trough and a second will be aerial along the OCS poles. Conduit provisioning along the corridor will allow no more than 40 percent fill for the conduit, and it will be fully compliant with the Technical Provisions, Section 7.4.

Civil Infrastructure Installed in Support of the Signaling and Communications Equipment and Electrification

To maximize construction and minimize impacts on schedule, our Civil Infrastructure Team will install conduits and foundations for the signaling, power, and communications equipment along the ROW. The coordination between Civil Infrastructure and System Teams will limit excavation during the early stages of design on the Green Line Extension. We will install the infrastructure for systems elements to avoid subsurface work after final grade has been established or sub-ballasts have been placed. The intent is to dig once, and then work vertically from the ground.

Community Path Continuous Plan and Profile Drawings. The proposed community path will create a pedestrian and cyclist path that is a continuation of the existing path that terminates just south of the Lowell Street Bridge. The community path will provide a conduit for users between the existing path and the sidewalk at Washington Street, Somerville. The design will be in accordance with the FHA, AASHTO, and MUTCD guidelines pertaining to bicycle facilities and trails. The community path is designed to be ADA/MAAB accessible with maximum longitudinal grades no greater than 5 percent, and cross slope grading less than 2 percent, with a minimum grade of 0.5 percent while maximizing pedestrian and cycle comfort.

The community path’s 10-foot width with 1-foot-wide shoulders will enhance the cyclist experience and will prevent cyclists and pedestrians from feeling constrained along the path. Grading the community path is partially dictated by meeting the existing grades at the roadway bridge and sidewalk crossings at Central Street, Sycamore Street, and School Street, and crossing beneath Medford Street and Walnut Street in underpass structures.

We will achieve the community path’s positive drainage by pitching flow across the impervious travel surface toward the pervious shoulder and collecting runoff in subsurface perforated pipes and inlet structures that will combine with track

drainage. The grading design requirement also allows for shedding drainage flow efficiently from the community path’s travel surface and eliminating areas of ponding. Where necessary, the community path will be elevated above the proposed track and wayside elements by viaduct structures.

We will provide lighting at key locations, such as connection points at the existing roadway bridges and at underpass structures, at illumination levels to provide a safe environment for all users. For user safety, emergency call boxes will be provided at a maximum spacing of 1,000 feet with at least one call box located strategically between all path access points and at all underpasses. Other safety features include removable bollards with locks at all vehicle access points, which prohibits unauthorized vehicles from accessing the community path and 1-foot-wide shoulders with either guard rail or railings with a rub rail to keep cyclists and emergency responder vehicles from veering too close to the track-side edge of the path.

The GLX Constructors Civil Infrastructure and Structural Guideway Team coordination efforts will be critical to every discipline providing wayside elements. GLX Constructors has been organized as a fully integrated design build team in order to share critical design information. Our guideway design provides the operational flexibility afforded by the constrained corridor while maintaining rider comfort and convenience. Safety is paramount to us and to the MBTA, so systems maintenance activities to support rider safety will be well-thought throughout and coordinated from design to revenue operations.

While the guideway connects to all communities of Boston, the community path unites the local surrounding communities. The path will create a direct route between the Magoun Square and the Washington Street/East Somerville areas for commuters and recreational users. The community path will be a safe and comfortable route in a congested urban setting. It will provide another means of transit and access for residents and visitors to connect to existing local businesses and other community amenities, such as the Somerville YMCA, City Offices, and the High School – all in close proximity to the School Street connection or the Hoyt-Sullivan Playground.

“**Wayside element coordination has already begun and will continue through construction. These elements include stations; VMF yard and building; TPSS sites and buildings; bridges and viaducts; utilities, including OCS and signal structures; community path; ROW access; and maintenance road requirements.**”

ITP Request	RFP		
	Drawing Number	Drawing Title	Reference Section or Drawing
A5.2.6.B.1	C-001 to C-057	Titles included on the Attached Drawings	
A5.2.6.B.2	C-003 to C-024; C-026 to C-032; C-033 to C-049, C-053 to C-055		
A5.2.6.B.3	C-001 to C-002; C-025		4.1(SYS-005 and SYS-006)
A5.2.6.B.4	C-001 to C-002; C-025		
A5.2.6.C.1	C-001 to C-057		
A5.2.6.C.2	C-003 to C-024; C-026 to C-032; C-033 to C-049, C-053 to C-055		

Technical Solutions Drawing Matrix.