

**MASSACHUSETTS  
BAY  
TRANSPORTATION  
AUTHORITY**

**RAILROAD OPERATIONS**

---

**COMMUTER RAIL  
DESIGN STANDARDS MANUAL**

**VOLUME I  
SECTION II**

**STATIONS AND PARKING**

---

**Revision No. 1  
April 19, 1996**

**TABLE OF CONTENTS**

**SECTION II - STATIONS AND PARKING**

<u>Chapter</u>	<u>Revision</u>	<u>Page</u>
<b>1. CIRCULATION AND PARKING</b>	<b>Rev.1</b>	<b>4-19-96</b>
I. INTRODUCTION		1.1
II. DESIGN OBJECTIVES		1.1
III. DESIGN GUIDELINES		1.1
A. Separation of Circulation Modes		1.1
B. Arrival/Departure Modes		1.1
C. Pedestrian Circulation		1.2
1. General Principles		1.2
2. Walkways		1.2
3. Crosswalks		1.3
4. Ramps		1.6
5. Stairs		1.9
6. Pedestrian Guard Rails		1.12
7. Track Crossings		1.12
a. Location		1.12
b. Grade level crossings		1.13
c. Grade separated crossings		1.15
D. Vehicular Circulation		1.16
1. General Principles		1.16
2. Vehicle Turning Radii		1.16
3. Standard Road Dimensions and Gradients		1.21
4. Vehicle Entrances and Exits		1.21
5. Drop-off/Pick-up Areas (Passenger Loading Zones)		1.23
E. Parking Lot Layout		1.25
1. General Principles		1.25
2. Parking Layout		1.25
a. Bay Orientation		1.25
b. Parking Stall Orientation		1.25
c. Perimeter Parking		1.25

<u>Chapter</u>	<u>Revision</u>	<u>Page</u>
3.	Dimensional Guidelines	1.26
	a. General notes	1.26
	b. Standards for 90 degree parking & physically disabled	1.26
	c. Standards for parallel parking on surface lots	1.26
4.	Accessible Parking	1.29
5.	Gradients	1.30
6.	Clearances	1.30
7.	Pedestrian and Traffic Islands	1.32
F.	Use of Landscape Buffers	1.32
G.	Use of Barriers	1.32
	1. General statement	1.32
	2. Types of Barriers	1.32
	a. Curbing	1.32
	b. Vehicular Guard Rail	1.33
	c. Bollards	1.33
	d. Pipe Rail	1.33
	e. Fencing	1.33
	f. Inter-track Fencing	1.34
H.	Parking Area Drainage Requirements	1.34
I.	Parking Fee Collection	1.34
IV.	REFERENCE STANDARDS	1.37
V.	PREFERRED MATERIALS	1.37
	A. Paving Materials	1.37
	B. Curbing Materials	1.37
	C. Barriers	1.37
	D. Striping Materials	1.38
<b>2.</b>	<b>CANOPIES AND PLATFORMS</b>	<b>Rev.1      4-19-96</b>
I.	INTRODUCTION	2.1
II.	DESIGN OBJECTIVES	2.1
III.	DESIGN GUIDELINES	2.1
	A. Platforms	2.1
	1. Location	2.1
	2. Safety	2.2

<u>Chapter</u>	<u>Revision</u>	<u>Page</u>
3. Efficiency		2.2
4. Use of Barriers		2.4
B. Shelters		2.5
1. General		2.5
2. Location		2.5
3. Conveniences		2.5
4. Lighting		2.5
C. Accessibility for Shelters and Platforms		2.5
IV DIMENSIONAL GUIDELINES		2.6
A. Platforms		2.6
1. Elevation		2.6
2. Length		2.6
3. Width		2.7
4. Gradient		2.8
5. Warning Stripe		2.8
B. Shelters		2.8
1. Size		2.8
2. Minimum Clearances		2.8
V. DESIGN CRITERIA AND DETAILS		2.10
A. Platform		2.10
1. Paving Materials		2.10
2. Platform Curving with Tactile Warning		2.10
3. Barriers		2.12
B. Shelters		2.12
3. LIGHTING	Rev. 1	4-19-96
I. INTRODUCTION		3.1
II. DESIGN OBJECTIVES		3.1
A. Security		3.1
B. Emphasis		3.1
C. Visual Comfort		3.1
D. Compatibility with Surrounding Uses		3.2
E. Efficiency		3.2
F. Attractiveness		3.2

<u>Chapter</u>	<u>Revision</u>	<u>Page</u>
III. DESIGN GUIDELINES		3.2
A. Illumination Levels		3.2
B. Optical Considerations		3.3
1. Contrast Levels		3.3
2. Glare		3.3
3. Reflected Glare		3.3
4. Methods of Control		3.3
C. Emphasis of Hazardous and Transition Areas		3.3
D. Emergency Lighting		3.5
IV. DESIGN CRITERIA AND DETAILS		3.5
A. General Luminaries Selection Criteria		3.5
B. General Lamp Selection Criteria		3.5
C. Wiring		3.8
D. Control Components		3.8
E. Fixture Mounting and Location		3.10
4. GRAPHICS	Rev. 1	4-19-96
I. INTRODUCTION		4.1
II. DESIGN OBJECTIVES		4.1
A. User Convenience		4.1
B. Consistency		4.1
C. Durability		4.1
III. DESIGN GUIDELINES		4.1
A. Terminology		4.1
1. General		4.1
2. Authority Name		4.1
3. Authority Symbol		4.2
4. Platform Information		4.2
5. Other Standard Terminology		4.2
6. Grammatical Guidelines		4.3
7. Punctuation Guidelines		4.3
8. Abbreviation Guidelines		4.4
B. Pictographs		4.4
C. Cartography		4.4

<u>Chapter</u>	<u>Revision</u>	<u>Page</u>
D.	Sign Types	4.5
1.	General	4.5
2.	Identification Signs	4.5
	a. General	4.5
	b. System Identification Sign	4.5
	c. Station Identification Sign	4.5
	d. Track Number/Destination Sign	4.6
	e. On-Site Identification Signs	4.6
3.	Directional Signs	4.6
	a. General	4.6
	b. Trailblazers	4.7
	c. On-Site Directional Signs	4.7
4.	Regulatory/Warning Signs	4.7
	a. General	4.7
	b. "Look Before Crossing" Sign	4.7
	c. "No Parking" Sign	4.8
	d. "No Smoking" Sign	4.8
5.	System Use Signs	4.8
	a. General	4.8
	b. System Panel Map	4.8
	c. Schedule Panel	4.9
IV.	DESIGN CRITERIA AND DETAILS	4.10
A.	General	4.10
B.	Typography	4.10
C.	Accessible Features	4.12
1.	General Requirements	4.12
	a. Character Proportion	4.12
	b. Character Height	4.12
	c. Finish and Contrast	4.12
2.	ADA Sign Types	4.12
	a. Tactile/Braille signs	4.12
	b. Station Identification Signs	4.12
	c. Directional Signs	4.12
	d. Variable Message Signs	4.12
	e. Miscellaneous Signs	4.12

<u>Chapter</u>	<u>Revision</u>	<u>Page</u>
D.	Symbol, Arrow and Pictographs	4.12
1.	Authority "T" Symbol	4.12
2.	Directional Arrow Symbol	4.13
3.	Pictographs	4.13
E.	Use of Color	4.13
1.	Reference to <u>Authority's Manual of Guidelines and Standards.</u>	4.13
2.	Maximum of five colors to be used	4.13
3.	Use black letters and symbols on white background for most directional and information signs	4.13
4.	Purple	4.13
5.	Red	4.21
6.	Yellow	4.21
7.	Blue	4.21
F.	Sign Layout	4.22
1.	General	4.22
2.	Identification Signs	4.22
a.	"T" Symbol	4.22
b.	Station Identification Sign	4.22
c.	Other Identification Signs	4.28
3.	Directional Signs	4.28
a.	Trailblazer	4.28
b.	Other Directional Signs	4.28
c.	Left justify all copy on signs away from platform	4.28
4.	Regulatory/Warning Signs	4.28
5.	System Use	4.28
G.	Sign Materials and Methods of Construction	4.35
1.	Fiberglass	4.35
2.	Sheet Aluminum	4.35
3.	Galvanized Steel	4.35

<u>Chapter</u>	<u>Revision</u>	<u>Page</u>
<b>5. COMFORT AND CONVENIENCE FACILITIES</b>	<b>Rev.1 4-19-96</b>	
I. INTRODUCTION		5.1
II. DESIGN OBJECTIVES		5.1
A. Comfort		5.1
B. Convenience		5.1
III. DESIGN GUIDELINES		5.1
A. General		5.1
B. Seating		5.1
1. General		5.1
2. Capacity Guidelines		5.1
3. Location Guidelines		5.2
C. Telephones		5.2
D. Trash Receptacles		5.3
E. Vending Machines and Concessions		5.3
F. Clocks		5.4
G. Toilet Facilities		5.4
IV. DESIGN CRITERIA AND DETAILS		5.5
A. Seating		5.5
B. Telephones		5.5
C. Trash Receptacles		5.7
D. Toilet Facilities		5.7
<b>6. LANDSCAPING</b>	<b>Rev. 1 4-19-96</b>	
I. INTRODUCTION		6.1
II. DESIGN OBJECTIVES		6.1
A. Attractiveness		6.1
B. Safety and Security		6.1
C. Preservation		6.1
D. Durability/Maintainability		6.1
E. Soil Conservation		6.1
III. DESIGN GUIDELINES		6.2
A. General		6.2
B. Buffers		6.2
1. General		6.2
2. Types of Buffers		6.2



a.	Site Topography	6.2
b.	Earth Berms	6.2
c.	Planting	6.2
d.	Fencing	6.2
3.	EPA noise guidelines	6.4
4.	Two approaches to alleviating noise impacts	6.4
a.	Berms and walls	6.4
b.	Visual screening	6.4
5.	Location Guidelines	6.4
C.	Site Drainage	6.5
1.	General	6.5
2.	Station Improvements create need for drainage	6.5
3.	Grade Modification Guidelines	6.5
4.	Drainage of Paved Areas	6.5
a.	General	6.5
b.	Minimum and Maximum Slopes	6.5
c.	Design Flows	6.6
d.	Storm Frequency Determination	6.6
e.	Hydraulics	6.6
f.	Gravity Flow	6.6
g.	Water Collection	6.6
5.	Drainage of Unpaved Areas	6.7
D.	Planting	6.8
1.	General	6.8
2.	Preserve Existing Natural Features	6.8
3.	Types of Planting	6.9
4.	Location of Planting	6.9
IV.	DESIGN CRITERIA AND DETAILS	6.12
A.	General	6.12
B.	Site Drainage	6.12
1.	Materials	6.12
2.	Storm Drainage Pipe	6.12
3.	Manholes, Basins and Inlets	6.12
C.	Planting	6.13
1.	General	6.13
2.	Plant Types	6.13
a.	Large trees	6.13
b.	Small trees	6.13

<u>Chapter</u>	<u>Revision</u>	<u>Page</u>
	c. Evergreen trees	6.13
	d. Shrubs	6.13
	e. Ground cover	6.13
3.	Station Areas for Planting	6.15
4.	Matrix of Preferred Size and Location of Plantings	6.15
5.	Planting Requirements	6.15
6.	Tree Grates	6.16

---

**CHAPTER 1**  
**CIRCULATION AND PARKING**

**I. INTRODUCTION**

Design standards for vehicular and pedestrian circulation and parking facilities at commuter rail stations are addressed in this section. The guidelines contained herein are intended to direct design consultants in the development of plans and details that will conform to the Authority's current goals for commuter rail station design. These guidelines include design criteria for roadways, walkways, stairs, ramps, and parking lots. Current State and Federal rules, regulations and standards for accessibility are applicable to commuter rail station facilities. (Refer also to the MBTA Guide to Access).

It should be emphasized that these standards are not exhaustive and will leave many site specific issues unaddressed. It is the design consultant's responsibility to seek direction from the Authority where situations arise not covered by these guidelines. Further, it is the responsibility of the design consultant to review the latest applicable Federal, State, and local regulations. Where conflict may exist between such regulations, these guidelines, and/or the MBTA Guide to Access, the most stringent shall apply.

**II. DESIGN OBJECTIVES**

Safety, efficiency, and accessibility are the principal objectives to consider in the design of circulation and parking facilities at commuter stations. The organization and detail of the station design must also address specific issues of security, maintenance, and snow removal.

**III. DESIGN GUIDELINES**

**A. Separation of Circulation Modes**

For the maximization of safety station site circulation modes of pedestrian, vehicular, and rail movements should be separately delineated. Locations where circulation modes cross or interface must be well identified and sight lines maximized.

**B. Arrival/Departure Modes**

Station design must address the variety of arrival/departure modes:

- o Pedestrian walk-in and bicycles
- o Public transportation, including taxis
- o Drop-off/pick-up
- o Park and ride

Pedestrian, public transportation, and drop-off/pick-up modes should be encouraged by minimizing walking distances from site entry points, and curbside stops to the platform.

 Massachusetts Bay Transportation Authority <b>RAILROAD OPERATIONS</b>	<b>Commuter Rail Design Standards Manual</b>	Stations and Parking	Section II
		<b>Circulation and Parking</b>	Chapter 1
Revision No. 1	Date: 4/19/96	Page 1.1	

**C. Pedestrian Circulation**

**1. General Principles**

- a. Pedestrian pathways should be direct, well defined, and provide a clear indication of where they lead.
- b. Pedestrian access from the surrounding community should be encouraged by providing a direct, paved walkway to the platforms.
- c. An accessible route of travel, free from steps, must link the accessible station entrance with public sidewalks, bus stops, parking and passenger loading zones. The platform may be considered to be a part of this accessible entrance route. With exceptions allowing for specific site conditions, this accessible route of travel should be the primary route for all station users.

**2. Walkways**

**Note:**

The following section represents a partial summary of the design constraints for walkways. Consult the MBTA Guide to Access and relevant codes for additional information.

- a. Width:           5'-0" preferred minimum  
                  4'-0" absolute minimum

**Notes:**

- 1. For widths less than 5'-0", provide 5'-0" by 5'-0" passing spaces at intervals not to exceed 200'-0".
- 2. Subject to Authority approval and code compliance, the clear width of an accessible route may be a minimum of 36" excluding curb stones and 32" at columns or other obstructions having a depth less than 24".

- b. Slope in the                   5% (approx. 5/8" per foot)  
direction of travel:       absolute maximum

**Note:**

If the slope is greater than 5%, it must be treated as a ramp with a maximum slope of 8%.

Cross-slope:                   2% maximum

- c. No level change greater than 1/2" is permitted unless a ramp is provided. Level changes between 1/4" and 1/2" must be beveled with a maximum slope of 1:2.
- d. Walkway surfaces must be slip-resistant (minimum static coefficient of friction of 0.6) with all joints finished flush.

 Massachusetts Bay Transportation Authority <b>RAILROAD OPERATIONS</b>	<b>Commuter Rail Design Standards Manual</b>	Stations and Parking	Section II
		<b>Circulation and Parking</b>	Chapter 1
Revision No. 1	Date: 4/19/96	Page 1.2	

- e. Walkways adjacent to roadways should be physically separated by curbing, guardrail, or bollards for safety and to prevent encroachment by vehicles.

**Note:**

The use of bollards should be minimized as they may interfere with snow removal.

- f. Where sidewalks are located immediately adjacent to parking areas, vehicle overhang from 90° or angle parking should be accounted for in the layout of walkways to ensure that required sidewalk width is maintained.
- g. Snow removal and storage must be considered in the location and design of sidewalks.
- h. Sidewalk shall not be utilized simply as a design element, such as an edge treatment along a roadway. Minimize the amount of sidewalk to that which is truly required.

**3. Crosswalks**

- a. Locate crosswalks to maximize visibility between pedestrians and vehicles.
- b. Width: Equal to or wider than walkway width.  
(6'-0" minimum)  
Curb cuts at marked crossings must be wholly within the crossing markings (excluding flared sides).
- c. Pedestrian roadway crossings should be defined by white warning stripes painted on the surface of the roadway (See diagram following).
- d. Curb cuts must be provided wherever an accessible route crosses a curb. The preferred minimum width of curb cuts shall be 40" (absolute minimum no less than 36"), not including sloped sides. The maximum slope of the curb ramp shall be 1:12.
- e. Curb cut ramps must be installed perpendicular to the curbs. Diagonal curb cuts are not allowed.

**Note:**

Consult the MBTA Guide to Access for additional information on the location and design of curb cuts.

 Massachusetts Bay Transportation Authority <b>RAILROAD OPERATIONS</b>	<b>Commuter Rail Design Standards Manual</b>	Stations and Parking <span style="float: right;">Section II</span>
		<b>Circulation and Parking</b> <span style="float: right;">Chapter 1</span> <span style="float: right;">Page 1.3</span>
Revision No. 1	Date: 4/19/96	

Typical Marking of Pedestrian Roadway Crossing

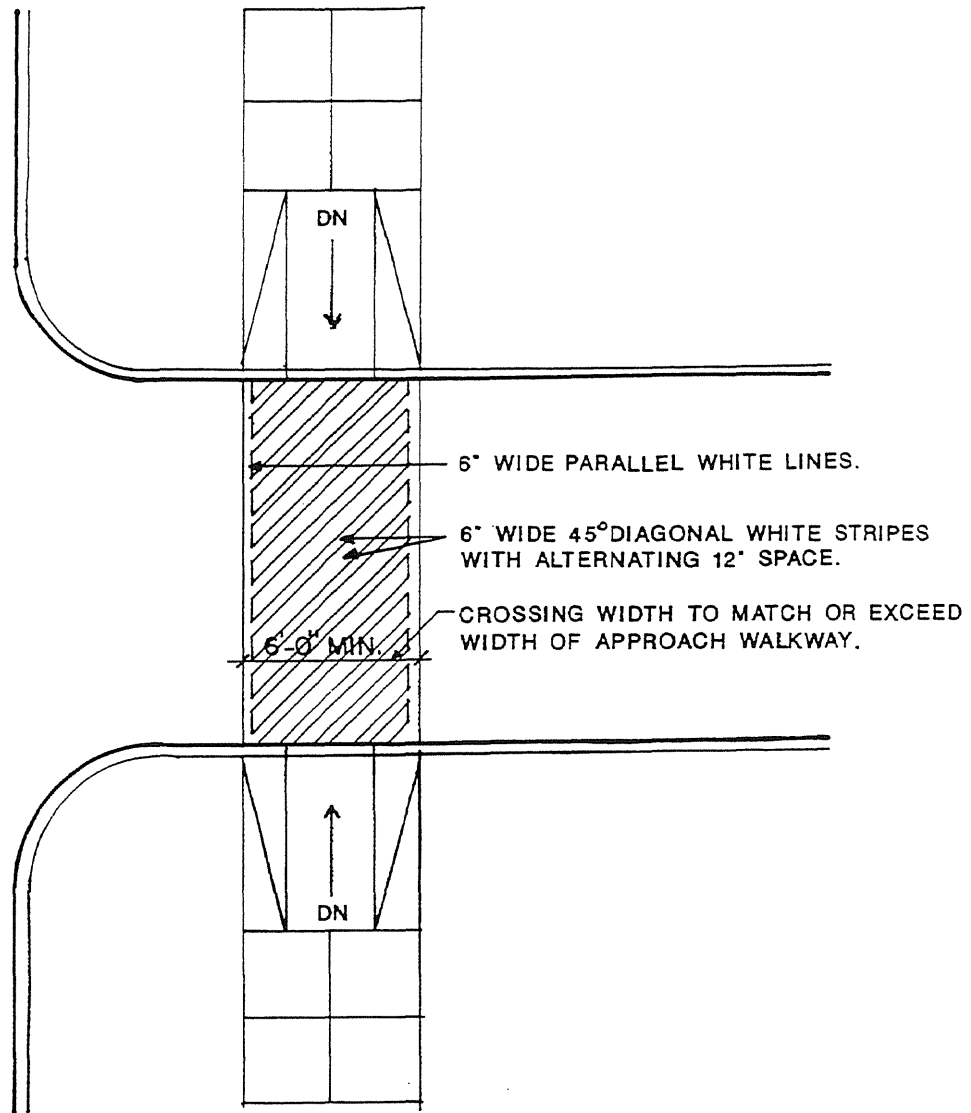

 <p>Massachusetts Bay Transportation Authority</p> <p>RAILROAD OPERATIONS</p>	<p>Commuter Rail Design Standards Manual</p>	<p>Stations and Parking</p>	<p>Section II</p>
		<p><b>Circulation and Parking</b></p>	<p>Chapter 1</p>
<p>Revision No. 1</p>	<p>Date: 4/19/96</p>	<p>Page 1.4</p>	

Typical Curb Cut

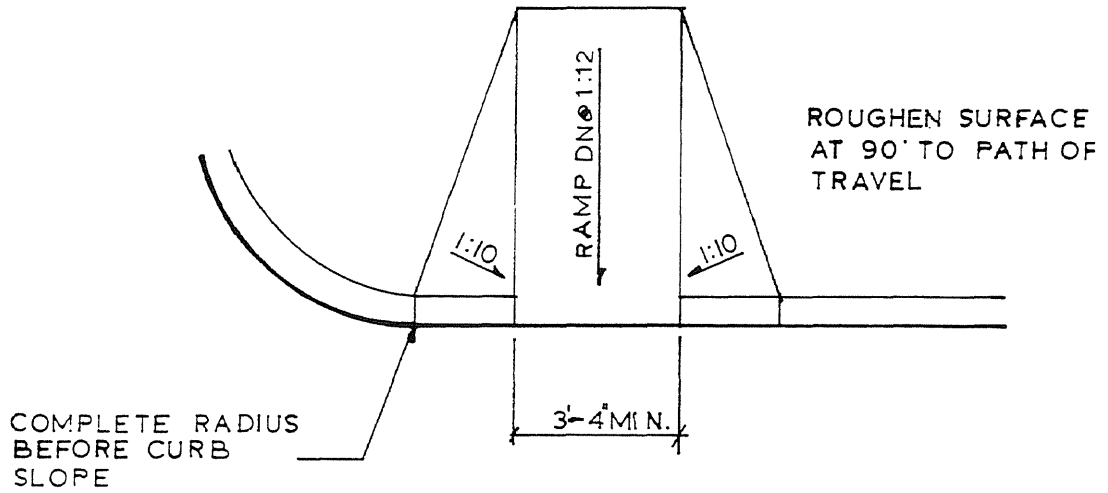

Curb Cut in Narrow Sidewalk

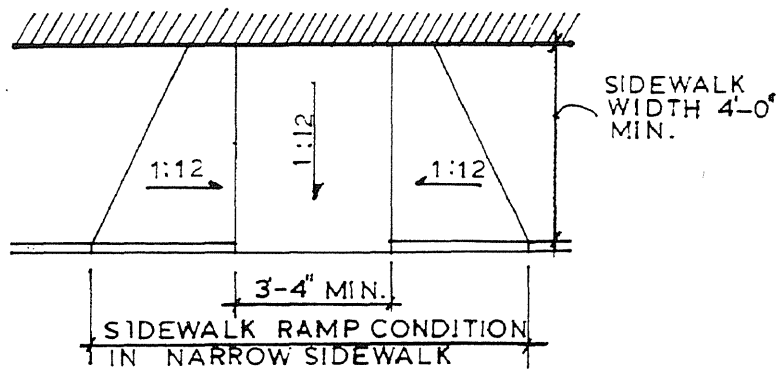



4. Ramps

Note:

The following section represents a partial summary of the design requirements for ramps. Consult the MBTA Guide to Access and applicable Federal and State codes for additional information.

- a. Width: 4'-0" absolute minimum  
(measured from inside to inside of railing)
- b. Slope: 8% maximum  
(1" rise in 12.5" run)

Note:

Ramps shall have a cross slope that is 1:50 (2%) or less.

- c. Distance between landings: 30'-0" maximum
- d. Length of Landings: Equal to width of ramp  
(5'-0" minimum length)

Note:

Where a ramp changes direction the landing should be at least 5'-0" by 5'-0". Adequate drainage must be provided to prevent ponding of water at landings.

- e. Provide a level area that is 5'-0" in length and equal to the width of the ramp (2% maximum slope in either direction) at the top and bottom of each ramp.
- f. Ramps shall have a slip-resistant (minimum static coefficient of friction of 0.8) and a glare-free surface.
- g. Run-off is the clear area between the end of a stair or ramp and the nearest obstruction conflicting with pedestrian movement.
  - (1) The run-off to an obstruction such as a wall, kiosk, or pier should be equal to 1.7 times the width of the ramp.
  - (2) The run-off to the edge of a queuing space, such as the front edge of a platform, should be at least 10'-0".
- h. Ramps and landings with drop-offs shall have curbs, walls, railings or projecting surfaces that prevent people and wheel chairs from slipping off the ramp. Curbs shall be a minimum of 2" high. Protective railings shall allow a maximum 2" vertical gap above the ramp surface. Projecting surfaces must extend a minimum of 12" beyond the outside of the guard/hand rail.
- i. Handrails at ramps:
  - (1) Provide continuous handrails on both sides of all ramps.

 Massachusetts Bay Transportation Authority <b>RAILROAD OPERATIONS</b>	<b>Commuter Rail Design Standards Manual</b>	Stations and Parking	Section II
		<b>Circulation and Parking</b>	Chapter 1
Revision No. 1	Date: 4/19/96	Page 1.6	

(2) Heights: 2'-10" and 1'-7"  
(measured vertically from the ramp surface)

(3) Extension: 1'-0" minimum

**Note:**

Handrail should extend beyond top and bottom of ramp, return to a wall or post and must be parallel to ground surface.

(4) Handgrip: Not less than 1 1/4"  
Not more than 1 1/2"  
(outside diameter)

**Note:**

Handgrip should be round or oval in cross-section, should have a smooth surface with no sharp corners, and should be uninterrupted for its entire length to provide a continuous gripping surface.

(5) Handgrip Clearance: 1 1/2"  
(measured between wall and the wall-side face of the handgrip)

k. Where there is a vertical drop at the side of a ramp, provide pedestrian guardrail. (Refer to paragraph 6. Pedestrian Guardrails.)

Ramp Landings

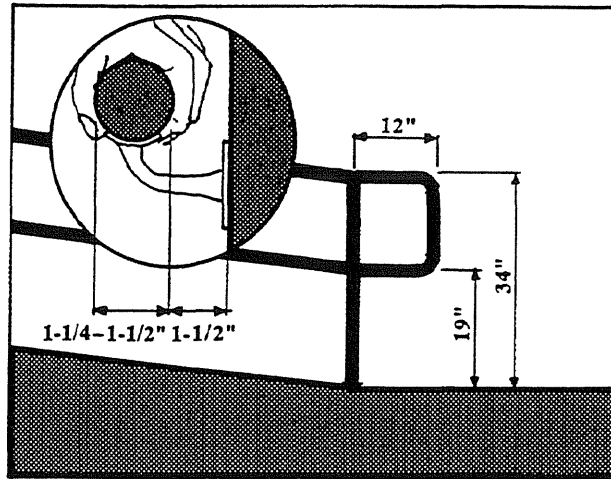

Ramp Handrails with Extensions

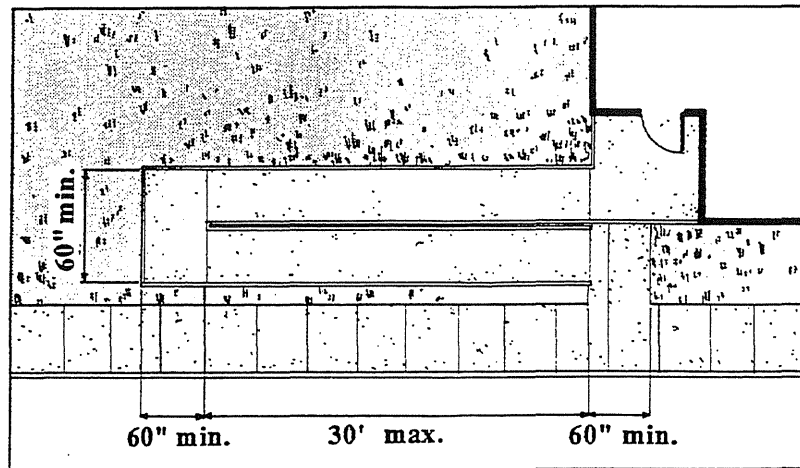

5. Stairs

Note:

The following section represents a partial summary of the design constraints for stairs. Consult the MBTA Guide to Access and relevant codes for additional information.)

- a. Width:       6'-0" preferred minimum  
              4'-0" absolute minimum
- b. Landings:   Every 12'-0" of vertical rise  
  
      Length:    Equal to width of stair  
                  (4'-6" absolute minimum)
- c. Riser Size:  6" < R < 7"  
                  ("<" = less than)

Tread Size: 11" < T < 13"

Note:

These standards represent extremes; riser-tread ratios should be calculated using the following formula:

$$2R + T = 25"$$

The treads and risers of any stair must be of a uniform dimension. The minimum number of risers for any stair is three, and the risers themselves should be closed. Stair treads shall not have an abrupt projection of nosing.

- d. Slope of riser:  1 1/4" maximum  
                  (measured from the horizontal projection of  
                  the tread below)  
      Riser to tread angle:  Greater than 70 degrees  
                  (See diagram)
- e. Stair treads should pitch to avoid ponding of water (a maximum of 1/8" per foot).
- f. Stair treads shall have a slip-resistant (minimum static coefficient of friction of 0.6), glare-free surface.
- g. Handrails at stairs:
  - (1) Provide continuous (not interrupted by newel posts or other obstructions) handrails on both sides of all stairs. When stairs are greater than 7'-4" in width, intermediate rails are required.
  - (2) Heights:       2'-10" and 1'-7"  
                  (measured vertically from nosing)

 Massachusetts Bay Transportation Authority <b>RAILROAD OPERATIONS</b>	<b>Commuter Rail Design Standards Manual</b>	Stations and Parking                      Section II
		<b>Circulation and Parking</b> Chapter 1 <div style="text-align: right;">Page 1.9</div>
Revision No. 1	Date: 4/19/96	

- (3) Extension: 1'-0" minimum (top)  
 1'-0" minimum + length of one tread (bottom)

**Note:**

At the top, the extension shall be parallel to the walking surface; at the bottom, the handrail shall continue to slope for the distance of the width of one tread, then shall be parallel to the walking surface. Both handrail extensions should return to a wall or post.

Handrail extensions are not require if they would impede travel or create a hazard on the landing.

- (4) Handgrip: Not less than 1 1/4"  
 Not more than 1 1/2"  
 (outside diameter)

**Note:**

Handgrip should be round or oval in cross-section, should have a smooth surface with no sharp corners, and should be uninterrupted for its entire length to provide a continuous gripping surface.

- (5) Handgrip Clearance: 1 1/2"  
 (measured between wall and the wall-side face of the handgrip)

 Massachusetts Bay Transportation Authority <b>RAILROAD OPERATIONS</b>	<b>Commuter Rail Design Standards Manual</b>	Stations and Parking	Section II
		<b>Circulation and Parking</b>	Chapter 1
Revision No. 1	Date: 4/19/96	Page 1.10	

Stair Nosing

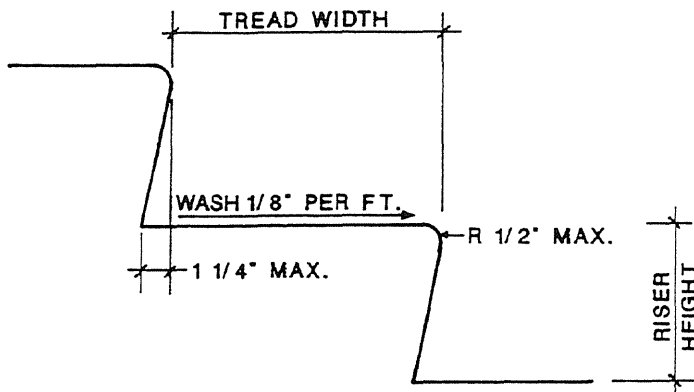

Stair Handrail with Extensions

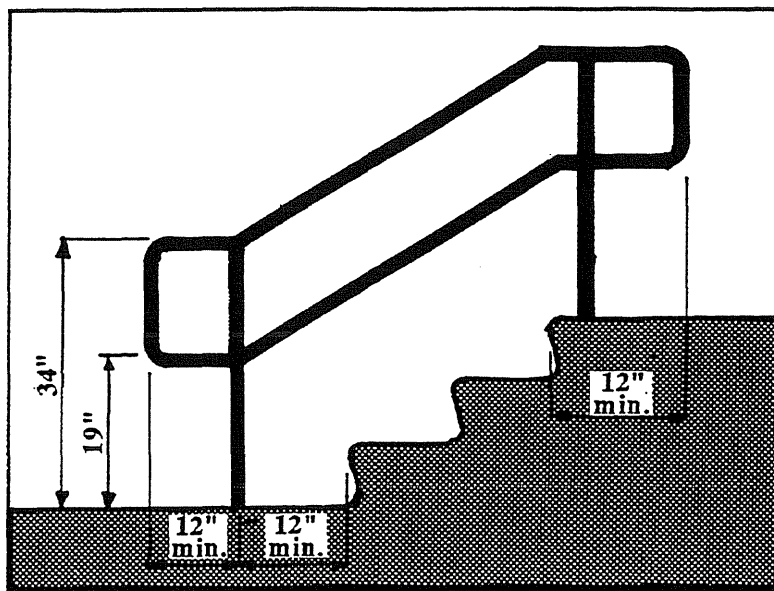

**6. Pedestrian Guardrails:**

**Note:**

The following section represents a partial summary of the design constraints for guardrails. Consult the MBTA Guide to Access and relevant codes for additional information.

- a. A pedestrian guardrail is a system of building components located on the open side of walking surfaces for the purpose of minimizing the possibility of an accidental fall from the walking surface to a lower level.
- b. Use pedestrian guardrails where required by applicable code and in the following situations:
  - (1) Where there is a direct vertical drop in excess of 4'-0" closer than 2'-0" to a walkway, parking area, or roadway.
  - (2) Along all open-sided walkways, mezzanines, and landings.
  - (3) Where there is a vertical drop at the side of a ramp or stair.
- c. Height: 3'-6" minimum  
(measured vertically the leading edge of the tread or from the top of the walking surface)
- d. Openings: 6" maximum opening
- e. Loading Requirements:
 

All required pedestrian guardrails shall be designed and constructed to meet the structural loading conditions set forth in the most recent edition of the Massachusetts State Building Code.
- f. Do not use unnecessary horizontal elements that may provide an easy surface for climbing.

**7. Track Crossings**

- a. The location and number of grade level pedestrian track crossings shall be determined on a site specific basis by the Authority.

**Note:**

Grade level crossings are not permitted at stations on high speed lines (speeds greater than 80 miles per hour).

 Massachusetts Bay Transportation Authority <b>RAILROAD OPERATIONS</b>	<b>Commuter Rail Design Standards Manual</b>	Stations and Parking	Section II
		<b>Circulation and Parking</b>	Chapter 1
Revision No. 1	Date: 4/19/96	Page 1.12	

b. Grade level crossings:

- (1) Pedestrian crossings should be located where pedestrian traffic is greatest. Grade level crossings should be offset from areas on the platform where the train doors are likely to align when trains are stopped for loading or disembarking passengers. Crossings should be located to be blocked when a train is stopped within the station to prevent pedestrian track crossings.
- (2) Grade level track crossings should be offset from access points to the platform. Design layout should seek to reduce the probability of pedestrians stepping out into the crossing without looking for on-coming trains.
- (3) Width: 8'-0" minimum
- (4) Slope in the direction of travel: 5% (approx. 5/8" per foot) absolute maximum  
 Cross Slope: 2% (approx. 1/4" per foot) absolute maximum

Note:

The above slopes apply to walking surfaces within the crossing. The platform should slope down at a maximum slope of one in twelve (1:12) to the level of the crossing to permit access for wheelchairs and maintenance vehicles.

No level change greater than 1/2" is permitted unless a ramp is provided. Level changes between 1/4" and 1/2" must be beveled with a maximum slope of 1:2.

- (6) The crossing surface should be slip-resistant (maximum static coefficient of friction should be 0.6 for walking surface and 0.8 for ramped surfaces). Material should be impervious to oil and grease.
- (7) The construction of pedestrian crossing construction should be 'panelized' for ease of removal for track maintenance.
- (8) The gap between rail and adjacent track crossing surfaces shall be governed by American Rail Engineer's Association standards and shall comply with State and Federal accessibility rules, regulations and standards. The maximum permissible gap at the inner edge of each rail is 2-1/2".
- (9) Detectable warning surfaces for persons with visual disabilities shall be provided at the edge of all track crossings.

 Massachusetts Bay Transportation Authority <b>RAILROAD OPERATIONS</b>	<b>Commuter Rail Design Standards Manual</b>	Stations and Parking	Section II
		<b>Circulation and Parking</b>	Chapter 1
Revision No. 1	Date: 4/19/96	Page 1.13	



- (10) Provide fully automated crossing warning systems at each pedestrian crossing on main line tracks. Secondary and other low speed tracks may be exempted from this requirement on a site specific basis. Locate warning signs on all crossings to be visible from each entry to the crossing. These signs should have the phrase "Look Before Crossing" on both sides. (See Chapter on "Graphics" for design criteria for the standard sign.)

**Pedestrian Track Crossing**

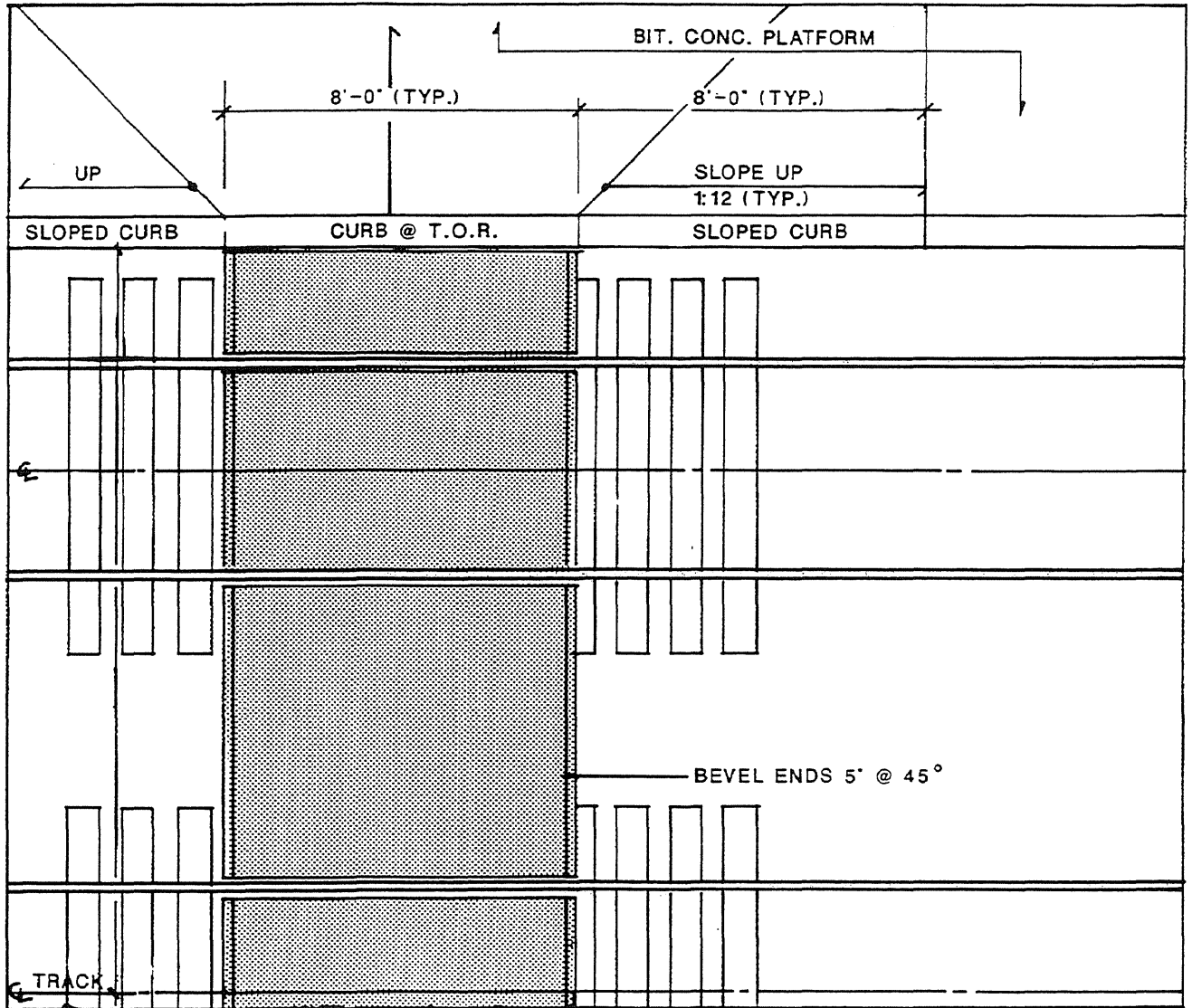

c. Grade separated crossings:

- (1) All new pedestrian crossings on the Providence line shall be grade separated.
- (2) Locate new grade separated crossings where pedestrian traffic is greatest--e.g. at the midpoint of platforms or at the point of access to/from parking. Reuse existing grade separated crossings where possible.
- (3) Width:                   6'-0" minimum  
                                  (open, elevated crossings)  
                                  12'-0" minimum (enclosed passageways,  
                                  tunnels)
- (4) Slope in the               5% (approx. 5/8" per foot)  
direction of travel:       absolute maximum  
  
Cross Slope:                2% (approx. 1/4" per foot)  
                                  absolute maximum
- (5) Grade separated structures must comply with rules and regulations governing accessibility. Access shall be provided by ramp or elevator.
- (6) All grade separated crossings shall be illuminated in accordance with the guidelines presented in Chapter "Lighting".
- (7) Elevated grade separated structures shall be enclosed with metal grating or fencing with a maximum openings of 1" between members as a means of preventing dropping or throwing debris at trains. Limit such protective enclosures to directly over the track area to facilitate snow removal.
- (8) Pedestrian bridges and associated ramps must be covered to protect against rain and the accumulation of snow on the walkway surfaces.

**D. Vehicular Circulation**

1. General Principles

- a. Provide the most direct roadway access possible between the entrance to the site and the drop-off/pick-up area.
- b. Where site conditions permit, vehicle access to the site should favor the inbound side.
- c. Provide convenient loop turn-arounds for drop-off/pick-up vehicles (buses, taxis, private automobiles).
- d. Roadways in public rights-of-way that are to be relocated or improved shall be designed to current standards set forth by the Massachusetts Department of Public Works and as required by local codes.

2. Vehicle Turning Radii

Note:  
The following table is taken from the 1990 edition of A Policy on the Geometric Design of Highways and Streets.

Design Vehicle	Minimum Turning Radius	Minimum Inside Radius	Minimum Turning Path
Passenger Car (P)	24	13.8	25.5
Single Unit Transit Bus (BUS)	42	24.4	46.5
Single Unit Truck (SU)	42	27.8	44.1
Semitrailer (WB 50)	45	19.2	46.3

Minimum Turning Paths of Typical Vehicles

The following diagrams are taken from  
A Policy on the Geometric Design of Highways and Streets, 1990 ed.

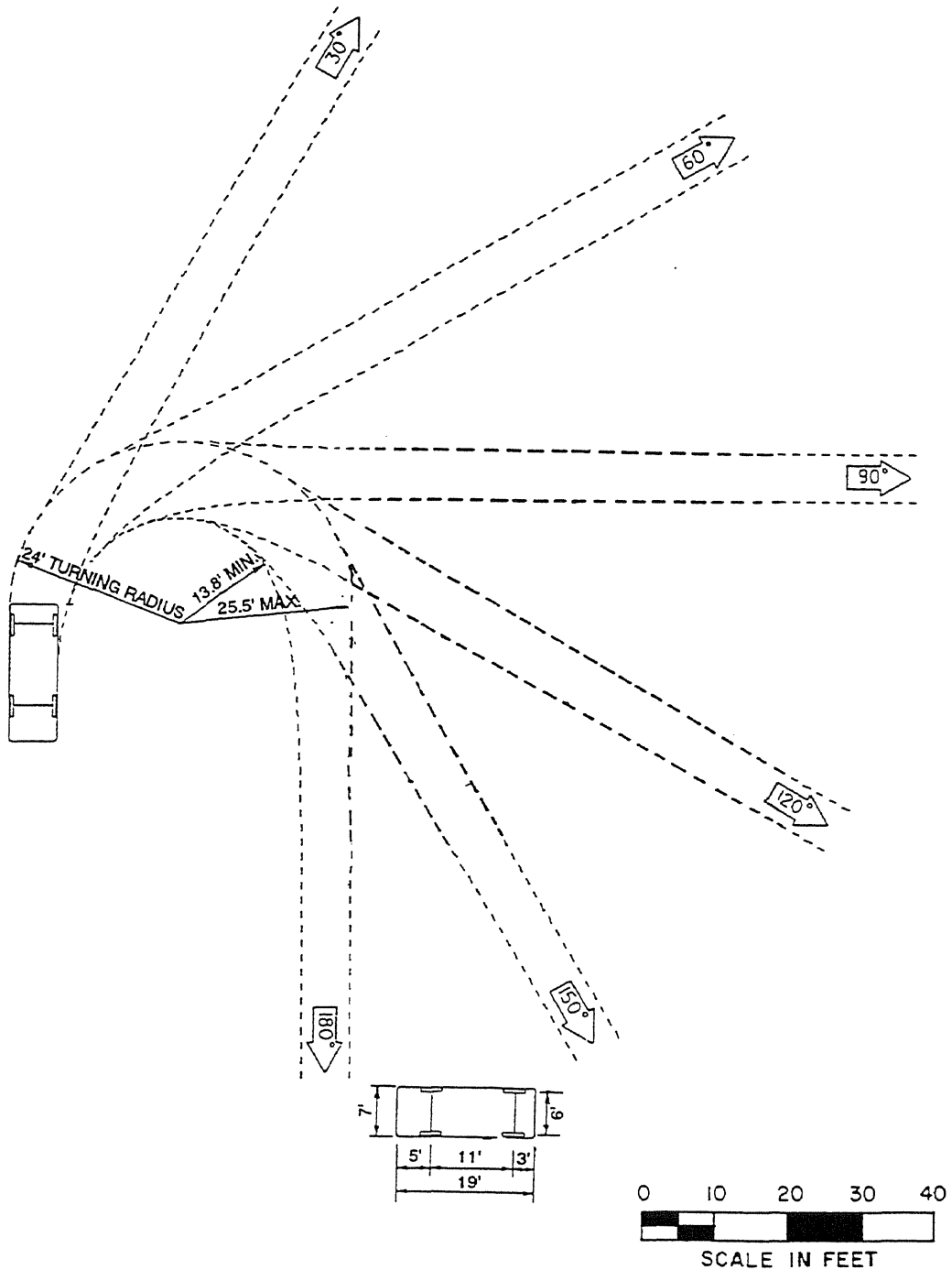

Minimum turning path for P design vehicle.

 Massachusetts Bay Transportation Authority <b>RAILROAD OPERATIONS</b>	Commuter Rail Design Standards Manual	Stations and Parking	Section II
		<b>Circulation and Parking</b>	Chapter 1
Revision No. 1	Date: 4/19/96	Page 1.17	

Minimum Turning Paths of Typical Vehicles

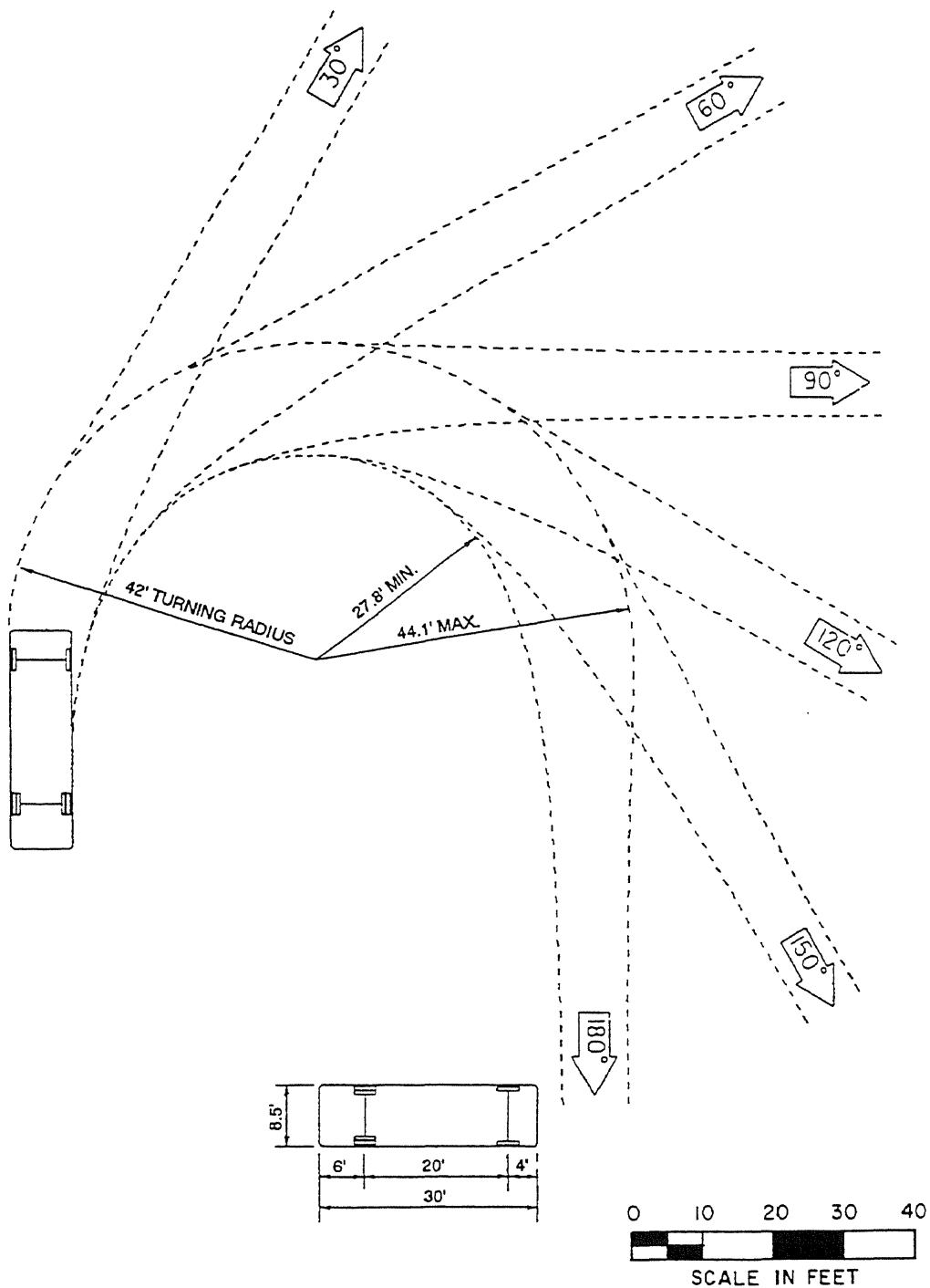

Minimum turning path for SU design vehicle.

 Massachusetts Bay Transportation Authority <b>RAILROAD OPERATIONS</b>	Commuter Rail Design Standards Manual	Stations and Parking	Section II
		<b>Circulation and Parking</b>	Chapter 1
Revision No. 1	Date: 4/19/96	Page 1.18	

Minimum Turning Paths of Typical Vehicles

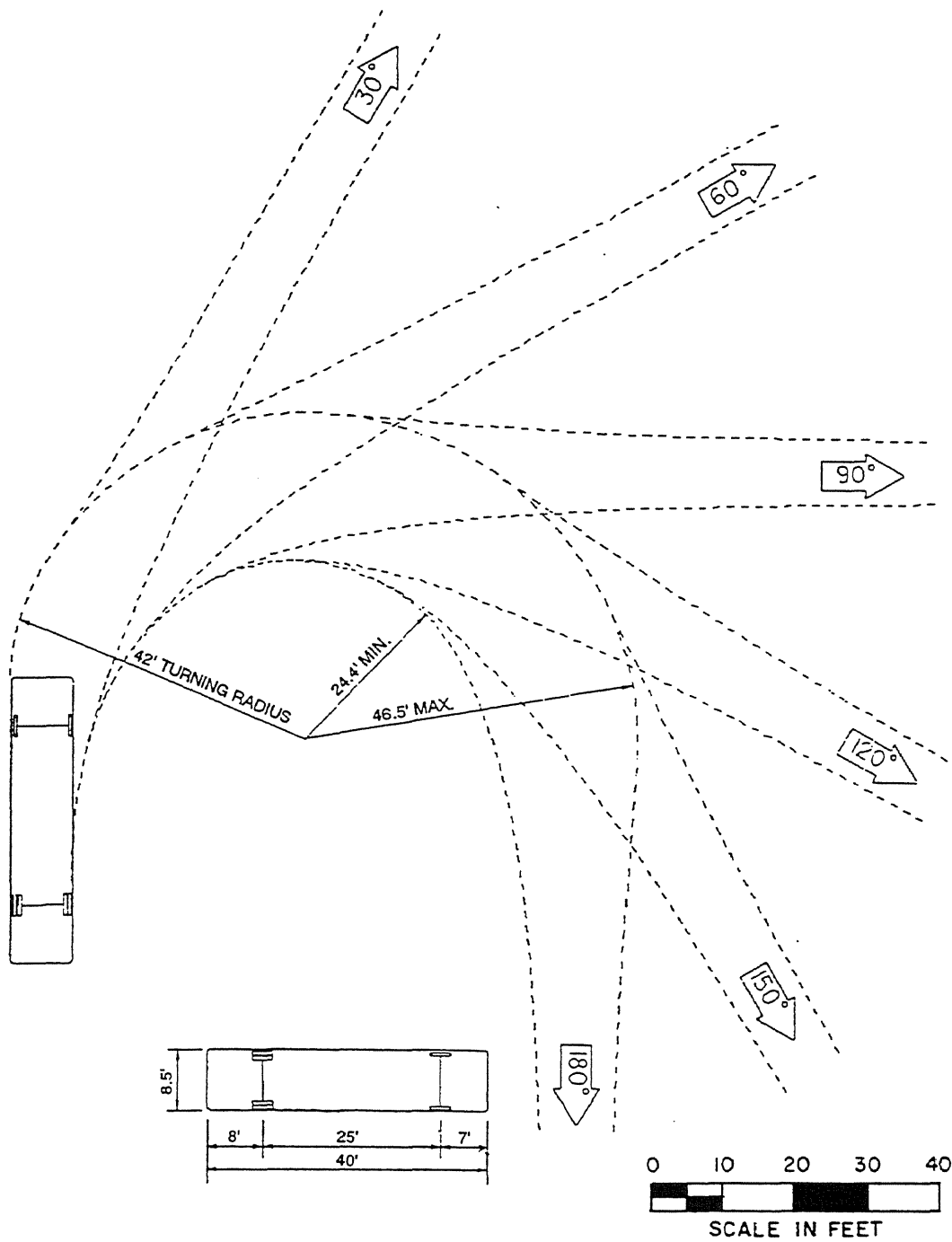

Minimum turning path for BUS design vehicle.

 Massachusetts Bay Transportation Authority <b>RAILROAD OPERATIONS</b>	Commuter Rail Design Standards Manual	Stations and Parking	Section II
		<b>Circulation and Parking</b>	Chapter 1
Revision No. 1	Date: 4/19/96	Page 1.19	

Minimum Turning Paths of Typical Vehicles

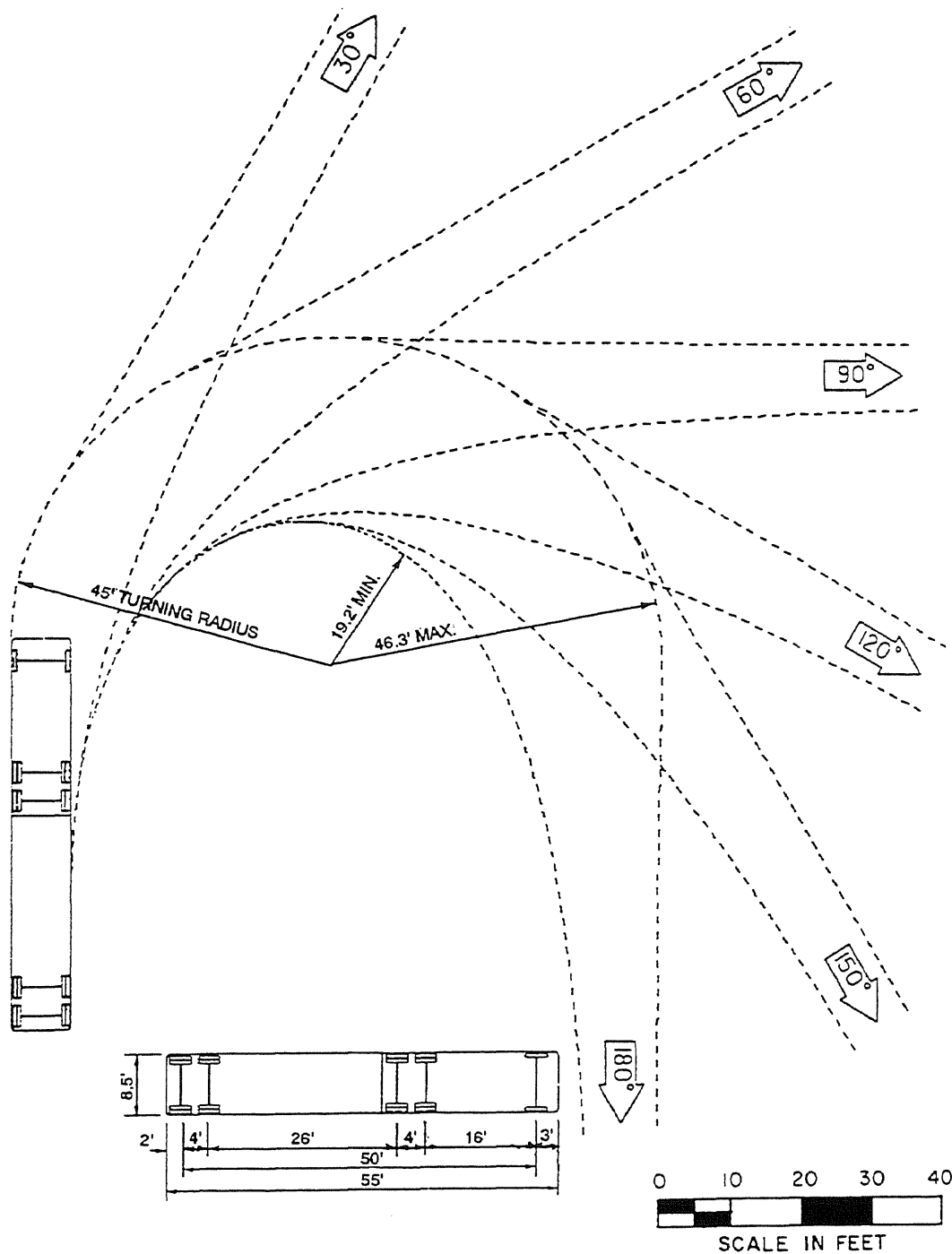

Minimum turning path for WB-50 design vehicle.

 <p>Massachusetts Bay Transportation Authority</p>	<p>Commuter Rail Design Standards Manual</p>	<p>Stations and Parking</p>	<p>Section II</p>
		<p><b>Circulation and Parking</b></p>	<p>Chapter 1</p>
<p>RAILROAD OPERATIONS</p>	<p>Revision No. 1</p>	<p>Date: 4/19/96</p>	<p>Page 1.20</p>

**3. Standard Roadway Dimensions and Gradients**

- a. The preferred minimum roadway lane width is 12'-0". The absolute minimum lane width is 10'-0". The absolute minimum lane width for a one-way single lane is 16'-0".
- b. Roadways shall be cross pitched to provide positive drainage. The preferred cross pitch is 2% (approx. 1/4" per foot). The absolute minimum cross pitch is 1% (approximately 1/8" per foot). The maximum cross pitch is 3% (approx. 3/8" per foot). Where possible, roadways should be crowned in the middle and drain to the edges.
- c. Roadway gradients:

Vehicle	Roadway Gradients (Slope)
Automobile	10% maximum (approx. 1 3/16" per foot) for ramps, access roadways, and driveways; 6% maximum (approx. 3/4" per foot) sustained grade for safe operation; 5% maximum (approx. 5/8" per foot) on roadways subject frequent ice, snow, sleet, and fog.
Bus	10% maximum (approx. 1 3/16" per foot) operating grade; 6.5% maximum (approx. 13/16" per foot) design grade--controlled by safety considerations and desirable operating conditions in the winter months.

- d. Where an accessible route crosses a roadway, the maximum allowable slope in the direction of travel is 5% with a maximum cross slope of 2%.

**4. Vehicle Entrances and Exits**

- a. The number and location of vehicle entrances and exits at a station is determined by many factors, including parking lot size, drop-off/pick-up volume, site topography, traffic volumes on adjacent streets, and adjacent land uses.



## Circulation and Parking

- b. The recommended distance between site entrances/exits and adjacent street intersections along various types of roadways is presented below:

Type of Roadway	Minimum Distance (ft)	Preferred Distance(ft)
Major Arterial	200	400
Minor Arterial	150	300
Collector/Local Street	100	200

- c. Entrance and Exit Design

- (1) At exits where a moderate number of left hand turns is anticipated, a second auxiliary exit lane should be considered to separate left and right hand turns. The preferred width of auxiliary lanes is 12'-0"; the minimum width is 10'-0". (See Diagram following.)
- (2) Vehicle storage length is the area required to accommodate vehicles exiting the site. This area should be separate from and not interfere with the operation of vehicles in the remainder of the parking lot.

- d. For further information on the design of intersections, auxiliary lanes and deceleration lanes, see A Policy on the Geometric Design of Highways and Streets, published by the American Association of State Highway and Transportation Officials.

Layout of Auxiliary and Deceleration Lanes

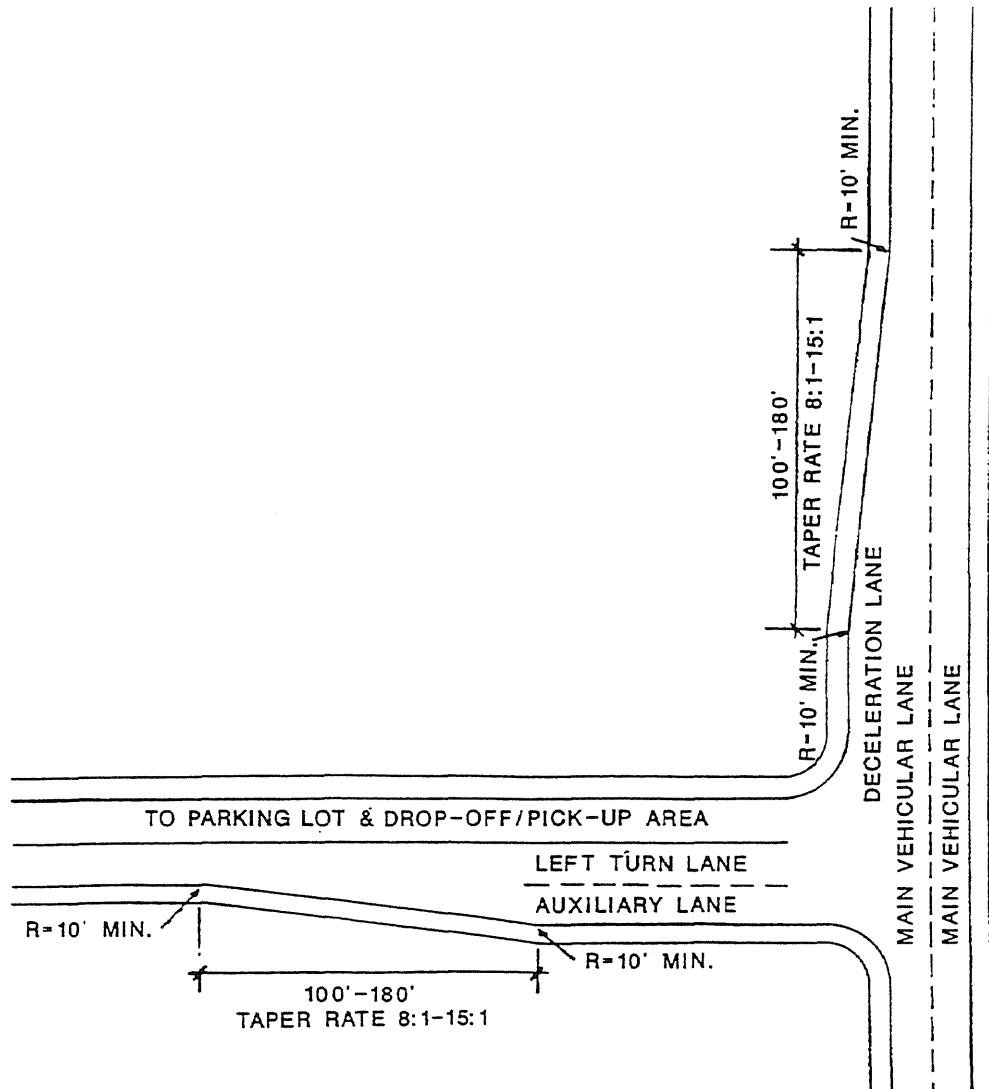

5. Drop-off/Pick-up Areas (Passenger Loading Zones)

- a. Provide drop-off/pick-up areas at all stations, even those sites where no long term parking is provided. Locate the drop-off/pick-up area within a maximum 100 feet of the station platform and ensure compliance with the Rules and Regulations of the Architectural Access Board (AAB) of the Commonwealth of Massachusetts. Accessible drop-off/pick-up areas shall be identified with international symbol of accessibility signs.

 Massachusetts Bay Transportation Authority <b>RAILROAD OPERATIONS</b>	Commuter Rail Design Standards Manual	Stations and Parking	Section II
		<b>Circulation and Parking</b>	Chapter 1
Revision No. 1	Date: 4/19/96	Page 1.23	

Note: As of the date of this writing, the requirement of the Americans with Disabilities Act Accessibility Guidelines (ADAAG) for tactile warning material at curb-side locations has been suspended.

b. Limit the size of drop-off/pick-up areas. Without strict enforcement of parking restrictions, all-day parkers will utilize drop-off/pick-up areas. Parking lot aisles can be used for queuing of vehicles waiting to pick up passengers.

c. Drop-off/Pick-up Area Layout:

(1) The drop-off area must be designed for accessibility, providing a 5'-0" wide aisle space between the vehicle and the curb over its full length. Provide curb cuts within the drop-off area.

Drop-off areas should be designed for right-hand curbside drop. (See Diagram)

(2) Where passengers transfer from local bus lines to commuter rail, a bus drop-off/pick-up area with a berth size of 80'-0" by 11'-0" should be provided.

At bus stops where a lift will be deployed:

- Provide firm, stable surface a minimum clear length of 96" measured from the curb or vehicle roadway.
- Provide minimum 60" clear width, measured parallel to vehicle and roadway.

Passenger Loading Zone

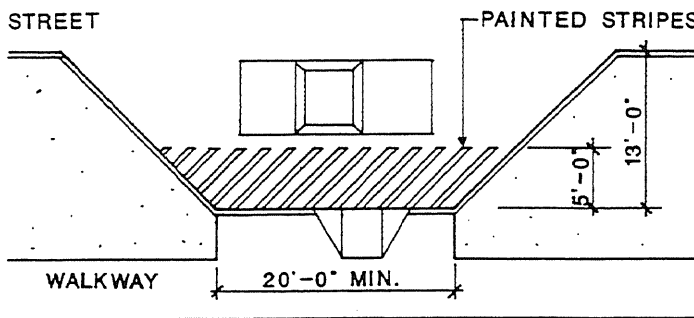

Passenger Loading Zone Without Curb

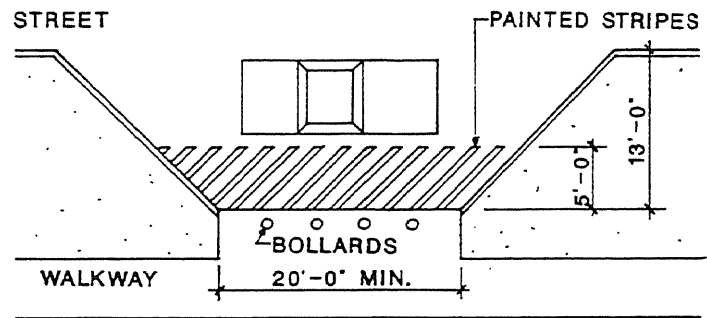

Passenger Loading Zone With Curb

 <p>Masachusetts Bay Transportation Authority</p> <p>RAILROAD OPERATIONS</p> <p>Revision No. 1      Date: 4/19/96</p>	<p>Commuter Rail Design Standards Manual</p>	<p>Stations and Parking      Section II</p>
		<p><b>Circulation and Parking</b>      Chapter 1</p> <p>Page 1.24</p>

E. Parking Lot Layout

1. General Principles

Factors such as site topography, location of access roads, land availability, adjacent land use, and community requirements will determine in large part the layout of parking facilities. However, other factors to consider in the initial planning for parking lots are:

- a. Where possible, parking layout should be designed to maximize use of the accessible route to the platform. At low platforms, this is typically toward the outbound end, where the access platform is located.
- b. Avoid dead end aisles unless a turnaround is provided.

Where turnarounds are not possible in dead-end aisles, provide one striped space and sign it as a "turning-space-only" to eliminate the need to back out the length of the parking lot.

Provide for snow removal at the end of dead end aisles.

2. Parking Layout

a. Bay Orientation

Site conditions permitting, parking bays should be laid out perpendicular to the track and platform to allow people to walk down the aisles to the platform.

(As a rule of thumb, if a site has a curb to curb dimension measured at right angles to the track which is greater than 200 feet, the parking bays should be perpendicular to the track and platform. However, there may be specific site conditions or circulation requirements which dictate an orientation parallel to the track and platform.)

b. Parking Stall Orientation

90 degree parking is preferred. Use diagonal parking only when 90 degree parking is not feasible. Diagonal parking should not be used in structures. Follow accepted standards for diagonal parking such as the Handbook of Landscape Architectural Construction, published by the Landscape Architecture Foundation.

c. Perimeter Parking

Use 90 degree parking around the entire perimeter of the site where possible to maximize the capacity of the lot.

 <p>Messachusetts Bay Transportation Authority</p>	<p>RAILROAD OPERATIONS</p>	<p>Commuter Rail Design Standards Manual</p>	Stations and Parking	Section II
			<p>Circulation and Parking</p>	Chapter 1
<p>Revision No. 1</p>	<p>Date: 4/19/96</p>			<p>Page 1.25</p>

3. Dimensional Guidelines

a. General Notes:

Deviations from the dimensional guidelines shown in the accompanying diagram may be permitted in site-specific situations, however it is the responsibility of the design consultant to bring such deviations to the attention of the Authority for review and approval.

90 degree parking spaces may be shortened by up to 2'-0" where vehicles can overhang the curb. Vehicle overhangs must not interfere with the required clear width of an accessible pathway.

Avoid single row parking in parking structures.

b. Standards for 90 degree Parking for Use by the Physically Disabled

Provide minimum 8'-0" wide spaces with an adjacent 5'-0" wide striped access way. Depth, aisle, and bay dimensions should comply with those requirements for parking lots and structures of the Rules and Regulations of the AAB and the ADAAG.

Two spaces may share the same 5'-0" access way. Provide sidewalk ramps as necessary at the end of access ways to connect with the accessible route to the platform. Where accessible spaces are grouped together, it may be advantageous to lower the sidewalk to the level of the parking spaces. Accessible parking spaces and access aisles shall have surface slopes not exceeding 1:50 (2%) in all directions.

c. Standards for Parallel Parking on Surface Lots

Use parallel parking only where other layouts are impractical. Do not use parallel parking in any location where it might interfere with heavily traveled vehicular access routes.

Parallel parking spaces should be 8'0" wide by 22'0" long.

 <p>Messachusetts Bay Transportation Authority</p> <p>RAILROAD OPERATIONS</p>	<p>Commuter Rail Design Standards Manual</p>	<p>Stations and Parking</p>	<p>Section II</p>
		<p><b>Circulation and Parking</b></p>	<p>Chapter 1</p>
<p>Revision No. 1</p>	<p>Date: 4/19/96</p>	<p>Page 1.26</p>	

Standard Parking Stall Layout

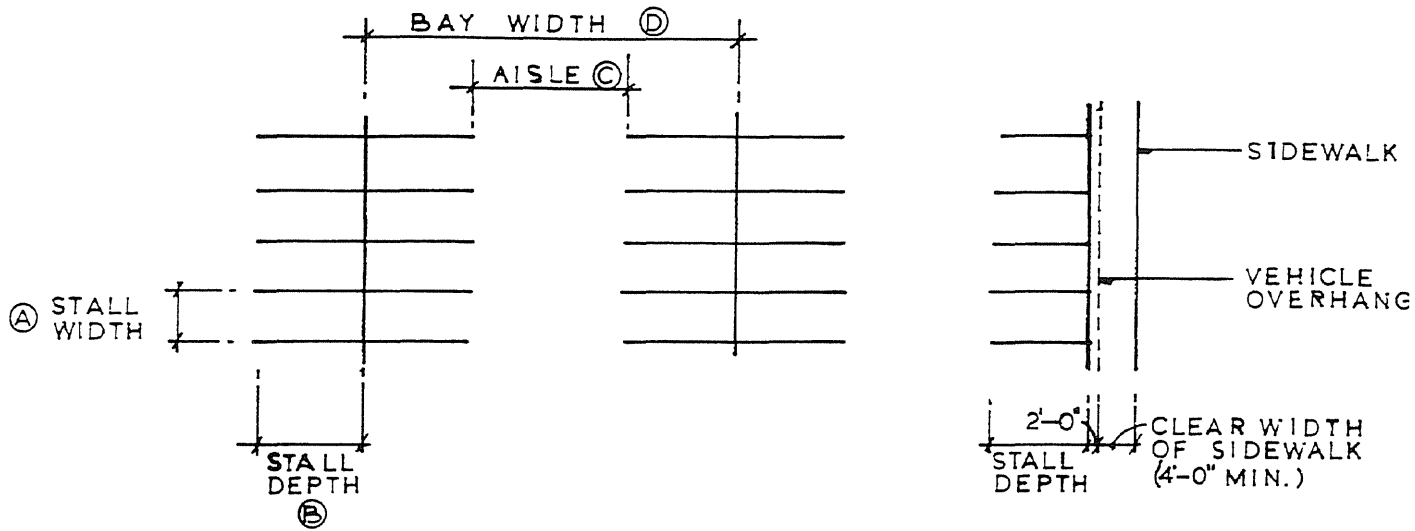

	TWO ROWS OF CARS			ONE ROW OF CARS			
	STANDARD		COMP.	STANDARD		COMP.	
	PREF.	ALT. BAY < 60 FT.		PREF.	ALT. BAY < 43 FT.		
<b>90° PARKING IN SURFACE LOTS</b>							
<b>A</b> STALL WIDTH	8'-3"	8'-6"	8'-0"	8'-3"	8'-6"	8'-0"	
<b>B</b> STALL DEPTH	17'-0"	17'-0"	15'-0"	17'-0"	17'-0"	15'-0"	
<b>C</b> AISLE	26'-0"	24'-0"	24'-0"	26'-0"	24'-0"	24'-0"	
<b>D</b> BAY WIDTH	60'-0"	58'-0"	54'-0"	43'-0"	41'-0"	39'-0"	
<b>90° PARKING IN PARKING STRUCTURE</b>							
<b>A</b> STALL WIDTH	8'-6"	N.A.	N.A.	8'-6"	N.A.	N.A.	
<b>B</b> STALL DEPTH	17'-0"	N.A.	N.A.	17'-0"	N.A.	N.A.	
<b>C</b> AISLE	26'-0"	N.A.	N.A.	26'-0"	N.A.	N.A.	
<b>D</b> BAY WIDTH	60'-0"	N.A.	N.A.	43'-0"	N.A.	N.A.	
COL. SPACING	58'-0"	N.A.	N.A.	41'-0"	N.A.	N.A.	

\* CONSULT HANDBOOKS FOR DIAGONAL PARKING LAYOUTS. (E. G.: ARCHITECTURAL GRAPHIC STANDARDS OR HANDBOOK OF LANDSCAPE ARCHITECTURAL CONSTRUCTION)

Accessible Spaces Without Curb

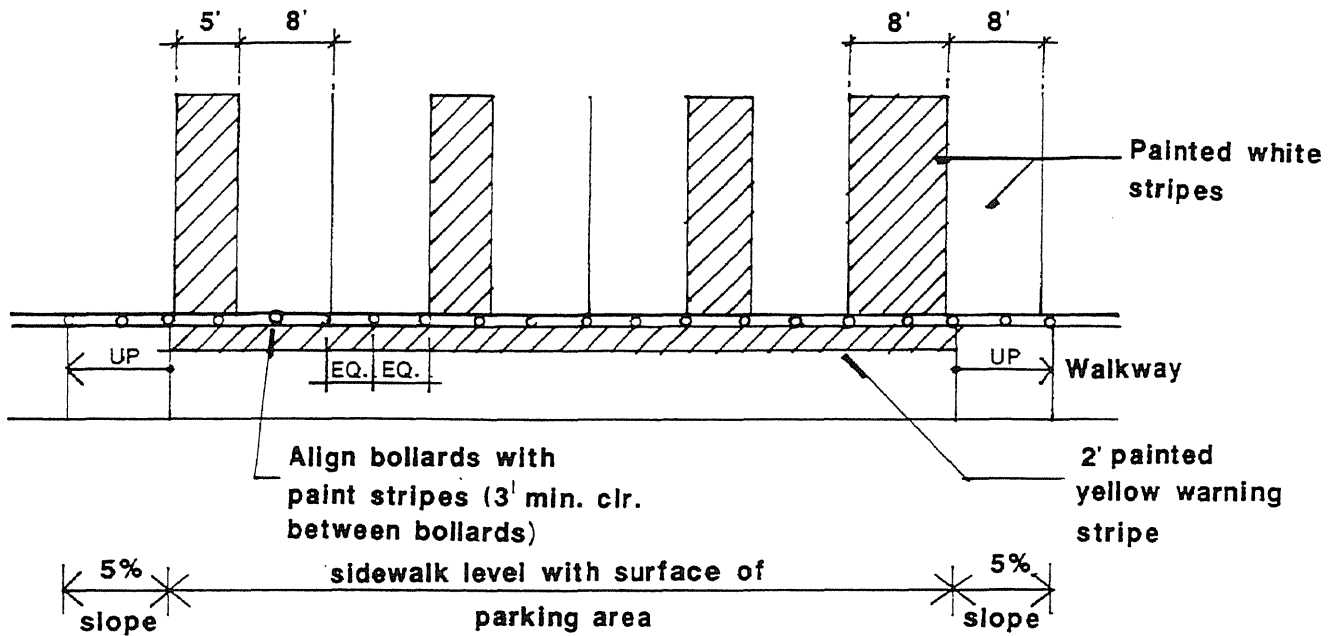

Access Through Parking Area

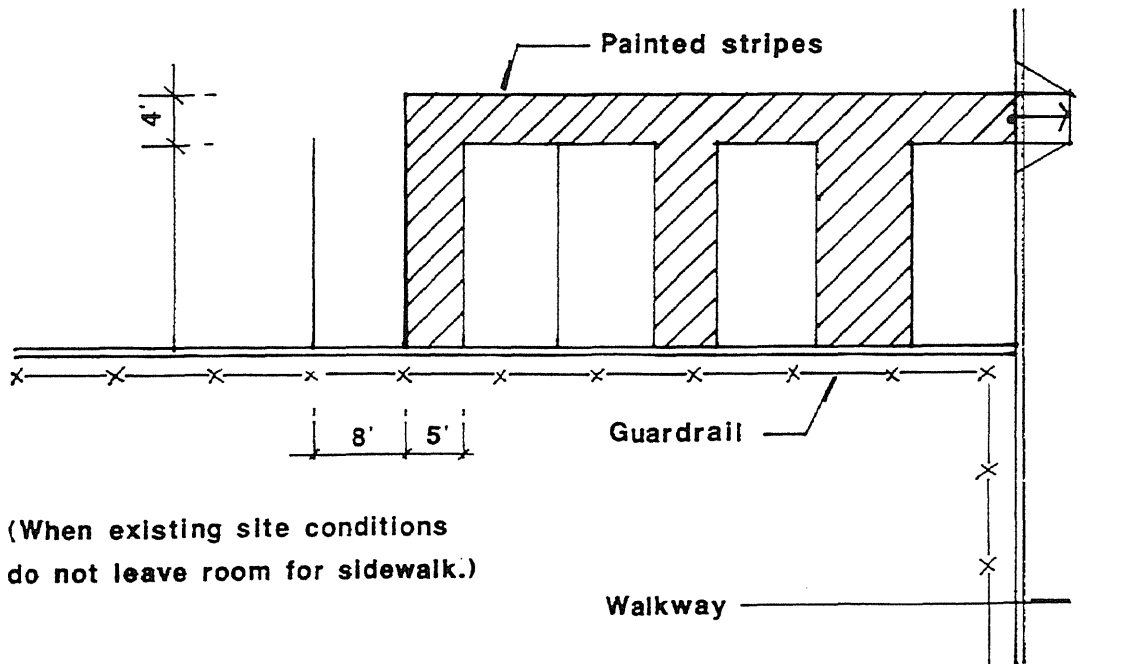

(When existing site conditions do not leave room for sidewalk.)

4. Accessible Parking

- a. The rules and regulations of the Architectural Access Board (AAB) of the Commonwealth of Massachusetts apply to the modernization or expansion of commuter rail parking facilities, including surface lots and garage structures. Federal regulations also require accessible parking be provided at these facilities.
- b. The MBTA Guide to Access addresses accessible parking at commuter rail stations. Accessible parking spaces must comply with Section 23 of the Rules and Regulations of the Architectural Access Board of the Commonwealth of Massachusetts and Section 4 of the Americans with Disabilities Act Accessibility Guidelines.
- c. Provide accessible parking spaces as follows:

<u>Total No. Parking Spaces</u>	<u>Required No. Accessible Parking Spaces</u>
1-25	1
26-50	2
51-75	3
76-100	4
101-150	5
151-200	6
201-300	7
301-400	8
401-500	9
501-1000	2% of total
1001 & over	20 + 1 for each 100 over 1,000

Note: One in every eight accessible spaces, but not less than one, shall be served by a minimum 96 in. access aisle and be designated "van accessible" as required by ADAAG 4.6.4.

Where there is more than one parking lot provided on the same side of the track, it is acceptable to place all accessible parking spaces in the parking lot closest to the platform. However, in such case, the total number of accessible spaces must be computed on a lot by lot basis and added together. They may not be computed from the total number of spaces in the lots. Provide signage at the auxiliary lots to indicate where the accessible parking spaces are located.

Where multiple lots are provided on both sides of the track, a proportionate number of accessible parking spaces must be placed on both sides of the track. If this is not possible, a variance must be obtained from the Massachusetts Architectural Access Board. Where there is more than one lot, the number of accessible parking spaces is calculated on a per lot basis.



5. Gradients

- a. The absolute maximum parking lot gradient is 5% (approx. 5/8" per foot). The absolute minimum acceptable gradient is 0.5% (approx. 1/16" per foot); the preferred minimum is 1% (approx. 1/8" per foot).

Where an accessible route occurs within the parking area, the maximum slope is 5% with a maximum cross slope of 2% except at aisles between accessible spaces.

- b. Crown the pavement in each parking bay at the center and pitch to the outside edges to avoid water ponding within aisles where pedestrians will walk.

6. Clearances

- a. To allow for vehicle overhang, the minimum clearance between the inside face of curbing in a parking lot and any object (such as signs, light poles, trees, fences and barrier walls) is 2'-0".
- b. Where parking is adjacent to track without a platform, provide vehicular guard rail mounted with chain link fence at a minimum of 8'-6" from the center line of track. Where vehicular guard rail is located less than 12'-6" from track centerline, provide a 15" clear space under the guard rail to facilitate cross tie replacement.

Typical Minimum Clearances, Low Platform

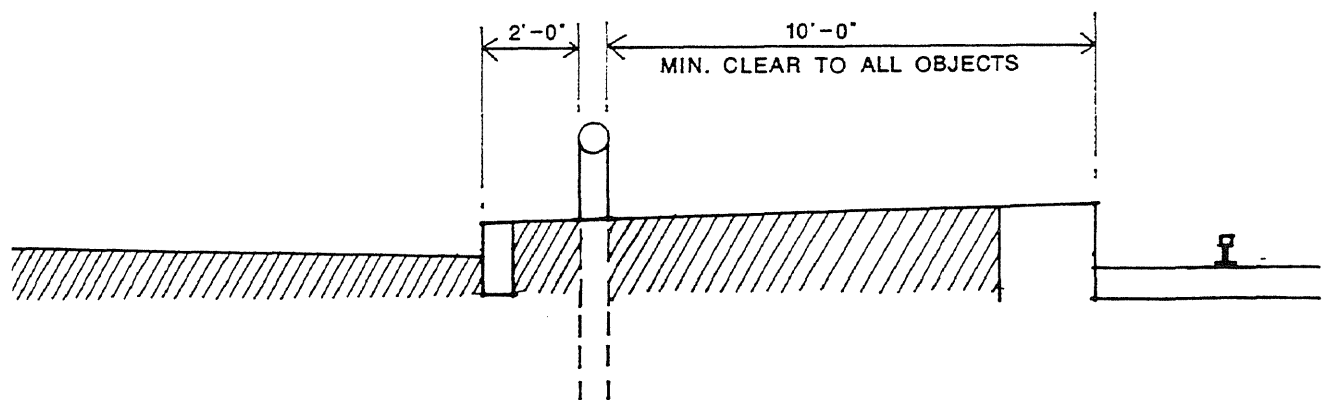

Minimum Clearance at Track, No Platform

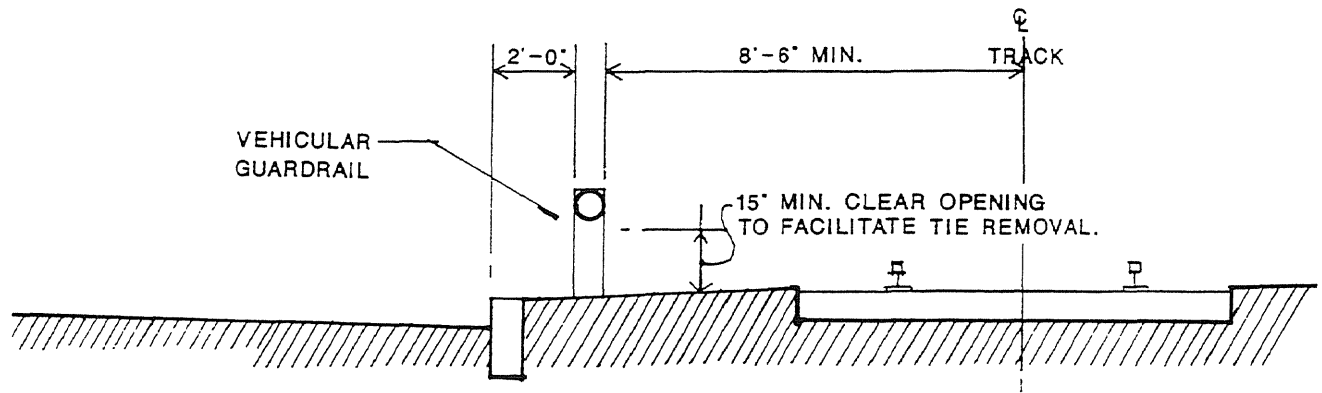

NOTE:  
WHERE RETAINING WALLS OCCUR ADJACENT TO TRACK, PROVIDE A MINIMUM CLEARANCE OF 12'-0" FROM CENTERLINE OF TRACK FOR REMOVAL OF TIES.

Typical Minimum Clearances (Platform More Than 8" Above Adjacent Surface)

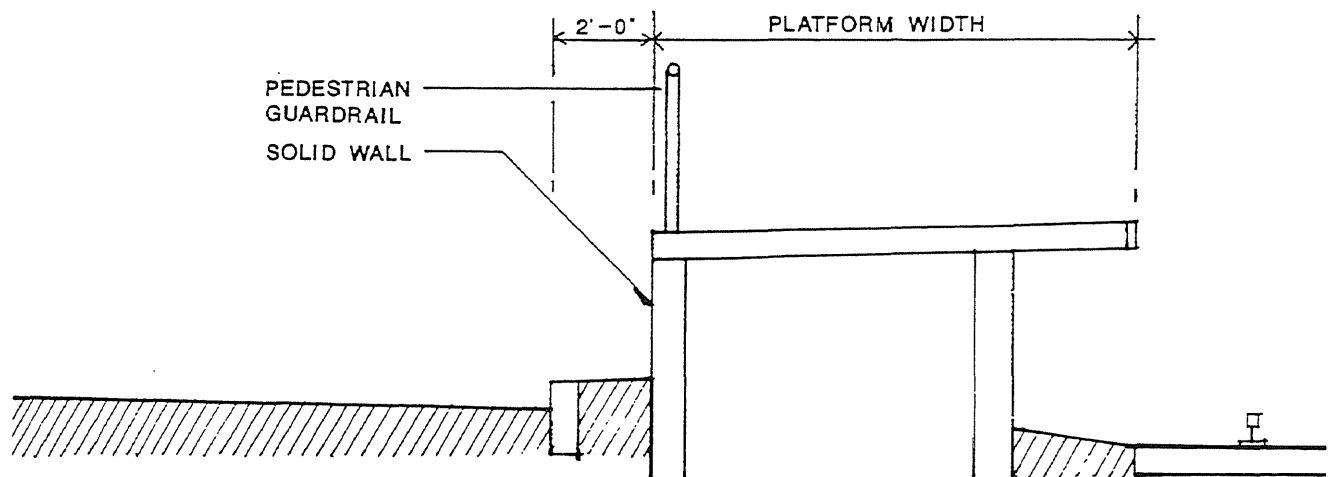

NOTE:  
FOR HIGH LEVEL PLATFORMS WITH SIDE PANELS WHICH ARE EASILY DAMAGED, PROVIDE A RAISED CURB 2'-0" AWAY FROM THE SIDE OF THE PLATFORM.

 <p>Massachusetts Bay Transportation Authority</p> <p>RAILROAD OPERATIONS</p> <p>Revision No. 1      Date: 4/19/96</p>	<p>Commuter Rail Design Standards Manual</p>	<p>Stations and Parking</p>	<p>Section II</p>
		<p>Circulation and Parking</p>	<p>Chapter 1</p> <p>Page 1.31</p>

**7. Pedestrian and Traffic Islands**

- a. Avoid islands since they make snow removal more difficult, increase cost, and complicate drainage. Provide painted islands at the end of bays; raised islands impede snow removal.
- b. General Guidelines (if needed)
  - (1) Islands should be a minimum of 4'-0" wide.
  - (2) Use long islands perpendicular to parking stalls only when necessary for grading or circulation. Provide 8' to 10' wide breaks at every other parking bay (approx. 120' intervals) to allow for plowing and pedestrian access.
  - (3) Avoid curbed inside corners since they make plowing difficult, trap debris and increase the number of drainage structures needed.

**F. Use of Landscape Buffers**

- 1. See Chapter 6 for specific design criteria governing the appropriate use of landscape buffers. In general, the Authority prefers to minimize unnecessary landscaping at commuter rail stations.
- 2. Where appropriate, lay out parking lots to preserve significant natural features--specimen trees, natural berms, outcroppings, etc--which may enhance the visual characteristics of the site. Such features should not detract from the operation, security, and capacity of the lot.
- 3. Lay out parking areas to leave sufficient space at the perimeter of the site to provide a buffer from surrounding neighborhoods or other sensitive receptors.

**G. Use of Barriers**

- 1. Use barriers in station parking areas to channel vehicular and pedestrian traffic, contain water run-off, and, in certain instances, limit pedestrian access to the site. Barriers should be used to maintain a safe separation between platform and vehicular circulation and parking. Typical barriers include curbing, guard rail, bollards, and fencing. (Conditions which govern the use of barriers are described below.)

**2. Types of Barriers:**

- a. Curbing

Curbing is the preferred method of defining the limits of a parking lot. Use curbing to control water run-off, to separate

 Massachusetts Bay Transportation Authority <b>RAILROAD OPERATIONS</b>	<b>Commuter Rail Design Standards Manual</b>	Stations and Parking <span style="float: right;">Section II</span>
		<b>Circulation and Parking</b> <span style="float: right;">Chapter 1</span> <span style="float: right;">Page 1.32</span>
Revision No. 1	Date: 4/19/96	

pedestrian and vehicular traffic, and to confine vehicle movements.

Granite is preferred as a curb material (7" maximum vertical reveal). Consider sloped granite as an alternative to vertical granite, but do not use sloped granite in areas of pedestrian circulation. Existing on-site granite curbing may be reused where possible.

If the lot can be easily drained to nearby ditches curbing may not be desirable. Guard rail or bollards should be used to confine vehicles to the paved lot where no curbing is provided.

Do not use the railroad right of way ditch for drainage of the parking area.

**b. Vehicular Guard Rail**

Vehicular guard rail is used to confine vehicle parking to specific areas. Under certain conditions, it is advisable to provide both curbing and guard rail (or bollards) as a secondary safety barrier (e.g. at the edge of an embankment).

**c. Bollards**

Use bollards for the same purposes as guard rail. However, bollards allow the free flow of pedestrians between them. Bollards interfere with snow plowing operations requiring either hand shoveling or the use of small machines. Therefore, their use should be minimized to short segments only where necessary.

**d. Pipe Rail**

Pipe rail may be used for pedestrian guardrails and as a means of channeling pedestrian movements. Typical applications occur along the back face of platforms with vertical drops in excess of 8", along the top side of retaining walls, and at stairs and ramps. Consult the pedestrian guardrail section of this chapter for design criteria.

**e. Fencing**

Use fencing to limit pedestrian access to the site for safety and security reasons. Fences adjacent to roadways and/or parking lots should be set back and protected by curbing or vehicular guardrail to allow for vehicle overhangs and the storage of plowed snow. Provide curbing or vehicular guardrail.

 Massachusetts Bay Transportation Authority <b>RAILROAD OPERATIONS</b>	<b>Commuter Rail Design Standards Manual</b>	Stations and Parking      Section II
		<b>Circulation and Parking</b> Chapter 1 Page 1.33
Revision No. 1	Date: 4/19/96	

f. Inter-track Fencing

Inter-track fencing is chain link fence installed between tracks to prevent pedestrians from crossing the tracks except at designated locations.

Inter-track fencing should 4'-0" high and extend a minimum distance of 200'-0" beyond the ends of the platforms. Consult Standard Plan No. 3204 for design criteria.

**H. Parking Area Drainage Requirements**

1. Authority policy is to install a storm drainage system in all new parking lots as well as those being upgraded.

Only small parking lots (generally those with under a twenty-five vehicle capacity) surrounded by porous soil capable of absorbing water run-off from the parking area may be designed without a storm drainage system. Do not drain toward the track right of way under any circumstances.

2. Storm drainage systems should conform with the Massachusetts Department of Public Works standards. See the Landscaping subsection for a description of drainage system design guidelines.

**I. Parking Fee Collection**

1. At stations where a parking fee is to be collected, the Authority uses a central coin-slot system to collect parking fees.

- a. The central coin-slot system consists of a centralized parking fee depository with numbered coin slots which are keyed to numbered spaces in the parking lot. The user deposits the fee as he or she walks to the platform. (See diagram following)

Location of the central collection box shall be determined by the Authority. Where possible, the central collection box should be highly visible and should be located under a canopy and on the same side of the track as the parking in a central area adjacent to the inbound platform. In larger parking lots, divide the lot into numbering zones of not more than 200 spaces. (See diagram following)

See MBTA Guide to Access for guidelines on how to make collection boxes accessible to the physically disabled. Collection boxes must be located on an accessible route.

- b. Parking spaces should be clearly marked and numbered consecutively.

 Massachusetts Bay Transportation Authority <b>RAILROAD OPERATIONS</b>	Commuter Rail Design Standards Manual	Stations and Parking <span style="float: right;">Section II</span>
		<b>Circulation and Parking</b> <span style="float: right;">Chapter 1</span> <span style="float: right;">Page 1.34</span>
Revision No. 1	Date: 4/19/96	

Parking Space Numbering For Fee Collection

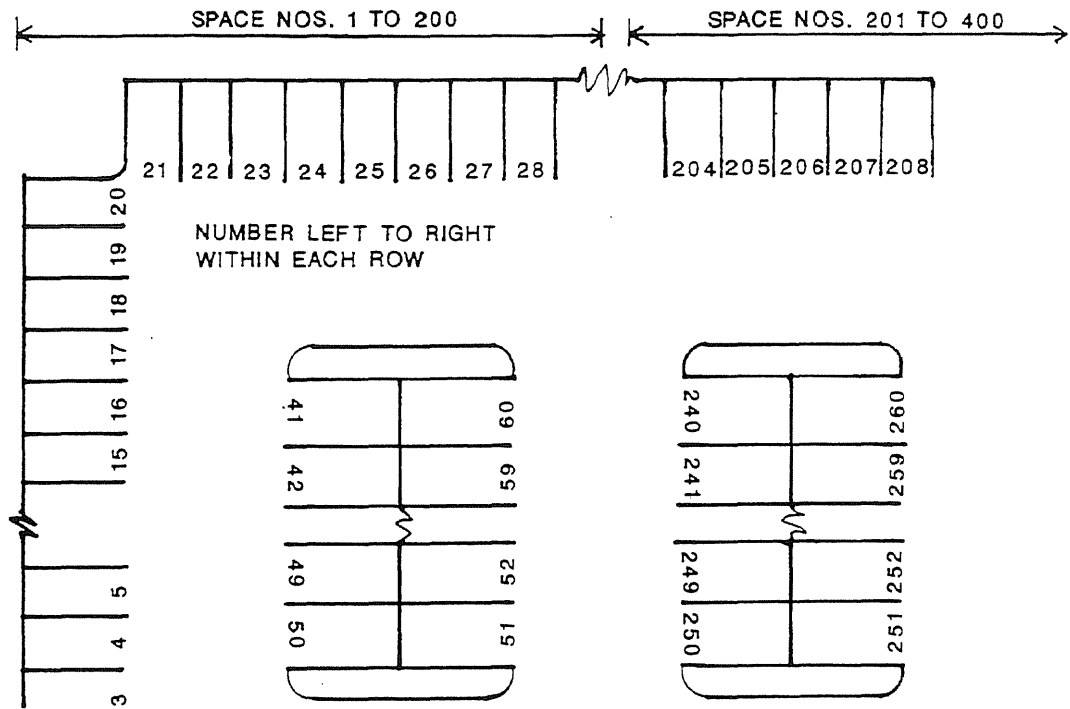

Example of Space Numbering

See Updated standard  
This section next sheet

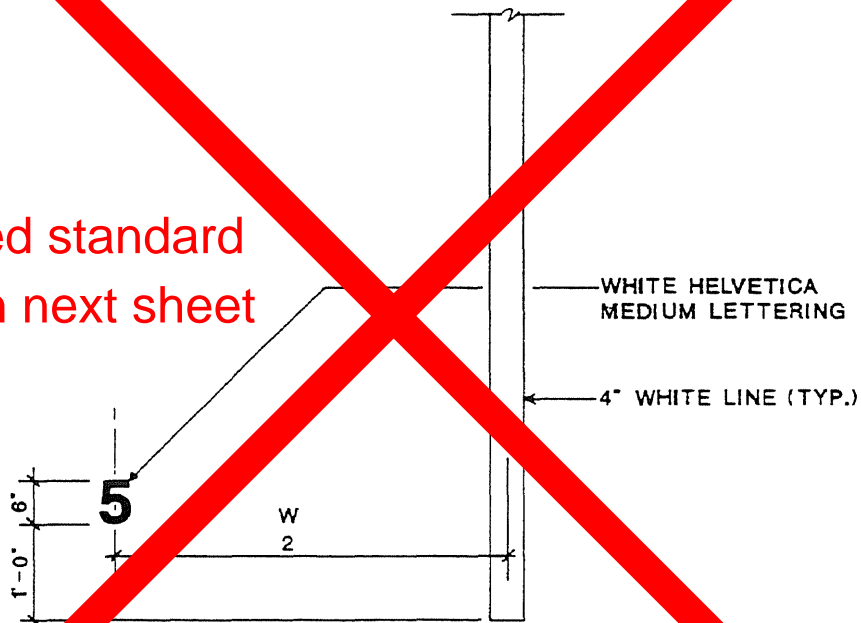

Group A  
Signage File  
COPY

Updated 9/21/01

MBTA Standard

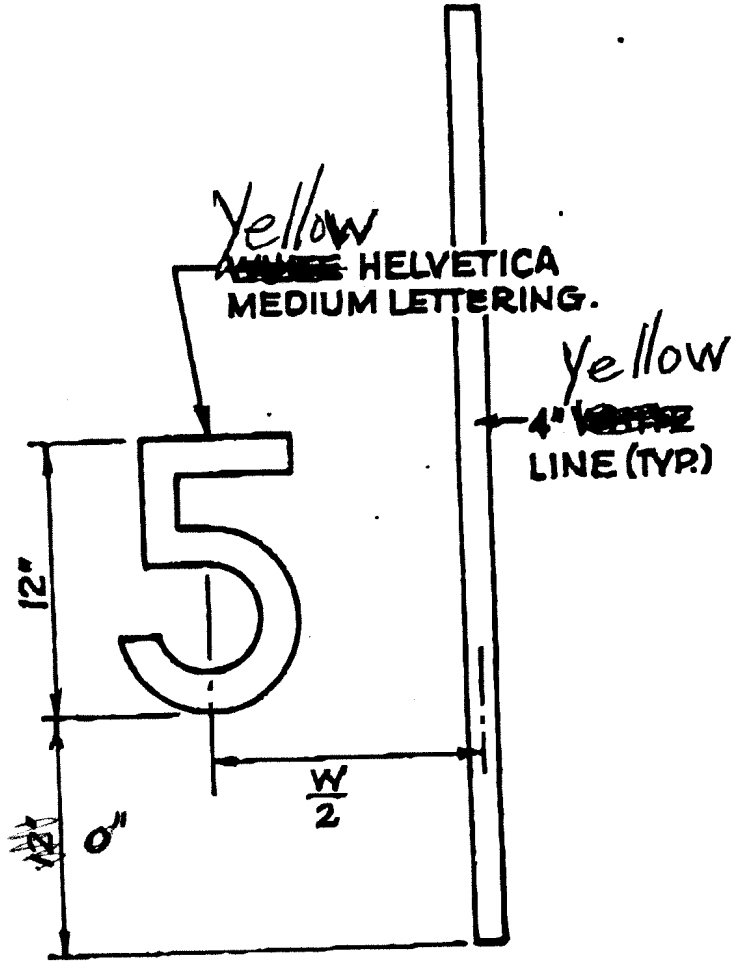

TYPICAL SPACE NUMBER

Elevation of Cash Box Panel

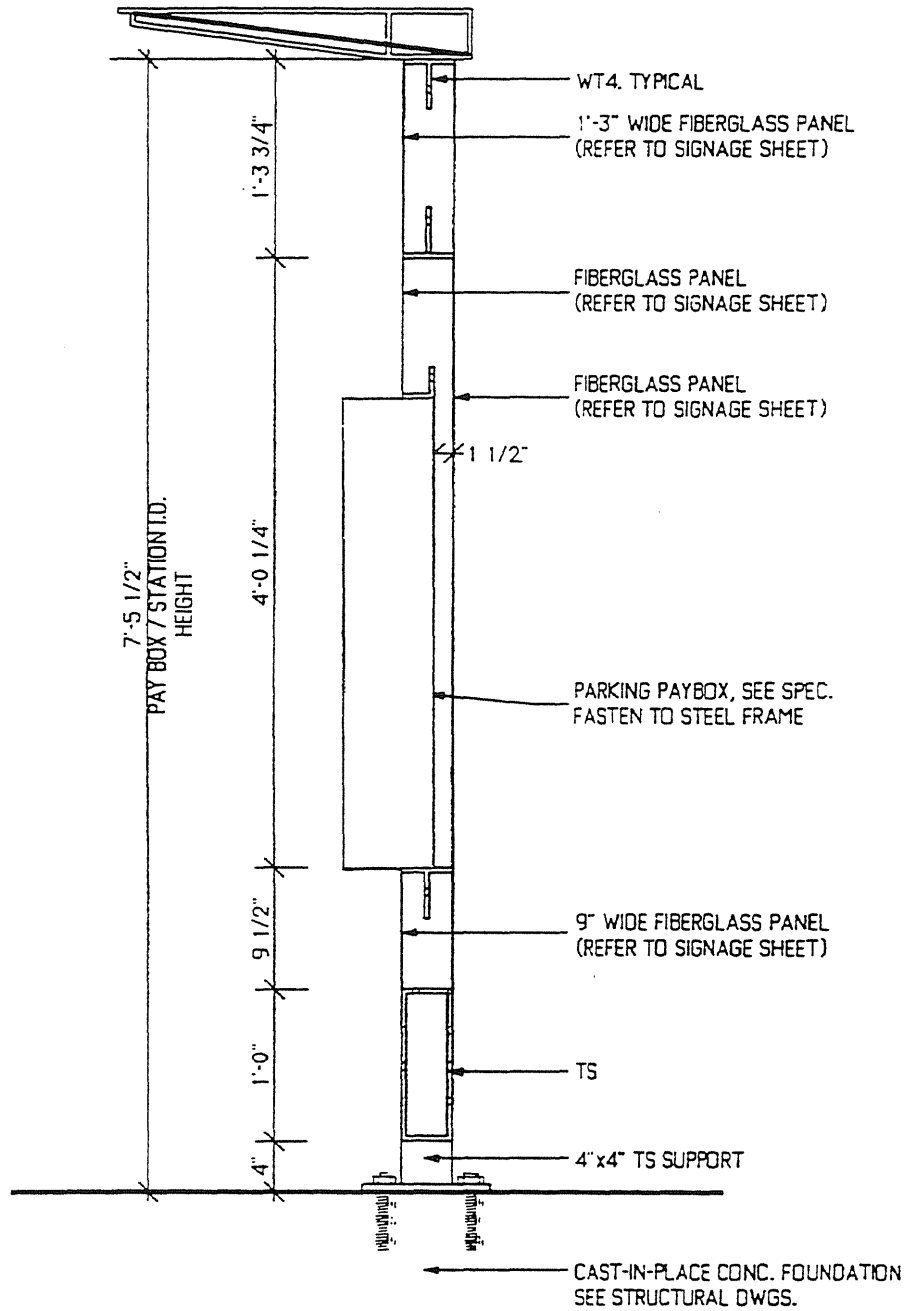

 <p>Massachusetts Bay Transportation Authority</p> <p>RAILROAD OPERATIONS</p>	<p>Commuter Rail Design Standards Manual</p>	<p>Stations and Parking</p>	<p>Section II</p>
		<p><b>Circulation and Parking</b></p>	<p>Chapter 1</p>
<p>Revision No. 1</p>	<p>Date: 4/19/96</p>	<p>Page 1.36</p>	



**IV. REFERENCE STANDARDS**

Consult the following reference standards for more information:

- o Architectural Graphic Standards, by Ramsey and Sleeper, Edited by the American Institute of Architects, Published by John Wiley and Sons.
- o Handbook of Landscape Architectural Construction
- o Mass D.P.W. Standard Specifications for Highways and Bridges (1988 Ed.)
- o MBTA Guide to Access
- o MBTA Standard Specifications
- o A Policy on the Geometric Design of Highways and Streets, Published by the American Association of State Highway and Transportation Officials.

**V. PREFERRED MATERIALS**

**A. Paving Materials**

<u>Material</u>	<u>Comments</u>
Bituminous	The Authority prefers to use bituminous Concrete to pave parking lots because it is durable, inexpensive, and easily repaired. See details Mass DPW Standard Specifications for Highways and Bridges.

**B. Curbing Materials**

<u>Material</u>	<u>Comments</u>
Granite	The Authority prefers to use granite curbing in parking lots because it resists damage from salt and snowplows.
Bit. Conc. Swales	Used to channel runoff to a catch basin when a more substantial curb is not required; formed integrally with paving. Often used in combination with guard rail.

**C. Barriers**

<u>Material</u>	<u>Comments</u>
Vehicular Guard Rail	Used to confine vehicular traffic to designated areas. May be either galvanized steel highway guardrail or heavy duty steel

pipe rail. See Mass DPW Standard Specifications for Highways and Bridges.

**Bollards**

Used to confine vehicular traffic while allowing pedestrians to pass through. Use concrete-filled galvanized steel pipe. Height varies:

- 2'-0" when used with a curb
- 2'-6" when used to define the edge of a parking area
- 4'-0" when used as a barrier (e.g. to close off a road)

**Fencing**

Used to limit access to a restricted area for security reasons, or to channel pedestrian traffic. Typically galvanized steel wire mesh. MBTA Standard Specifications.

**Pipe Rail/Guardrail**

Used to channel pedestrian flows and to minimize the possibility of an accidental fall from an elevated walking surface. Consult section on pedestrian guardrail for design criteria.

**D. Striping Materials**

Material

Comments

Roadway Marking Paint

Use roadway marking paint within the station to delineate traffic lanes, parking spaces, parking space numbers, crosswalks, etc. See Mass DPW Standard Specifications for Highways and Bridges.

---

**CHAPTER 2**  
**CANOPIES AND PLATFORMS**

## **I. INTRODUCTION**

This section establishes design objectives, guidelines, and design criteria for the construction of new shelters and platforms at commuter rail stations. Both high and low level platforms are discussed.

The objectives and guidelines presented below are a response to user needs and to the practical operating and maintenance requirements of the Authority. Surveys have indicated that shelter is the most important feature of a station to the commuter rail user.

## **II. DESIGN OBJECTIVES**

Comfort, safety, efficiency, and durability are the principal objectives to be considered in the design of platforms and shelters at commuter rail stations. The station shelters function primarily as a protection from the elements. However, they should be designed to include good lighting, visibility from both the inside and out, as well as multiple means of egress to enhance the users sense of safety. These objectives should also address specific issues of maintenance and snow removal.

## **III. DESIGN GUIDELINES**

### **A. PLATFORMS**

#### **1. LOCATION**

- a. All commuter rail stations should have a paved platform(s).
- b. A major consideration in determining platform location is achieving maximum visibility of the platform from the surrounding area for security reasons. Access should be as direct as possible from the surrounding area and parking lot.
- c. Platforms should be located to avoid conditions where a stopped train or a grade crossing gate will back-up local traffic on the crossing street (see illustration). The preferred platform arrangement at stations adjacent to grade crossings is a split configuration in which trains pull beyond the grade crossing far enough to clear the crossing signal circuit. Where this arrangement is not feasible, the preferred alternative is a configuration locating both platforms on the outbound side of the crossing. This arrangement clears the crossing during the evening period when traffic is typically heaviest.
- d. Locate platforms so that trains held at interlocking signals can load/unload.
- e. An important consideration in the location of platforms is the topography and access for maintenance and snow removal equipment.

 Massachusetts Bay Transportation Authority  <b>RAILROAD OPERATIONS</b>	<b>Commuter          Rail          Design          Standards          Manual</b>	Stations and Parking	Section II
		<b>Canopies and Platforms</b>	Chapter 2
Revision No. 1	Date: 4/19/96		Page 2.1

It is not desirable to locate platforms where the right-of-way topography is severe, since this will require the construction of retaining walls that will increase the cost per linear foot of the platform.

2. SAFETY

- a. Platforms should have adequate space for passengers gathering on the platform and waiting in line to board the train during peak times.
- b. Platform areas should be well lighted and drained and should have a slip-resistant surface.
- c. The track side edge of the platform must have a tactile warning strip.
- d. Minimize the number of obstructions on the platform to insure maximum visibility of the platform by the train crew, as well as to insure good pedestrian flow and access of maintenance vehicles.

3. EFFICIENCY

- a. Access to platforms should be highly visible and direct from drop-off/pick-up points and pedestrian walkways.
- b. Platforms should be free of columns, utility poles, and other objects impeding free pedestrian flow.

Platform Location Diagram

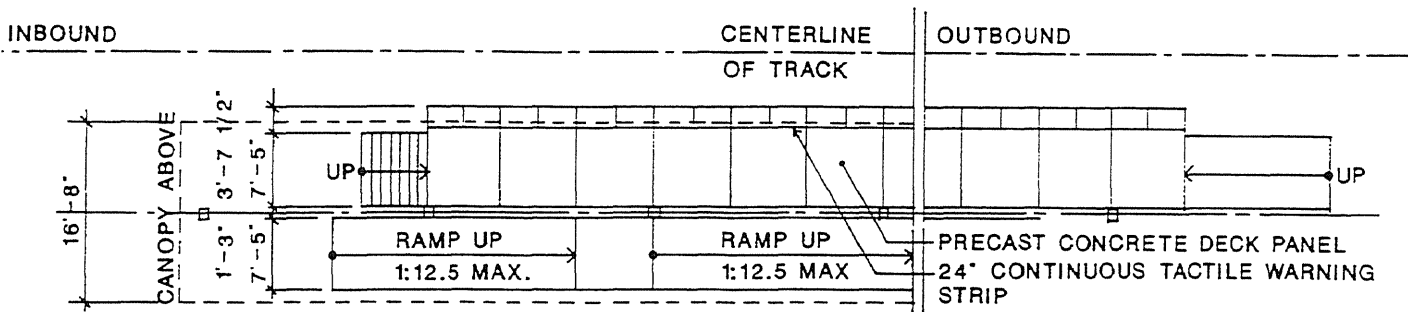

**Note:** Coordination of track alignment and profile with the precast concrete station platform is critical! Track alignment and profile must be surveyed and verified by Massachusetts licensed surveyor.

Preferred Arrangement of Platforms at Grade Crossing

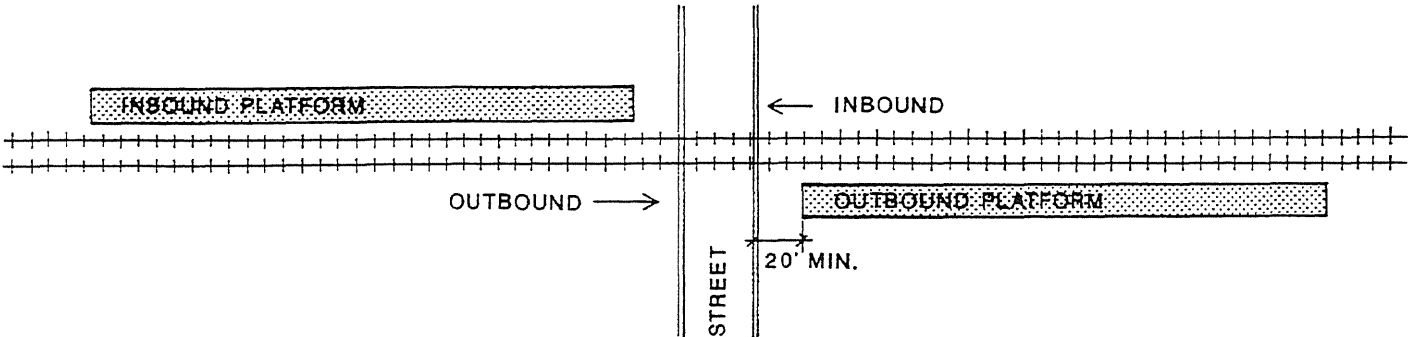

Alternative Arrangement of Platforms at Grade Crossing

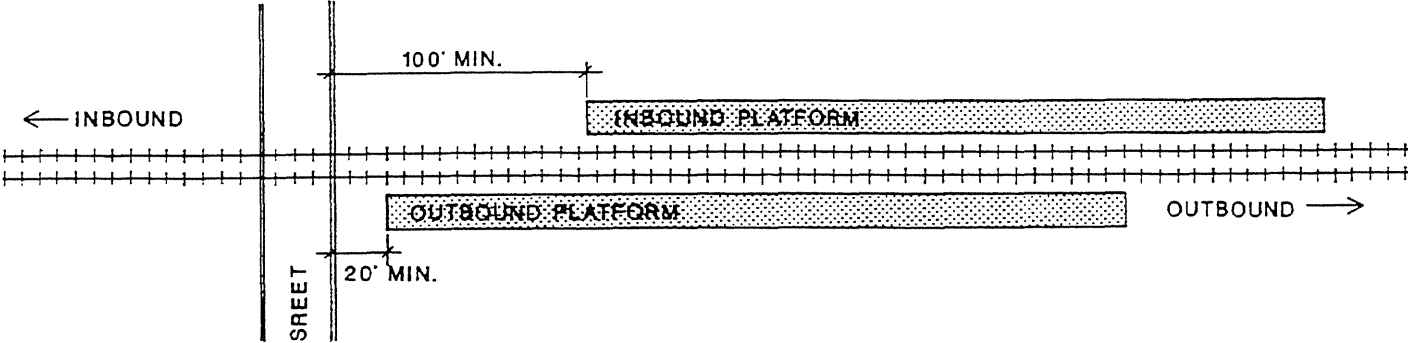

4. USE OF BARRIERS

- a. Provide barriers along the back face of a platform under the following conditions:
  - o Where there is a sharp drop in elevation exceeding 2'-0".
  - o Where active freight tracks are located behind the platform. Random pedestrian crossing of these tracks is a potential safety hazard that can be minimized through the use of a barrier that channels pedestrian movements to specific points.
  - o Where a parking lot abuts the platform. Under this condition the barrier serves as a primary or secondary deterrent to vehicle access to the platform. When a barrier system such as a guard rail is used in this situation it may also double as a sitting area for waiting passengers, as the accompanying detail illustrates.
- b. Typical barrier systems that might be used along the back face of a platform include pipe rail, guard rail, and wire mesh fencing. The choice of system will depend on factors such as the magnitude of the safety problem (i.e. protecting a person from a ten foot fall or it may simply be a reminder to cross tracks at a specified location) and specific project funding limitations.

Detail of Barrier System Limiting Vehicle Access to Platform Area

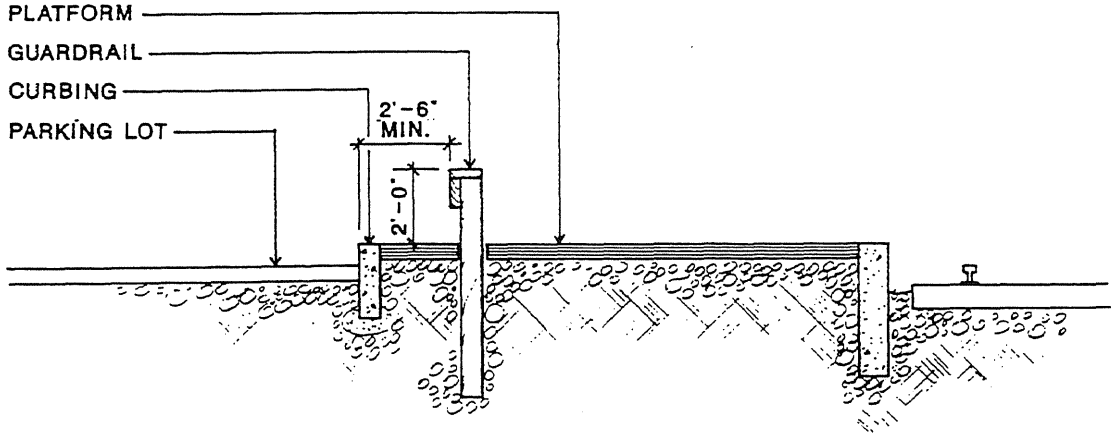

**B. SHELTERS**

1. GENERAL

- a. Canopy structures should provide overhead and wind protection along portions of the platform(s). When combined with a vertical windscreen panel, the canopy provides the user a moderate amount of protection from rain, snow, and wind. At the same time, it is a relatively economical and low-maintenance form of shelter.
- b. It is not economically feasible to provide heat in this type of open-air shelter.

2. LOCATION

- a. New shelters should be located on or adjacent to the platform in areas that are the most visible from adjacent streets and neighborhoods. For low level platforms, canopies must be provided for the protection of access platforms and ramps. Generally a second canopy should be provided at a central location on the low platform. High level platforms may only require a single shelter, however the location(s) must provide for the protection of any access ramp(s) serving the platform(s).
- b. New shelters should also be located on the most directly accessible route from the site entrance(s) to the platform when this location does not conflict with the high visibility guidelines described above.
- c. New shelters should be designed and located in a manner that does not obstruct the visibility of the conductors in the approaching trains.

3. CONVENIENCES

A detailed description of the types of conveniences that should be provided appears in the Comforts and Conveniences chapter.

4. LIGHTING

Lighting design guidelines for buildings and canopies are presented in the Lighting chapter of this manual.

**C. ACCESSIBILITY FOR SHELTERS AND PLATFORMS**

- 1. All shelters and platforms should be readily accessible via primary site entrance/exit.
- 2. Persons with disabilities must have full access to all shelters and platforms, as specified in the Rules and Regulations of the

 Massachusetts Bay Transportation Authority <b>RAILROAD OPERATIONS</b>	<b>Commuter Rail Design Standards Manual</b>	Stations and Parking <span style="float: right;">Section II</span>
		<b>Canopies and Platforms</b> <span style="float: right;">Chapter 2</span>
Revision No. 1	Date: 4/19/96	Page 2.5



Massachusetts Architectural Access Board, Americans with Disabilities Act Access Guidelines, and the MBTA Guide to Access. For 'key' station sites, refer to ADAAG Section 6, the MBTA Guide to Access and consult with the Authority for specific requirements. Some of the requirements pertaining to shelters are summarized below.

- a. The approach to the primary entrance/exit of all shelters shall be uninterrupted by steps. If there is a change of elevation, a ramp will be provided in conformance with the ramp design requirements described in the Circulation subsection of this manual.
- b. Access should be as direct as possible from the surrounding area and parking lot to platform.
- c. New stations shall have full length high level platforms.

**IV. DIMENSIONAL GUIDELINES**

**A. PLATFORMS**

**1. ELEVATION**

- a. The standard height of low level platforms is 8" above top of rail on non-super-elevated tracks; the horizontal clearance between the centerline of track and the track-side face of a low-level platform curb shall be 5'-1" on tangent track. Mini-high level platforms are required on the outbound end of low level platforms.
- b. The standard height of high level platforms is 4'-0" above top of rail on non-super-elevated tracks; the horizontal clearance between the centerline of track and the track side of a high level platform shall be 5'-7" on tangent track. This horizontal dimension applies only to locations where freight clearance is not a problem.
- c. Mini-High level platforms requiring additional freight clearance shall be equipped with a "flip-up" platform edge (Consult the Authority for details of this special edge detail).

**2. LENGTH**

- a. Unless otherwise directed, platforms must accommodate a 9 car train. On low platforms, the access platform (mini-high) is included in the length of the platform.
- b. The length of outbound platforms should be equal to the length of the longest train serving the station plus a 20'-0" allowance for a train overshooting or undershooting the platform. The intention is to provide disembarking passengers the opportunity

 <p>Massachusetts Bay Transportation Authority</p>	<p><b>RAILROAD OPERATIONS</b></p>	<p>Commuter Rail Design Standards Manual</p>	<p>Stations and Parking</p>	<p>Section II</p>
	<p>Revision No. 1</p>		<p>Date: 4/19/96</p>	<p><b>Canopies and Platforms</b></p>
			<p>Page 2.6</p>	

to exit the train directly from any coach. Typically, trains are 2 to 12 coaches in length. The following formula can be used to calculate outbound platform length:

- o Number of coaches on longest train x 85'-0" + 20'-0" = length of platform. (In general, design for 9 cars unless directed otherwise).
- c. The length of the inbound platform may be shorter than the longest train. It is standard MBTA practice to run the locomotive always on the "country" or outbound end of the train set. As a result, the engineer on an inbound train in the control cab of the front car of the train set is always blocking passenger access to the front door of the first car. However, the rear door of the first car remains accessible. The inbound platform may therefore be 55'- 0" shorter than the length calculated by the above formula for the outbound platform.
- d. The absolute minimum platform length is 2 coach modules + 20'-0" or 190'-0".

**3. WIDTH**

- a. Platforms should be sufficiently wide to comfortably accommodate peak loading requirements. The width is also affected by line, available space, and ridership only at short platforms. Adequate comfort levels for waiting and boarding movements can be achieved at a maximum density of 5 sq. ft. per person. As the following example illustrates, the maximum density level will rarely be approached at commuter rail stations.
  - o Assume a peak train boarding level of 200 people (about 1/3 system stations average this number or more). At a density of 7 sq. ft. per person, the space requirement is 1,400 sq. ft. Assume an absolute minimum length platform that is 190'-0" long and 10'-0" wide. The effective width of the platform (allowing for 2'-0" safety clearance at the track side face of the platform) will be 8'-0" and the effective area of the platform will be 1,520 sq. ft. or in excess of the 1400 sq. ft. minimum. With platforms generally in the range of 700-800 feet in length, standing/boarding capacity is normally of no concern.
- b. The preferred platform width is 12'-0"; 10'-0" is acceptable and 8'-0" is the absolute minimum width.
- c. For reasons of economy, long platforms may be tapered at the ends to a minimum width of 8'-0".
- d. The preferred island platform width is 22'-0" for a minimum of

1/2 the platform length. Ends of island platforms may taper to a minimum width of 12'-0".

**4. GRADIENT**

Platforms should comply with accessibility regulations which state that the cross slope (the slope perpendicular to the direction of the tracks) can be a maximum of 2%; or not exceeding 1 ft. of rise for every 50 ft. of run.

**5. WARNING STRIPE**

All platforms must have a 24" yellow tactile warning strip running the length of the platform to comply with ADA access guidelines. Tactile warning strip should not be installed at low level platform ends.

**B. SHELTERS**

**1. Size**

a. The sheltered area at each station should accommodate approximately sixty percent of the passengers boarding at times of peak volume. This figure reflects two considerations: first, that about twenty percent of the passengers either wait in their automobiles or arrive at the last minute and do not use the shelter. Secondly, economic considerations do not allow the Authority to fully accommodate peak period needs.

b. The optimal size of the platform canopy should be determined as follows:

- o Assume no shelter is currently at the station.
- o Number of passengers using peak volume train = 100.
- o Design capacity of shelter = 60 % of 100 = 60
- o Net area required = 60x7 sq. ft. = 420 sq. ft.
- o Gross area required = 420x1.05 = 447 sq. ft. or approximately 400-450 sq. ft. of shelter.

**2. MINIMUM CLEARANCES**

a. The preferred minimum horizontal clearance between vertical support for a canopy and the track-side edge of platform is 10'-0". The absolute minimum is 8'-0".

b. The minimum horizontal clearance between a canopy roof overhang and the centerline of any track is 7'-6" (8'- 6" on the Framingham/Worcester Line) except where the canopy is at a height that overhangs operating equipment. The minimum clearance from the track centerline to face of canopy columns, wall, or other obstruction is 15'-1".

 <p>Massachusetts Bay Transportation Authority</p> <p><b>RAILROAD OPERATIONS</b></p>	<p>Commuter Rail Design Standards Manual</p>	<p>Stations and Parking <span style="float: right;">Section II</span></p>
		<p><b>Canopies and Platforms</b> <span style="float: right;">Chapter 2</span></p> <p style="text-align: right;">Page 2.8</p>
<p>Revision No. 1</p>	<p>Date: 4/19/96</p>	

- c. The minimum clearance between the floor and the vertical panel in a canopy is 6". This clearance prevents the accumulation of leaves and debris in corners of the canopy.
- d. The vertical clearance from the top of rail to the bottom face of the canopy adjacent to track is 12'-1".
- e. Refer to MBTA Railroad Operations Book of Standard Plans, Roadway and Track for further clearance information, drawing No. 1013 in particular for station requirements.

Detail of Minimum Shelter Clearances

Note: Design consultant should verify with MBTA the current standard canopy/platform detail before proceeding with final design.

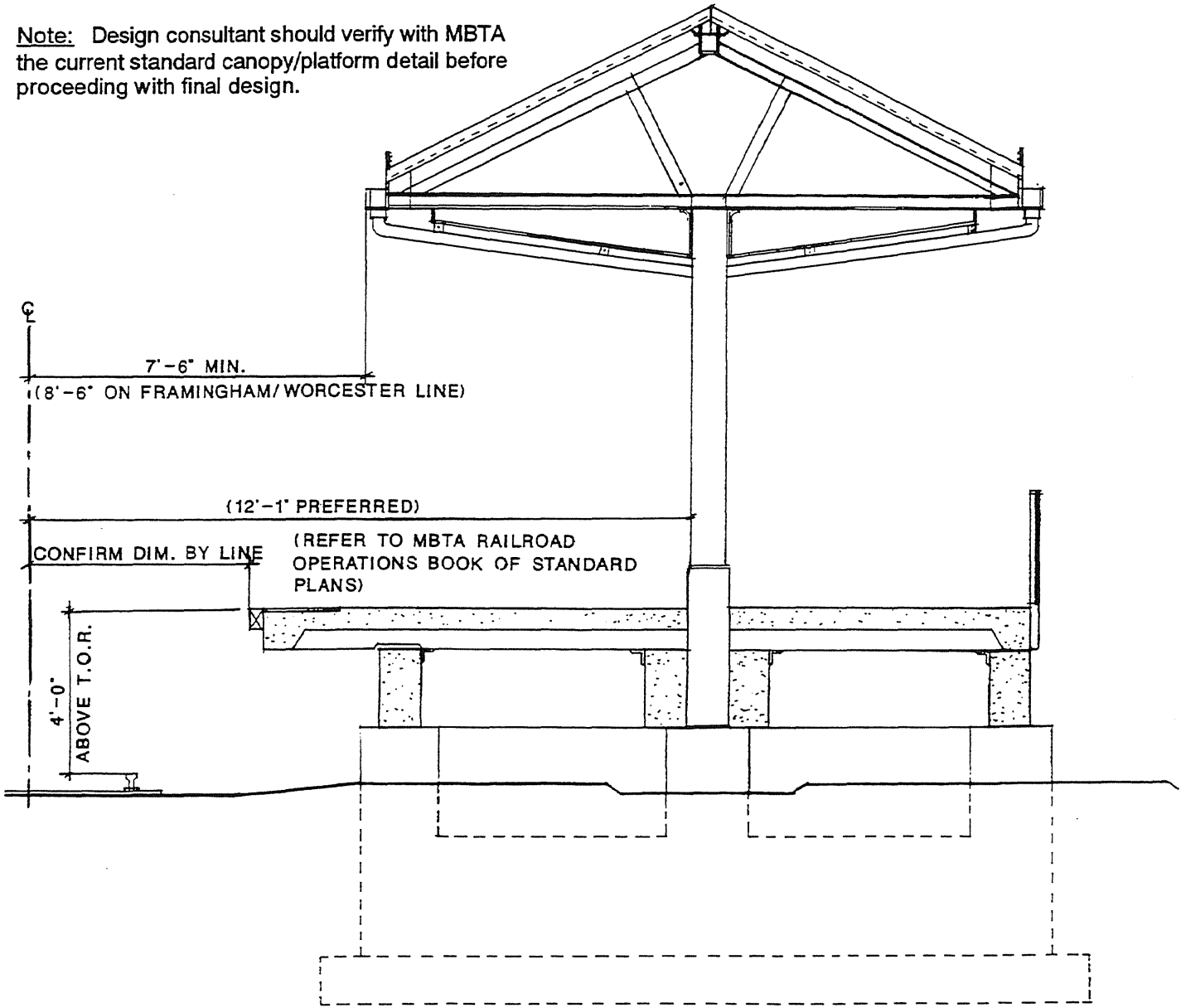

**V. DESIGN CRITERIA AND DETAILS**

**A. PLATFORM**

**1. PAVING MATERIALS**

High level platforms shall be architectural precast concrete. Please refer to structural drawings provided by the Authority for reinforcing, connections, and bearing. Low level platforms are constructed of bituminous concrete with timber or pre-cast concrete curbing. Design and construction of all work shall conform to the following:

- o MBTA Standard specifications including special provisions
- o Massachusetts Building Code, 5th edition
- o Americans with Disabilities Act Accessibility Guidelines (ADAAG)
- o Rules and Regulations of the Architectural Access Board (AAB) of the Commonwealth of Massachusetts

In case of conflict between the codes, standards, regulations, specifications, general notes and/or manufacturer's requirements use the most stringent provisions.

**2. PLATFORM CURBING WITH TACTILE WARNING**

Platform curbing is essential to the creation of a safe and durable transition between the train and the platform. All platforms must be curbed with a 24" tactile warning strip. See accompanying details for precast and timber curbing

**Precast Concrete Edge for Commuter Rail High Platforms**

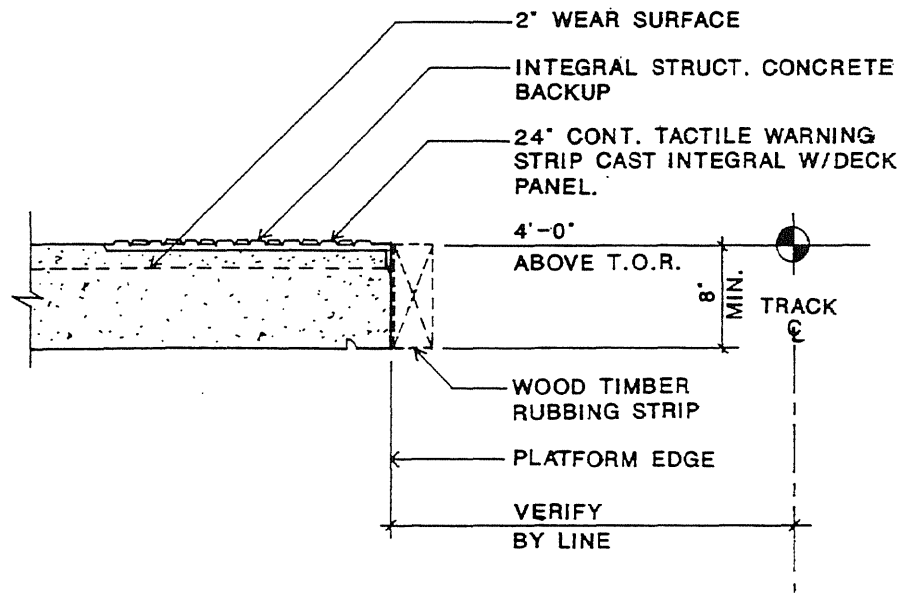

 <p>Massachusetts Bay Transportation Authority</p> <p><b>RAILROAD OPERATIONS</b></p> <p>Revision No. 1      Date: 4/19/96</p>	<p>Commuter Rail Design Standards Manual</p>	Stations and Parking	Section II
		<p><b>Canopies and Platforms</b> Chapter 2</p> <p>Page 2.10</p>	

Precast Concrete Edge Unit for Commuter Rail Low Platforms

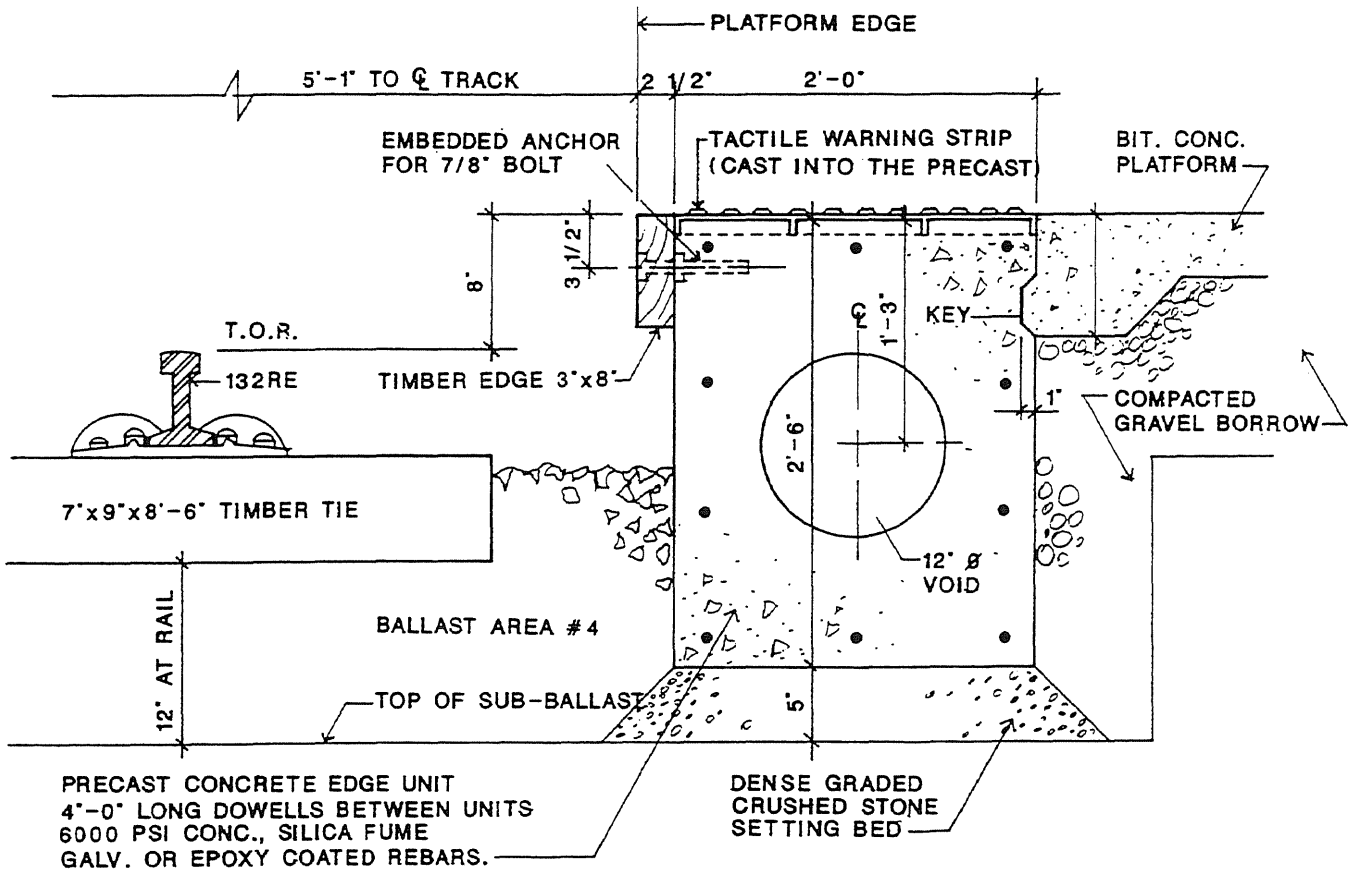

 <p>Massachusetts Bay Transportation Authority</p> <p><b>RAILROAD OPERATIONS</b></p> <p>Revision No. 1</p>	<p>Commuter Rail Design Standards Manual</p>	<p>Stations and Parking</p>	<p>Section II</p>
		<p><b>Canopies and Platforms</b></p>	
<p>Date: 4/19/96</p>			<p>Page 2.11</p>

3. BARRIERS

- a. Pipe Rail: should be used to channel pedestrian movements, not as a safety barrier. Typical details are presented in the Circulation chapter.
- b. Guard rail: should be either galvanized steel, heavy timber, or either type of rail used in conjunction with concrete posts. Steel guard rail should conform with the MDPW Standard Specifications for Highways and Bridges, Division III, Section M8. Heavy timber guard rail is typically less expensive than galvanized steel and should be of a type similar to that described in the Circulation chapter.
- c. Fencing: A wire mesh type of fencing may be used in certain platform locations. Standard Authority details for wire mesh fencing are shown in the Circulation chapter.

B. SHELTERS

The MBTA has established design standards that specify the appropriate materials and types of construction that must be used for shelters. This documentation may be obtained directly from the Authority.

 <p>Massachusetts Bay Transportation Authority</p> <p>RAILROAD OPERATIONS</p> <p>Revision No. 1      Date: 4/19/96</p>	<p>Commuter Rail Design Standards Manual</p>	Stations and Parking	Section II
		Canopies and Platforms	Chapter 2
		Page 2.12	

---

**CHAPTER 3  
LIGHTING**



**I. INTRODUCTION**

This section describes commuter rail station illumination requirements. Station area illumination is a critical factor in the enhancement of the rider's comfort and perception of safety. Therefore, careful consideration to both the quality and quantity of light is necessary.

**II. DESIGN OBJECTIVES**

Security, visual comfort, compatibility with surrounding uses, efficiency, and attractiveness should be addressed in the design of commuter rail station site lighting.

**A. SECURITY**

The primary function of lighting is to make the commuter rail station and site safe and secure, as well as visible from surrounding areas.

**B. EMPHASIS**

Highlighting should be used to emphasize potential hazards, informational signage, and major focal and access points which include:

- o Stairs
- o Ramps
- o Vehicular and pedestrian track crossings
- o Platforms
- o Pedestrian crosswalks
- o Tracks
- o Shelters
- o Drop-off/pick-up areas
- o Building entrances and exits
- o Vehicular entrances and exits
- o Signage

**C. VISUAL COMFORT**

To insure visual comfort, station and site lighting should:

- o Provide the appropriate level of lighting.
- o Provide the appropriate contrast between lighting levels.
- o Minimize glare. Light sources should not be located within the normal visual angle of pedestrians or drivers.
- o Minimize reflected glare from smooth surfaces, such as signs.

 Massachusetts Bay Transportation Authority <b>RAILROAD OPERATIONS</b>	<b>Commuter Rail Design Standards Manual</b>	Stations and Parking	Section II
		<b>Lighting</b>	Chapter 3
Revision No. 1	Date: 4/19/96	Page 3.1	

**D. COMPATIBILITY WITH SURROUNDING USES**

Station and site lighting should not interfere with:

- o Adjacent residential neighborhoods
- o Train operation and signals
- o Operation of vehicles off-site

**E. EFFICIENCY**

One consideration in the selection of lighting type should be its lifetime cost. This includes the cost of purchase, installation, operation, maintenance, and replacement of lamps and standards.

**F. ATTRACTIVENESS**

Commuter rail station and site lighting hardware should be:

- o Compatible in appearance with the surrounding environment.
- o Durable under the following conditions: extreme weather conditions, vandalism, dirt accumulation, and limited maintenance.

**III. DESIGN GUIDELINES**

**A. ILLUMINATION LEVELS**

The following illumination levels satisfy the objectives discussed above. However, the designer may deviate from the standards listed below to compensate for specific operating or site conditions.

LOCATION	AVERAGE MAINTAINED FOOTCANDLES
Parking Lots	1-2
Platforms	2-5
Canopies	5-10
Station Buildings	5-10
Shelters	10
Stairs	5-10
Underpasses, Enclosed Overpasses	5-10
Sidewalks and Overpasses	5
Handicap Access Ramps/Parking	5-10

**B. OPTICAL CONSIDERATIONS**

In the design of station building and site lighting, the contrast between various surfaces within eye contact should be maintained at ratios that will not reduce visual acuity, result in visual discomfort, or cause direct or reflected glare.

1. Contrast Ratios

The ideal contrast ratio between illuminated areas and adjacent or surrounding areas should be limited to 20:1. In no case should it exceed 80:1. The contrast between emphasis lighting and surrounding surfaces should not exceed a ratio of 3:1. The relative levels of luminance of signs and information panels to adjacent and background surfaces should not exceed a ratio of 5:1.

2. Glare

Luminaires should be designed and located to prevent the source's full brightness from being visible to the eye within normal viewing angle as shown in the accompanying illustration.

3. Reflected Glare

The angle of view of a vertical surface should exceed the angle at which light strikes the surface to avoid direct reflections from the source, as the accompanying diagram illustrates.

4. Methods of Control

Contrast ratios, glare, and reflected glare can be controlled through use of the following:

- o Diffusers to moderate source brightness whenever possible.
- o Indirect lighting, such as "wall washing" with light, to control glare and reduce the contrast ratio between a light source and the surrounding environment.
- o Parabolic reflectors within light fixtures to control a light source without sacrificing light intensity on the lighted surface. They are especially useful with High Intensity Discharge (HID) lighting near residential neighborhoods.
- o Contrast ratios and glare can also be controlled by adjusting the location and intensity of the source.

**C. EMPHASIS OF HAZARDOUS AND TRANSITION AREAS**

Higher levels of light should occur at potential danger or decision areas (stairs, track crossings, street crossings, platform edges, hidden corners, railings, and signage). This illumination should be at least 5-10 average maintained footcandles at the surface being lighted.

 Massachusetts Bay Transportation Authority <b>RAILROAD OPERATIONS</b>	<b>Commuter Rail Design Standards Manual</b>	Stations and Parking	Section II
		<b>Lighting</b>	Chapter 3
Revision No. 1	Date: 4/19/96	Page 3.3	

Example of Method Minimizing Direct Glare

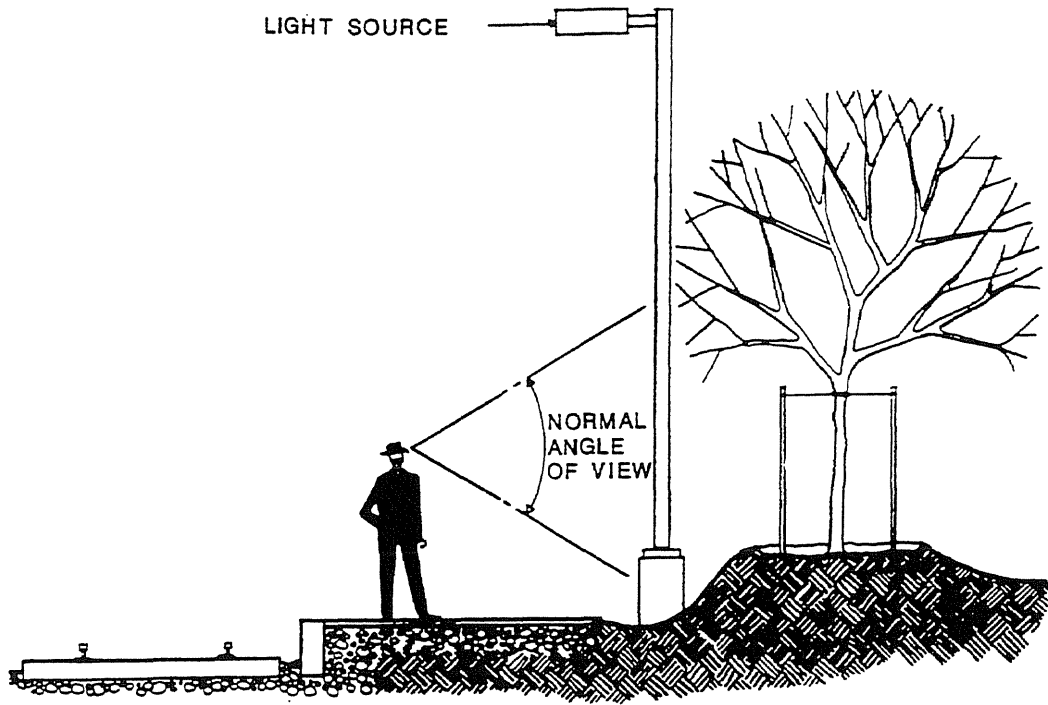

Minimize Reflected Glare by Insuring That Angle of View Exceeds Angle of Reflection

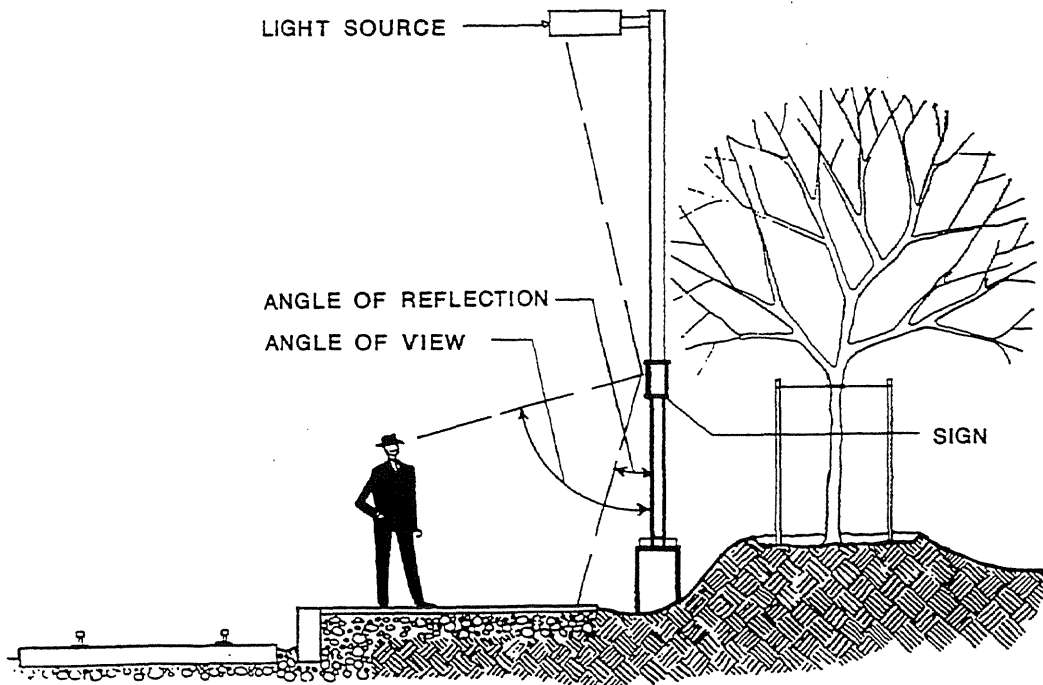

**D. EMERGENCY LIGHTING**

Emergency lighting should be limited to the interior of enclosed station buildings and enclosed stairs. The system should have a self-contained battery pack and should be mounted at a height sufficient to prevent vandalism and to provide adequate emergency lighting with a minimum of fixtures.

**IV. DESIGN CRITERIA AND DETAILS**

**A. GENERAL LUMINAIRES SELECTION CRITERIA**

Luminaires used at commuter stations should meet the following criteria:

- Function effectively for a minimum of 20 years.
- Resist vandalism, with polycarbonate or high impact acrylic diffusers and vandal-proof access devices such as latches, screws, and locks.
- Minimize maintenance time and costs. Replacement of lamps and ballasts shall be easily accomplished. Lamps and ballasts shall be readily available and standardized to the greatest extent possible. All lenses, diffusers, access devices, and fasteners shall be of the captured type; hinged and removable to provide easy access and prevent loss or damage of parts.
- Contain only non-corrosive materials.
- Function effectively within a -20 to + 110 F ambient temperature range (-28 C to +43 C).
- Provide fixture enclosure that keeps moisture and dust out, but allows heat to dissipate.

**B. GENERAL LAMP SELECTION CRITERIA**

1. A variety of lamp types is available today. Three factors should be considered in selecting the lamp type.
  - Lumen/watt efficiency of the lamp.
  - Effect of the light source color on the surface color appearance of the surrounding areas and objects.
  - Mounting flexibility.
2. Due to the effect of light source color on surface color appearance, the result of lamp choice on user perception should be considered. A given lamp's lumen/watt efficiency and mounting flexibility should also be considered.
3. The lamp types available are:
  - a. High Intensity Discharge  
 High Intensity Discharge (HID) is the preferred light source for

 Massachusetts Bay Transportation Authority <b>RAILROAD OPERATIONS</b>	<b>Commuter Rail Design Standards Manual</b>	Stations and Parking	Section II
		<b>Lighting</b>	Chapter 3
Revision No. 1	Date: 4/19/96	Page 3.5	

commuter rail stations because it is highly energy efficient. HID lamps are point light source, electric discharge lamps requiring ballasts. Starting requires several minutes. The preferred HID lamps are:

- Mercury vapor lamps, which emit a greenish-blue light and cause a perceptible shift in color rendition. They are highly efficient (30-65 lumens/watt) with long rated lives (16,000-24,000 hrs.) and excellent lumen maintenance. Mercury vapor lamps are primarily suited to high bay (over 13'-0" mounting height) applications.
- Metal halide lamps, which produce a white light. Color rendition is as least equal to mercury vapor. Metal halide lamps are smaller in size than mercury vapor lamps, yet produce a substantially greater output of lumens/watt.
- High pressure sodium lamps, which emit a distinctly yellow-orange light and have a very perceptible effect on color rendition. High pressure sodium is the preferred HID lamp because it is the most efficient lamp currently available (approximately 100 lumens/watt). It should be used for lighting large exterior areas such as parking lots and walkways. A typical fixture that might be used in these applications is described in accompanying illustrations.

**b. Fluorescent**

- Available in several colors. Warm white fluorescent lamps produce good color rendition and mix well with incandescent. Cool white lamps tend to dull warm colors and intensify cool colors, but are the most efficient (lumens/watt) fluorescent color. Fluorescent is a linear light source characterized by higher light efficiencies, cooler operating temperatures, and longer life expectancies than incandescent.
- Fluorescent lamps are effective in low and medium level lighting applications due to their efficiency and low source brightness. Fluorescent lamps are appropriate under most interior conditions and preferred over incandescent. They are recommended for lighting under canopies and shelters.

**c. Incandescent**

- Incandescent lamps are the least efficient light source (lumens/watt) and should not be used.

 Massachusetts Bay Transportation Authority <b>RAILROAD OPERATIONS</b>	<b>Commuter Rail Design Standards Manual</b>	Stations and Parking	Section II
		<b>Lighting</b>	Chapter 3
Revision No. 1	Date: 4/19/96	Page 3.6	

Fixture Example

ALZAK ALUMINUM REFLECTOR  
(WITH LAMP END SUPPORT-  
LARGE UNIT ONLY)

SPRING STEEL DROP HINGES  
FOR QUICK REMOVAL OF  
DOOR ASSEMBLY

ONE PIECE EXTRUDED SILICONE  
RUBBER GASKET SEAL BETWEEN  
DOOR AND HOUSING

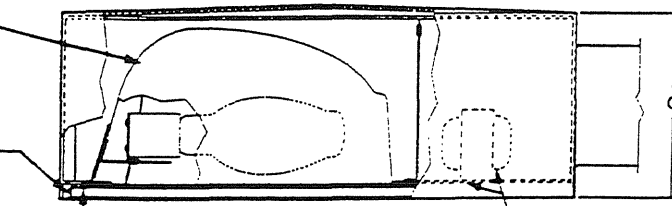

SIDE VIEW

BALLAST AND CAPACITOR  
MOUNT ON INNER ALUMINUM  
DOOR

CAPTIVE QUARTER TURN  
FASTENER ON BALLAST DOOR

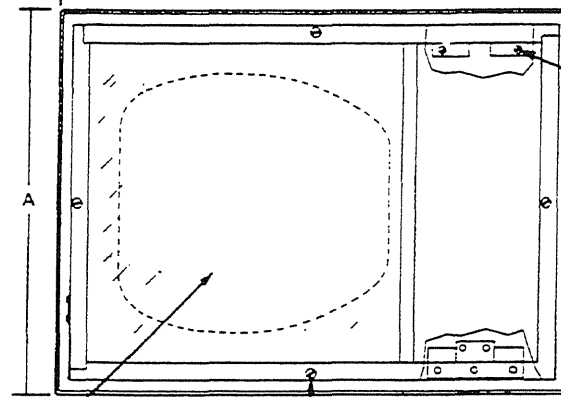

FACE VIEW

POLYCARBONATE LENS

QUARTER TURN FASTENERS

EXAMPLE OF FIXTURE APPROPRIATE  
FOR USE IN PLATFORM, PARKING LOT,  
AND WALKWAY AREAS: CROUSE-HINDS  
ASL SERIES OR EQUAL. RIGHT: TYPICAL  
MOUNTING HEIGHTS FOR FIXTURE OF  
THIS TYPE. 20'-0" TO 30'-0" POLE  
LENGTH IS TYPICAL AT COMMUTER RAIL  
STATIONS.

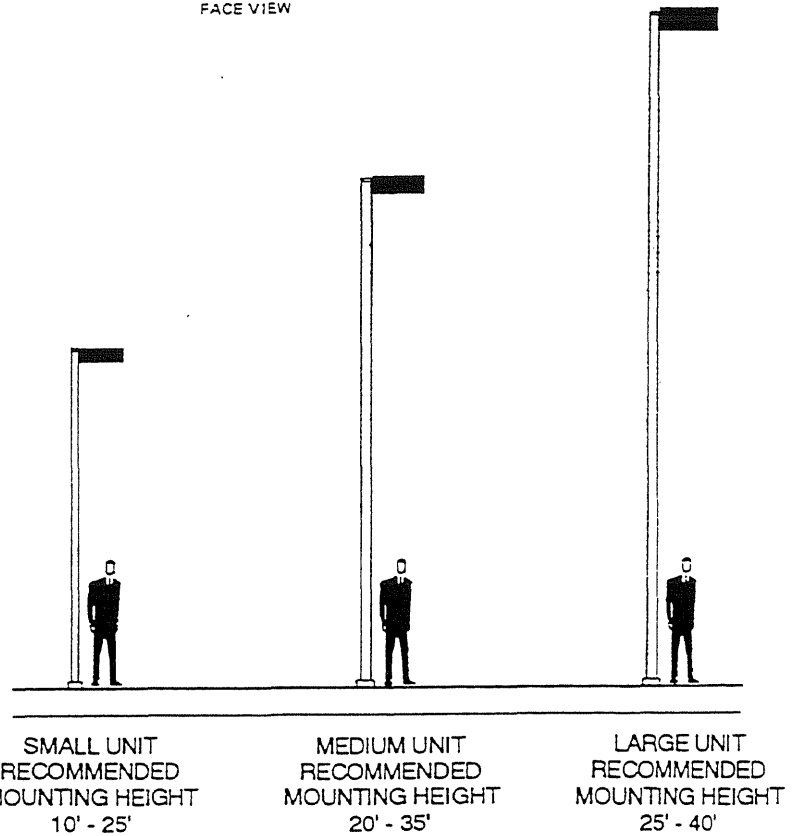

SMALL UNIT  
RECOMMENDED  
MOUNTING HEIGHT  
10' - 25'

MEDIUM UNIT  
RECOMMENDED  
MOUNTING HEIGHT  
20' - 35'

LARGE UNIT  
RECOMMENDED  
MOUNTING HEIGHT  
25' - 40'

 Massachusetts Bay Transportation Authority  <b>RAILROAD OPERATIONS</b>	Commuter Rail Design Standards Manual	Stations and Parking	Section II
		<b>Lighting</b>	Chapter 3
Revision No. 1	Date: 4/19/96		Page 3.7

**C. WIRING**

1. At all sites where regrading or resurfacing is planned, underground wiring shall be used. Underground wiring installed in Fiberglass Reinforced Epoxy (FRE) conduit sized in accordance with then Massachusetts Electrical Code (MEC) is preferred to overhead wiring for reasons of safety, reliability, lower long-term operating cost, and site appearance.
2. Wiring within canopies should be concealed whenever possible.
3. Any exposed wiring must be enclosed in conduit. The conduit should be installed in a manner consistent with the following criteria:
  - o Follow architectural structural members, moldings, or ornamental details in as unobtrusive a manner as possible.
  - o Match the color of the background on which it is mounted.
  - o Resist vandalism with supports at intervals per the MEC within 9'-0" of ground level.

**D. CONTROL COMPONENTS**

1. Lighting control components at commuter rail stations include outdoor control centers and switches.
2. Outdoor control centers shall be provided at all stations. They shall be weatherproof and contain panelboards, lighting contactors, time clocks, and selector switches.
3. Recommended manufacturers of the control center enclosure are Hoffman Engineering Company, Lee Products Co., Russell L. Stroll, the Harry Richmond Company, or equal.
4. Control equipment utilized in commuter rail station lighting systems include:
  - a. Selector Switches
 

Selector switches provide control operation in three positions: Hands-Off- Automatic.
  - b. Photoelectric Sensors
 

Photoelectric sensors are fully automatic and provide illumination from dusk to dawn. Photoelectric switches are particularly applicable at locations where security and safety is a concern, such as shelters, station buildings, and track crossings.

 Massachusetts Bay Transportation Authority <b>RAILROAD OPERATIONS</b>	Commuter Rail Design Standards Manual	Stations and Parking	Section II
		<b>Lighting</b>	Chapter 3
Revision No. 1	Date: 4/19/96	Page 3.8	



c. Time Clocks

Time clocks shall be 24 hour and fully automatic and provide light at pre-set hours. Time clock components include such features as a seven day or astronomical dial, manual bypass lever, and sixteen-hour power reserve units. Time clocks are the most appropriate for parking area and platform lights that need not operate during the entire night. Time clocks shall be equipped with mechanically held contacts.

Typical Detail of a Pole Mounted Lighting Fixture Mounted on a 2'-0" High Concrete Pedestal for Protection from Vehicles

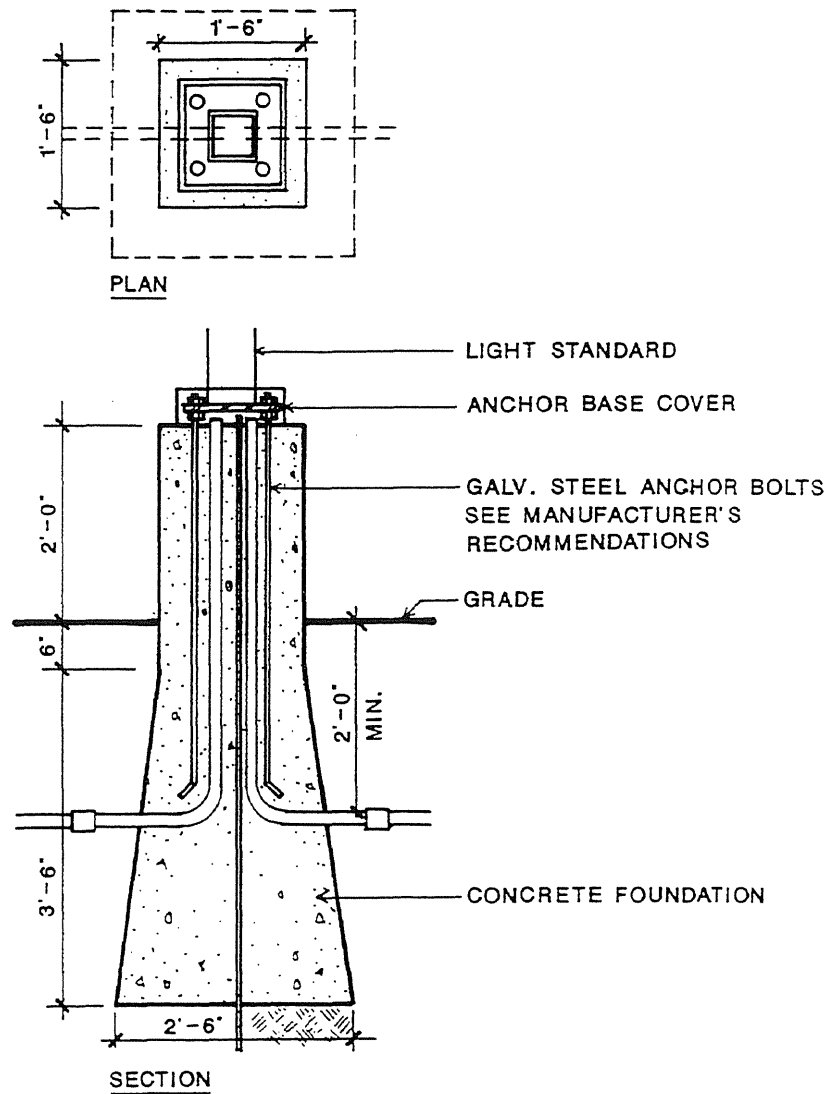

 Massachusetts Bay Transportation Authority <b>RAILROAD OPERATIONS</b>	Commuter Rail Design Standards Manual	Stations and Parking	Section II
		<b>Lighting</b>	Chapter 3
Revision No. 1	Date: 4/19/96		Page 3.9

**E. FIXTURE MOUNTING AND LOCATION**

1. The following general fixture mounting criteria apply to commuter rail stations:
  - o Minimum clearance between the bottom face of the luminaire and ground level is 9'-0"; the preferred minimum clearance is 11'-0".
  - o Placement should be beyond the reach of persons standing on benches, trash receptacles, retaining walls, or other site furniture.
  
2. Criteria listed below apply to pole-mounted fixtures:
  - o Fixture height: minimum of 9'-0" in pedestrian areas (platforms, walkways, etc.), 20'-0" minimum in vehicular areas such as parking lots and roadways; maximum of 30'-0".
  - o Number of fixtures per pole : capable of receiving 1,2,3, or 4.
  - o Location must be accessible for servicing by a bucket truck.
  - o Poles shall be fixed, rather than hinged type base.
  - o Do not use aluminum poles. Experience indicates that they break more readily than the steel pole.
  - o Poles shall have handholes.
  - o Fixture shall have individual cut-off optics.
  - o Poles shall be mounted on a base extending a minimum of 2'-0" above finished grade at locations where poles are susceptible to damage by snowplows or other vehicles.
  - o Shorter poles (20'-0" long) shall be able to resist damage from "whipping" and other acts of vandalism.
  
3. Typical pole-mounted fixtures which meet the above criteria include the Crouse Hinds ASL series, Sterner Lighting Systems (Model Type "Executive 25"), Gardco Lighting (Model Type "Form Ten EH"), or equal.
  
4. Fluorescent fixtures should meet the following criteria:
  - o Be available in standard 4'-0" and 8'-0" lengths.
  - o Provide single or double lamp capacity.
  - o Have a 430 or 800 MA lamp capability.
  - o Have a capability for use as a strip or individual fixture.

---

**CHAPTER 5**  
**COMFORT AND CONVENIENCE FACILITIES**

**I. INTRODUCTION**

This section deals with the types of user comforts and conveniences that should be incorporated into commuter rail stations, such as seating, telephones, and concessions. These facilities, when integrated into the design, make the station more comfortable and convenient.

**II. DESIGN OBJECTIVES**

**A. COMFORT**

Provide facilities that increase the user's comfort while waiting for the train, consistent with the objectives of minimizing targets of vandalism and achieving economy of design.

**B. CONVENIENCE**

Provide facilities that make the station more convenient to use by consolidating activities that might otherwise require several trips (buying a newspaper, making a phone call, etc.) in one location.

**III. DESIGN GUIDELINES**

**A. GENERAL**

Six types of facilities are discussed in this section: seating, telephones, trash receptacles, vending machines and concessions, clocks, and toilet facilities. Some of these facilities should only be included at the most heavily used stations.

At low platform stations with an access platform, platform amenities (seating, etc.) must also be provided on the access platform.

**B. SEATING**

1. Seating should be provided at all stations and designed to provide maximum:

- o Physical comfort
- o Capacity
- o Freedom of choice
- o Durability under exposure to extreme weather conditions and severe vandalism.

2. Capacity Guidelines

- a. The amount of seating required at a station will vary with the shape and size of the site and surrounding facilities. Seating requirements are best established through observation of how other stations are currently used rather than basing the need on

 Massachusetts Bay Transportation Authority  <b>RAILROAD OPERATIONS</b>	<b>Commuter Rail Design Standards Manual</b>	<b>Stations and Parking</b>	<b>Section II</b>
		<b>Comfort and Convenience Facilities</b>	<b>Chapter 5</b>
Revision No. 1	Date: 4/19/96		Page 5.1

## Comfort and Convenience Facilities

overall or peak period ridership. The designer should seek to identify the extent to which people use adjacent facilities, such as restaurants, taxi stands, and their cars when waiting for the train.

- b. The quantity of seating should also be based on observations of sitting patterns, including the spacing people maintain for psychological comfort. Studies indicate that typically 28 people are seated per 100 linear feet of sitting space.

### 3. Location Guidelines

- a. Seating should be located where the user will have easy and direct access to the platform. The user should also have a direct view of approaching trains from the seating.
- b. Avoid locating seating across the tracks from sign units to discourage vandals from throwing objects at the signs while sitting at the station.
- c. Seating should be highly visible from surrounding activities and in a well lighted area for night time use.
- d. Avoid locating seating in areas that will impede pedestrian traffic flow.
- e. Seating should be in a covered location if possible.
- f. Do not locate seating where it may prevent direct approach to signs by users with limited vision.
- g. Seating must conform to AAB requirements to be located at intervals along platforms to not exceed 200 feet.

### C. TELEPHONES

1. A public telephone should be readily accessible at all commuter rail stations, either on site or immediately adjacent to the site.
2. Telephones should be located:
  - o Under shelter or cover where possible
  - o In highly visible (from the station and surrounding area) and heavily traveled areas
  - o Where users can view an approaching train
  - o Where they do not impede or obstruct pedestrian traffic
  - o In areas and at mounting heights accessible to the handicapped
3. Where interior public or banks of (two or more in a single location) telephones are provided, at least one should be TTY equipped. It must be identified with the TTY symbol.

 Massachusetts Bay Transportation Authority  <b>RAILROAD OPERATIONS</b>	<b>Commuter Rail Design Standards Manual</b>	<b>Stations and Parking</b>	<b>Section II</b>
		<b>Comfort and Convenience Facilities</b>	<b>Chapter 5</b>
Revision No. 1	Date: 4/19/96		Page 5.2

**D. TRASH RECEPTACLES**

1. Trash receptacles should be installed at all commuter rail stations, but only if the Authority has negotiated an agreement for the periodic pick-up of trash and maintenance of the receptacles.
2. The receptacles should be located:
  - o In heavily used areas
  - o Where they do not impede pedestrian traffic
  - o At points that are accessible to pick-up crews

**E. VENDING MACHINES AND CONCESSIONS**

1. Currently, the Authority does not install or maintain vending machines or concessions at commuter rail stations. In certain instances, the Authority encourages businesses to lease unused space and provide concessions oriented to users of the system. The following guidelines identify some of the more appropriate types of vending machine services and concessions that might be provided at commuter rail stations, as well as the appropriate locations for these facilities.

2. The types of vending machine services that are most appropriate at a station include:

Newspapers	Snacks-candy, pastries, etc.
Soda	Coffee
Stamps	

With the exception of newspapers, these vending services are generally provided in an enclosed building and are under continuous surveillance by the operator or user of the services. Some of the services also require electricity, plumbing, and heat. Accordingly, vending services other than newspapers should be provided only at those stations with enclosed buildings and that are manned by a ticket agent or a concessionaire.

3. Among the concessions appropriate to a commuter rail station are:

Diners and restaurants	Florist shops
Taxi stands	Real estate offices
Gift shops	Travel agencies
Book stores	Laundry/dry cleaners

Concessions such as these will require an enclosed building. They are generally feasible only when the station has high ridership or is located in an area that has high visibility and traffic volumes.

## Comfort and Convenience Facilities

4. The need for vending machines and concessions should be evaluated on the basis of the availability of these facilities in the vicinity of the station.
5. Vending machines and concessions should be located in areas that are:
  - o Readily accessible to waiting areas and pedestrian walkways along an accessible route.
  - o Easily observed by the station agent (in the case of most vending machine services) or from the surrounding community (in the case of newspaper vending machines.)
6. The facilities should also be located where they do not obstruct views of the platform and approaching trains or impede pedestrian flow.

### F. CLOCKS

Clocks should be provided at all stations with enclosed waiting areas. They should be located where they are readily visible from all parts of the waiting area and conform to ADA standards.

### G. TOILET FACILITIES

1. All manned stations shall have toilet facilities, and at the discretion of the station agent, may be made available to commuter rail passengers. All toilet facilities must comply with the Americans with Disabilities Act Accessibility Guidelines. Toilet facilities open to the public must also comply with the Rules and Regulations of the Architectural Access Board of the Commonwealth of Massachusetts.
2. Toilet facilities shall conform to all building code requirements. Fixtures and accessories required include:
  - 1 sink
  - 1 toilet
  - 1 mirror with shelf
  - 1 electrical outlet
  - 1 soap dispenser
  - 1 tissue dispenser
  - 1 trash receptacle
  - grab bars as required
  - partitions as required
3. The preferred location for toilet rooms in station buildings is adjacent to the main waiting room with access doors directly observable from the agent's office.

 Massachusetts Bay Transportation Authority  <b>RAILROAD OPERATIONS</b>	<b>Commuter Rail Design Standards Manual</b>	<b>Stations and Parking</b>	<b>Section II</b>
		<b>Comfort and Convenience Facilities</b>	<b>Chapter 5</b>
Revision No. 1	Date: 4/19/96		Page 5.4

**IV. DESIGN CRITERIA AND DETAILS**

**A. SEATING**

1. Seating at a station can take many forms, but should meet the following dimensional criteria:
  - o A continuous bench style, at least 7'-6" long, to allow for maximum freedom of choice.
  - o A minimum of 16" and maximum of 20" high
  - o A minimum of 15" in depth
  - o A minimum 3" heel space for ease of rising from a seated position.
  - o To facilitate sitting and rising for people with limited strength and flexibility it is recommended that at least half of the fixed benches at each site have a high back and armrests.
2. The seating should be designed to require a minimum number of vertical supports, thereby reducing the potential for litter collection beneath the seating.
3. Seats should be slatted and sloped from front to back for rain and snow drainage.
4. Seating materials must be highly durable and vandal-resistant, but non abrasive to human contact.
5. Avoid the use of materials such as the extruded aluminum benches found in prefabricated bus shelters and wood of 2" nominal thickness or smaller since they are highly susceptible to vandal damage.

**B. TELEPHONES**

1. Public telephone installations must include at least one telephone per bank (two or more in a single location) that is accessible to people who use wheelchairs, as required by the Rules and Regulations of the AAB and ADAAG. In addition, 25% of the telephones per bank, but never less than one, must have a volume control.
2. Among the other features which each telephone installation should contain are:
  - o Posted numbers listing emergency numbers (police, fire, etc.) and convenience numbers (Authority number for information on service, delays, etc., and local taxis).
  - o A telephone directory, attached to the installation and protected from the weather.
  - o Lighting to read the dial and directory.
  - o A shelf for personal articles such as gloves, purse, change, etc.
  - o TTY

 Massachusetts Bay Transportation Authority <b>RAILROAD OPERATIONS</b>	<b>Commuter Rail Design Standards Manual</b>	Stations and Parking	Section II
		<b>Comfort and Convenience Facilities</b>	Chapter 5
Revision No. 1	Date: 4/19/96		Page 5.5



Typical Bench Construction Details

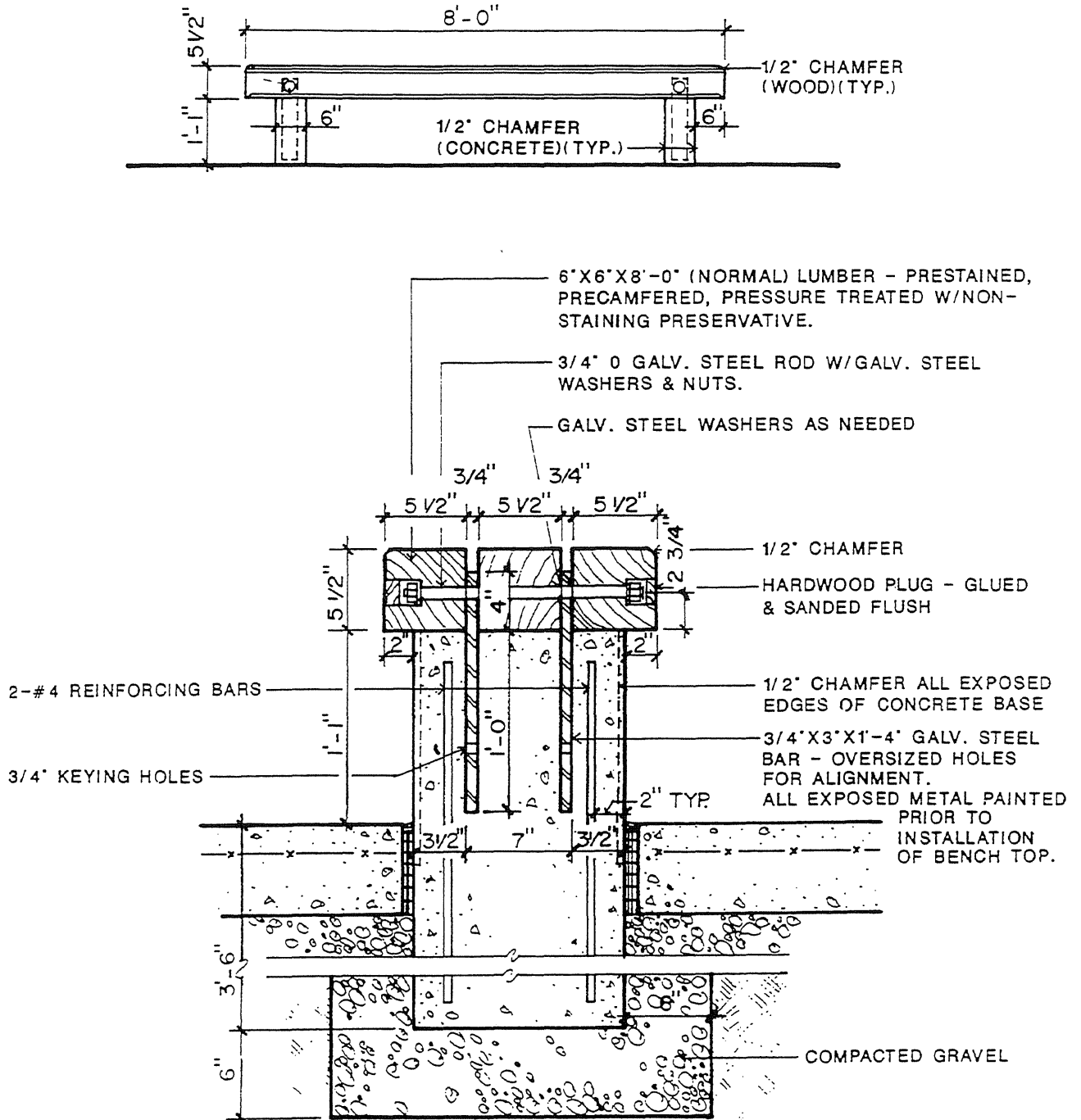

**C. TRASH RECEPTACLES**

1. Trash receptacles should follow the MBTA Commuter Rail standard with locking tops. Refer to previous construction jobs for specifications. They should also have the following features:
  - o Large opening for easy trash disposal
  - o Minimal exposure of opening to rain and wind
  - o High (55 gallon) capacity, self-draining container
  - o Durable material, resistant to the abuse of weather and vandalism
  - o Capability for being affixed to an object such as a utility pole or located within a heavy, immovable container (precast concrete, etc.)

**D. TOILET FACILITIES**

1. Fixtures: all urinals, and sinks shall be wall-hung vitreous china. Fittings should be either stainless steel or chrome-plated brass with concealed or vandal-proof anchors.
2. Accessories: compartment partitions and fittings should be stainless steel. Mirrors should be plate glass with stainless steel frames. All other accessories should be of stainless steel construction with concealed and tamper-proof mounting devices.
3. Room finishes: should be rugged, chemical-resistant, and easily cleaned.
4. Lighting: provide lighting to achieve an average level of 30 foot-candles. Switch should be provided so that the lights are in operation only when the facilities are in use.
5. Ventilation: provide mechanical ventilation to the outdoors with make-up air supply from either louvers or undercuts at the toilet room access doors.
6. Floor drains and wash down facilities should be included where possible.

 Massachusetts Bay Transportation Authority  <b>RAILROAD OPERATIONS</b>	<b>Commuter                  Rail                  Design                  Standards                  Manual</b>	<b>Stations and Parking</b>	<b>Section II</b>
		<b>Comfort and                  Convenience Facilities</b>	<b>Chapter 5</b>  Page 5.7
Revision No. 1		Date: 4/19/96	

---

**CHAPTER 6**  
**LANDSCAPING**

**I. INTRODUCTION**

This section deals with landscaping of the station site. As used in this manual, the term landscaping refers to the existing natural features of a station, as well as additional natural (trees, shrubs, ground cover, etc.) and man-made (fencing, special paving materials, etc.) elements that can be used to enhance the overall visual quality of a station. Proper use of existing station landscaping, when combined with the selective use of new landscape elements, can also help make the site compatible with the surrounding area.

**II. DESIGN OBJECTIVES**

The principal objectives of the site landscaping are increased attractiveness, user safety and security, preservation of significant existing features, durability/maintainability of the landscape elements, and soil conservation.

**A. ATTRACTIVENESS**

Provide an attractive station environment by using landscaping to 'soften' the effect of large paved areas, integrate the station into compatible surrounding areas, and buffer the station from incompatible surroundings.

**B. SAFETY AND SECURITY**

Use landscaping elements to improve the safety of pedestrian and vehicular movements and to maximize surveillance of the station (and enhance user security) from the surrounding area. Note that enhancing security through increased station visibility from the surrounding area may conflict with requirements to buffer the site from incompatible surroundings.

**C. PRESERVATION**

Preserve and capitalize on existing site assets such as trees, water, views, or historic buildings.

**D. DURABILITY/ MAINTAINABILITY**

Use landscaping suited to the climate, resistant to vandalism, and low in maintenance requirements.

**E. SOIL CONSERVATION**

Provide adequate storm water drainage facilities that minimize uncontrolled water run-off and minimize soil erosion on and off site.

 Massachusetts Bay Transportation Authority  <b>RAILROAD OPERATIONS</b>	<b>Commuter                  Rail                  Design                  Standards                  Manual</b>	Stations and Parking	Section II
		<b>Landscaping</b>	Chapter 6
Revision No. 1	Date: 4/19/96	Page 6.1	

**III. DESIGN GUIDELINES**

**A. GENERAL**

Three areas of concern addressed in this section are: buffers, site drainage and planting. Site improvements in each of these categories may contribute to the achievement of the attractiveness, safety, security, preservation, and soil conservation objectives. All of the design guidelines pertaining to each of the categories are aimed at satisfying the fifth objective—durability and maintainability of the site improvements.

**B. BUFFERS**

1. Buffers include various types of natural and man-made devices that can be used to visually screen incompatible land uses (such as a station parking lot from adjacent residences) or to attenuate the noise emanating from trains.
2. Among the visual screening devices that may be used are:
  - a. Site topography: at some stations it may be possible to use substantial grade changes on the site to visually screen parking from the surrounding area. However, it is necessary to maintain the visibility of the parking lot at all times, in order to increase the feeling of security and discourage vandalism and crime.
  - b. Earth berms: where a relatively level site does not permit the use of site topography, earth berms, as illustrated on the following page, may be used as a screening device. They are generally a minimum of 3'-0" high and require a minimum of 20'-0" horizontal distance to achieve proper slope ratios for the minimum height berm. They are typically planted with a low maintenance ground cover, described later in this section.
  - c. Planting: sticker-bushes, hedgerows, and trees may be used as a partial visual screen. The general effect of planting will be to lessen the visual impact of the station on the adjacent area, rather than to create a complete blockage of sight lines between the station and the surrounding area. Maintaining at least partial station visibility from the surrounding area is important to enhancing personal security at the station. Appropriate plant materials are described later in this section.
  - d. Fencing: another means of visual screening is accomplished through the use of fencing. Opaque fencing material - solid wood fencing and masonry walls are examples - is typically very expensive and difficult to maintain. Consequently, the use of fencing as a screening device is not recommended at commuter rail stations and should be used only when the other three approaches are found to be unsuitable to a site.

 Massachusetts Bay Transportation Authority  <b>RAILROAD OPERATIONS</b>	Commuter Rail Design Standards Manual	Stations and Parking	Section II
		<b>Landscaping</b>	Chapter 6
Revision No. 1	Date: 4/19/96		Page 6.2

Site Topography as a Screening Device

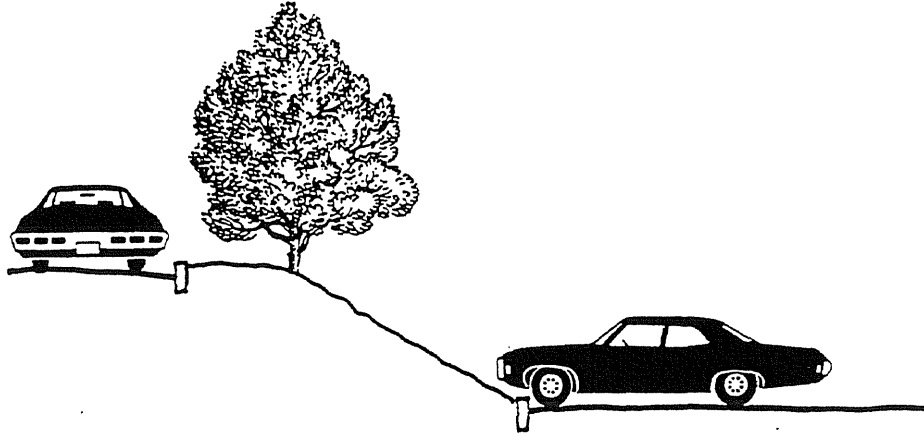

Berms as a Screening Device

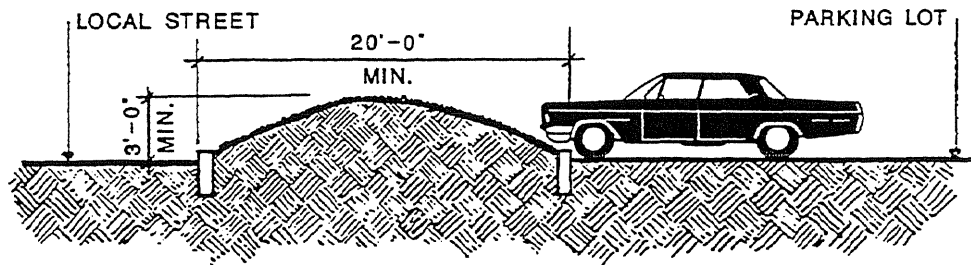

 Massachusetts Bay Transportation Authority  RAILROAD OPERATIONS	Commuter Rail Design Standards Manual	Stations and Parking	Section II
		<b>Landscaping</b>	Chapter 6
Revision No. 1	Date: 4/19/96		Page 6.3

3. The Federal Environmental Protection Agency has formulated standards for the noise levels of railroad rolling stock. The proposed standards are 88dBA for rolling stock operating at up to a 72 kph (45 mph) and 93 dBA for speeds greater than 72 mph, as measured at a distance of 30 meters (100'-0").
  
4. Two approaches to alleviating noise impacts are described below:
  - a. Berms and walls: a high percentage of rail right-of-way noise is generated at track level. Earth berms or walls located immediately adjacent to the tracks will partially deflect or absorb this noise and reduce noise levels on abutting properties.
  
  - b. Visual screening: in some instances it has been noted that a major component of the noise problem is the result of a psychological rather than a physiological reaction to the noise—i.e., viewing the source of the noise becomes a disproportionately large part of the problem. In these cases, it may be possible to mitigate the impact through the use of densely planted shrubs and trees, especially evergreens. Note, however, that these materials do little to alleviate the noise.
  
5. Location Guidelines
  - a. The location of visual screening devices will, of course, vary with the site. In general, however, they should be located at the perimeter of the site.
  
  - b. Maintain a 10'-0" distance between walkways, platforms, and parking areas and new or existing dense vegetation.
  
  - c. Locate buffers in a manner that insures undisturbed visibility at all pedestrian and vehicular intersections.
  
  - d. Select tree species whose lowest branch height is 7'-0" or greater.
  
  - e. Insure that the landscaping does not reduce the effectiveness of the site lighting.
  
  - f. Avoid screening the platform waiting areas from the surrounding neighborhood and streets.

 Massachusetts Bay Transportation Authority  <b>RAILROAD OPERATIONS</b>	Commuter Rail Design Standards Manual	Stations and Parking	Section II
		<b>Landscaping</b>	Chapter 6
Revision No. 1	Date: 4/19/96	Page 6.4	

**C. SITE DRAINAGE**

1. As used in this chapter of the manual, the term site drainage refers to actions required to manage storm water in both paved and unpaved areas of a station site. Stations should have storm drainage systems that connect to municipal systems. Much of the storm water flows to existing street catch basins or is simply absorbed by the soil on-site. All plans for upgrading a station drainage system must be coordinated with local public works departments and conservation commissions.
  
2. Station improvements, especially parking, create a substantial increase in paved area and may also disrupt natural drainage patterns. The following guidelines establish a preferred approach to dealing with the issues of grade modifications, drainage of paved areas and unpaved areas, and slope control.
  
3. Grade Modification Guidelines
  - a. The grading design should balance the aesthetic, drainage, maintenance, and operational needs of the station site.
  - b. Coordinate proposed grades with plant material to remain (such as larger trees) and with other existing site elements.
  - c. The grading design should attempt to balance cut and fill.
  - d. Design slopes within minimum and maximum tolerances to insure positive drainage, ease of maintenance, and prevention of erosion.
  - e. Grading Around Trees to be Preserved
    - o The maximum fill allowed within the drip line of any tree (the area encompassed by the tree's longest branches) shall be 6". No cut shall be permitted within the drip line area.
    - o When more than 6" of fill is required, the tree should be removed. In the case of significant specimens, protect with a terrace or drywell.
    - o Provide positive drainage away from the base of all trees.
  
4. Drainage of Paved Areas
  - a. In general, all new or rehabilitated parking lots at commuter rail stations should have a storm drainage system connecting with an existing municipal system.
  - b. Minimum and maximum slopes in paved areas will vary with the material and location, but should be as prescribed in the Circulation and Parking sections of this manual.

 Massachusetts Bay Transportation Authority <b>RAILROAD OPERATIONS</b>	<b>Commuter Rail Design Standards Manual</b>	Stations and Parking	Section II
		<b>Landscaping</b>	Chapter 6
Revision No. 1	Date: 4/19/96		Page 6.5



## Landscaping

- c. Design flows for the system should be determined by using the Rational Method (or an accepted alternative) and as detailed in Manual No. 37, Design and Construction of Sanitary and Storm Sewers, American Society of Civil Engineers.
- d. The selection of a particular storm frequency and discharge capacity should be based upon the need for maximum reliability of operation, consistent with economy and local experience. The following chart can be used as a guide in determining the storm frequency.

Storm Frequency in Years	Drainage System Element
5	Secondary ditches
10	Median ditches, gutters, ditch inlets, curb and paved area inlets, and inlet ponding
25	All pipes and culverts except under major roads and culvert outlets
50	Relocated stream channels, major stream structures, transverse pipes, culverts, etc. under major roads
100	Use only when required by the local agency

- e. Hydraulics: in the design of a storm drain system, the following factors should be considered:
  - o Topography: avoid designs that require pumping
  - o Economy of construction: avoid excessively deep cuts
  - o Peak flows
  - o Slopes: determine slopes required for proper self-cleaning at minimum flows
  - o Minimum pipe size: 12 inches
  - o Maximum velocity: up to 10 feet per second
  - o Hydraulic design should be in accordance with manual No. 37, Design and Construction of Sanitary and Storm Sewers, American society of Civil Engineers. Coefficients of roughness should be as recommended in that manual.
- f. Gravity Flow: provide a self-cleaning velocity of 2 feet per second. Where this minimum is impractical to obtain, the design should consider the effects of sedimentation, odors, and operational difficulties at lower velocities.
- g. Water Collection
  - o As illustrated in the diagram, continuous sheet flow of water into a swale located along an edge of flat areas,

followed by the collection of this water in several area drains, is desirable. Area drains connected by ridges and valleys break up the continuity of paved surfaces and should be avoided.

- If area drains must be used, avoid strong linear paving patterns and reduce the pitch of the paving to the minimum.
- Trench drains are very expensive and should only be used where the collection of water in a small number of area drains is not practical, such as at the foot of some stairs and ramps.
- Coordinate the site drainage pattern with the design of barriers and curbs. For example, at some locations water from paved areas may flow to adjacent unpaved areas and be absorbed by the soil. In this situation, guard rail or bollards should be used instead of curbing as a barrier system at the edge of paved areas to prevent vehicles from destroying vegetation in the unpaved area.
- Coordinate drainage of the site with drainage of the track and roadbed to insure that water from one does not cause problems with the other.
- Where the presence of salt is likely, do not pitch the pavement to flush or recess planting areas.
- Avoid sheet flow across walks, ramps, and stairs.

**5. Drainage of Unpaved Areas**

- a. Unpaved or planted areas should be designed to absorb normal rainfall without draining onto paved areas. In areas with steep, planted slopes, horizontal run outs should be incorporated into the design to absorb the water run-off before it reaches a paved area.
- b. The range of acceptable natural slopes in unpaved areas is presented in the following chart.

 Massachusetts Bay Transportation Authority <b>RAILROAD OPERATIONS</b>	<b>Commuter Rail Design Standards Manual</b>	Stations and Parking	Section II
		<b>Landscaping</b>	Chapter 6
Revision No. 1	Date: 4/19/96	Page 6.7	

## Landscaping

Type of Ground Cover	Maximum Slope	Desirable Maximum Slope	Minimum Slope	Desirable Slope
Mowed Lawn	3:1	4:1	1%	2%
Unmowed Lawn and Ground Cover Areas	3:1 (if jute mat used)	3:1 (Fill slope) 2:1 (cut slope)	2%	3%

### D. PLANTING

1. The use of plant materials at commuter rail stations is one of the most effective means of enhancing the visual quality of a station, while at the same time performing an essential soil conservation function.
2. An important consideration in a station improvement program is the preservation of significant existing natural features- trees, shrubs, etc. By capitalizing on these features, new planting costs can often be kept to a minimum and concerned abutters may be reassured that the physical character of the site will not change dramatically. Among the actions that should be taken to preserve existing natural features are:
  - a. Wherever grading requires a cut of more than 6" or a fill of more than 4" at sites with good topsoil, the topsoil should be stripped and stored for later use.
  - b. Care should be taken in the scheduling and techniques of earth moving operations to insure that erosion of soil does not take place. Slopes that must remain unplanted or unfinished for substantial periods should have their soils stabilized with mulches, fast-growing temporary ground covers (rye, grass, or buckwheat) or man-made soil stabilizers (such as jute mats).
  - c. In areas that are to be cleared and grubbed, an analysis of all trees 2" and larger in diameter should be performed. Where possible, sound specimens of either soft or hardwood trees should be identified. They should be thinned to a minimum of 10'-0" on center and tagged for preservation. Exceptions to the thinning may be natural clumps of trees such as birches.

3. Types of Planting

- a. Public areas in general and transit stations in particular can be difficult environments for the growth of plant material. Abuse by vandals, intense exposure to both vehicular and pedestrian traffic, and minimal maintenance all contribute to the condition.
- b. The list of recommended plant materials (on the following page), developed by the American Horticultural Society in the report Transit Planting: A Manual, accounts for these problems. The report's criteria for selection are:
  - o Climatic zone suitability
  - o Durability (including pollution resistance)
  - o All year performance
  - o Long life span
  - o Low-cost maintenance
  - o Artistic utilization and availability
- c. This list is not necessarily a definitive list for all planting that may be used at stations. Most of the materials were chosen for durability in urban locations or proximity to parking or roads. Many of the Authority's commuter rail stations are in suburban or rural areas without the major impact of vehicular and city pollution. Many of these stations have fine specimens of indigenous plant material. Consequently, the designer should also consider plantings that have already proven their suitability for a particular site.
- d. Plant materials should require little care other than initial planting and cultivation. Grass should not be used except in those cases where the Authority enters into agreements with municipal or commercial establishments to provide maintenance, or where the appearance of uncut grass is not objectionable. Bushes and shrubs should not require trimming or pruning. Fruit bearing trees should also be avoided.

4. Location of Planting

- a. Planting materials can reinforce the pedestrian circulation, but for the most part, cannot control it. Careful planning of access points to the site and platform area will help insure that planting areas do not become "short cut" paths.

 Massachusetts Bay Transportation Authority <b>RAILROAD OPERATIONS</b>	<b>Commuter Rail Design Standards Manual</b>	Stations and Parking	Section II
		<b>Landscaping</b>	Chapter 6
Revision No. 1	Date: 4/19/96	Page 6.9	

Recommended Plant Materials

TREES

<u>Acer platanoides</u>	(Norway Maple)
<u>Acer rubrum</u>	(Red Maple)
<u>Amelanchier canadensis</u>	(Serviceberry)
<u>Carpinus betulus</u>	(European Hornbeam)
<u>Cornus mas</u>	(Cornelian Cherry)
<u>Fraxinus pennsylvanica</u>	(Green Ash)
<u>Ginkgo biloba</u>	(Ginkgo)
<u>Halesia carolina</u>	(Carolina Silverbell)
<u>Ilex opaca</u>	(American Holly)
<u>Koelreuteria paniculata</u>	(Goldenrain-tree)
<u>Liquidambar styraciflua</u>	(Sweet-Gum)
<u>Phellodendron amurense</u>	(Amur Cork-tree)
<u>Pyrus calleryana 'Bradford'</u>	(Bradford Pear)
<u>Quercus phellos</u>	(Willow Oak)
<u>Sophora japonica</u>	(Japanese Pagoda-tree)
<u>Tilia cordata</u>	(Littleleaf-Linden)

SHRUBS

<u>Abelia grandiflora</u>	(Glossy Abelia)
<u>Acanthopanax sieboldianus</u>	(Aralia)
<u>Berberis thunbergii</u>	(Japanese Barberry)
<u>Buxus microphylla</u> var. <u>japonica</u>	(Japanese Boxwood)
<u>Chioanthus virginicus</u>	(Fringe-tree)
<u>Deutzia gracilis</u>	(Slender Deutzia)
<u>Elaeagnus angustifolia</u>	(Russian Olive)
<u>Forsythia x intermedia</u>	(Forsythia)
<u>Ilex crenata</u>	(Japanese Holly)
<u>Juniperus chinensis "Pfitzerianas"</u>	(Pfitzer Juniper)
<u>Kolkwitzia amabilis</u>	(Beautybush)
<u>Rhus copallina</u>	(Shining Sumac)
<u>Spiraea x vanhouttei</u>	(Vanhouette Spirea)
<u>Taxus cuspidata</u>	(Japanese Yew)
<u>Xanthorrhiza simplicissima</u>	(Yellowroot)

GROUND COVERS

<u>Ajuga reptans</u>	(Bugleweed)
<u>Arctostaphylos uva-ursi</u>	(Bearberry)
<u>Cotoneaster horizontalis</u>	(Rockspray Cotoneaster)
<u>Epimedium sp.</u>	(Forsythia)
<u>Hedera helix</u>	(English Ivy)
<u>Hemerocallis sp.</u>	(Daylily)
<u>Ilex crenata</u>	(Japanese Holly)
<u>Juniper chinensis 'Pfitzerianas'</u>	(Pfitzer Juniper)
<u>Lonicera japonica</u>	(Japanese Honeysuckle)
<u>Rosa wichuraiana</u>	(Memorial Rose)
<u>Sedum acre</u>	(Goldmoss Stonecrop)
<u>Vinca minor</u>	(Periwinkle)

 <p>Massachusetts Bay Transportation Authority</p> <p>RAILROAD OPERATIONS</p> <p>Revision No. 1      Date: 4/19/96</p>	<p>Commuter Rail Design Standards Manual</p>	Stations and Parking	Section II
		Landscaping	Chapter 6
		Page 6.10	

- b. Shrubs should be planted so that when mature, they will not overhang walkways or platform areas.
- c. Trees that overhang walkways and waiting areas should be of a species whose lower limbs are of sufficient height to allow comfortable pedestrian circulation.
- d. In general, trees should be clustered in designated areas of a parking lot rather than scattered throughout the lot. In all cases, trees planted adjacent to parking areas should be carefully protected with bollards or curbs.
- e. Where traffic islands or planted strips are located within parking areas, plant materials should be selected with snow removal in mind. Plants should also not grow high enough to obstruct motorist's view. The planting must be able to bear the weight of accumulated snow, and trees should be planted a minimum of 8'-0" from the curb edge where snow would be deposited by plows, and small bushes should be avoided. In general, only low, hardy ground covers, grass, or non-plant ground covers should be used. Do not locate trees or other plant materials at random throughout a parking area because of these snow problems and the loss of space that can be used for parking. Concentrate planting in a few areas with a high visual impact.
- f. Non-Plant Ground Covers
  - o Fabric weed barriers: Used before ground covers are applied. It is also used to keep mulch on sloped areas from sliding down.
  - o Small stones or gravel: Also used as a ground cover.
  - o Mulch: There are two general categories of mulch. Grass mulch consists of salt marsh hay or straw and is applied using an asphaltic binder, which holds the soil together until the seed is established. This mulch may also be used as a temporary soil erosion measure during construction. Bedding mulch is used to keep down weeds and to retain surface moisture around trees and shrubs. It also provides an attractive uniform ground plane surface. Three types of bedding mulch may be used:
    - o Wood chips from local sources are usually the cheapest form of mulch and provide a coarse, light-gray appearance. Wood chips vary greatly in quality.
    - o Pine bark mulch provides a darker, more uniform color and has a fine texture. It tends not to stay in place on sloping surfaces.
    - o Fir chunk bark mulch is the most expensive mulch, but it provides excellent uniform color and texture. Larger dimension and weight gives it a longer life span than the other mulches.

 Massachusetts Bay Transportation Authority <b>RAILROAD OPERATIONS</b>	<b>Commuter Rail Design Standards Manual</b>	Stations and Parking	Section II
		<b>Landscaping</b>	Chapter 6
Revision No. 1	Date: 4/19/96	Page 6.11	

**IV. DESIGN CRITERIA AND DETAILS**

**A. GENERAL**

Design criteria are described in this section for site drainage and planting. Since the design of these items tends to be site specific, only general criteria are presented below.

**B. SITE DRAINAGE**

1. Materials

- a. General Guidelines: the selection of the type of pipe to be utilized should be governed by the following factors:
  - o Permanency of the facility
  - o Static and impact loads which the pipe must sustain
  - o Physical and chemical characteristics of soil
  - o Physical and chemical characteristics of fluids
  - o Availability of materials and the relative economics of construction of the installation
  - o Initial cost versus maintenance cost of the system
- b. All materials and installation methods shall conform with the Commonwealth of Massachusetts Department of Public Works Standard Specifications for Highways and Bridges.

2. Storm Drainage Pipe

- a. Materials and structural requirements shall be detailed in Manual No. 37, Design and Construction of Sanitary and Storm Sewers, American Society of Civil Engineers.
- b. Class shall be as required for strength.
- c. Acceptable types of pipe are cast iron, reinforced concrete (both circular and elliptical), asbestos-coated corrugated metal. Where the base metal of the corrugated pipe is steel, it shall be galvanized.

3. Manholes, Basins, and Inlets

- a. Provide manholes at maximum intervals of 300'-0" for drains 48" or smaller, and 600'-0" for drains 54" and larger. Minimum inside diameter shall be 4'-0". Minimum wall thickness shall be as required for depth of structure, but in no case less than 5".
- b. Provide manholes at every junction, change in alignment, or change in grade of all drains.
- c. All collection structures shall be self-cleaning and draining. Do not use cushions because of insect and odor problems.

 Massachusetts Bay Transportation Authority <b>RAILROAD OPERATIONS</b>	Commuter Rail Design Standards Manual	Stations and Parking	Section II
		<b>Landscaping</b>	Chapter 6
Revision No. 1	Date: 4/19/96	Page 6.12	

- d. Each culvert or drain 15" or more in diameter shall be provided with a secured, but removable bar screen at the inlet and outlet structure to prevent children from crawling into the pipe. To reduce clogging of the inlet screen, use sloped vertical bars so that debris will ride up the bars during flow.
- e. All structures other than inlets shall be provided with steps meeting OSHA requirements. Minimum access opening shall be 22".
- f. Drainage inlets in curbed roadways shall be curb type inlets.
- g. Provide wing walls at inlets and outlets to improve flow. Energy dissipaters, flared ends, and erosion protection such as rip rap, gabion walls, or paved aprons should be utilized where flows can be expected to scour down-stream channels.
- h. All grates, covers, and lids shall be cast iron with no primer or coatings. All inlet grates located in roadways and walkways should be designed to avoid trapping bicycles.

**C. PLANTING**

- 1. The American Horticultural Society, in the report referenced earlier in this subsection, identifies five types of plant material and three areas of a station in which plantings might be used.
- 2. Plant Types
  - a. Large trees: deciduous trees which reach the most monumental proportions, are long lived, and are suitable for planting as space definers and shade producers.
  - b. Small trees: deciduous flowering trees which, at mature height and branching structure, are most likely to conflict with space required for pedestrians unless they are sited properly.
  - c. Evergreen trees: coniferous evergreen forest species with a large mature height.
  - d. Shrubs: deciduous or evergreen, broadleaf or coniferous, which are adaptable to local conditions and retain their form without pruning.
  - e. Ground cover: typical are the evergreen perennials with a dwarfed or prostrate condition and which are adaptable to local conditions.

 Massachusetts Bay Transportation Authority <b>RAILROAD OPERATIONS</b>	<b>Commuter Rail Design Standards Manual</b>	Stations and Parking	Section II
		<b>Landscaping</b>	Chapter 6
Revision No. 1	Date: 4/19/96	Page 6.13	



Plant Material Usage

Description/Usage		Large Trees	Small Trees	Evergreen Trees	Shrubs	Ground Covers
Mature height <sup>1</sup>		75'- 0" or greater	25'- 35'	50'- 0"	20'- 0" <sup>2</sup>	24"
Mature spread <sup>1</sup>		50'- 0" or greater	20'- 35'	35'- 0"	15'- 0"	Up to 6'- 0"
Station Entry Zone	Minimum size at planting	4"- 5" caliper	3"- 3 1/2" caliper	NA	3'- 5' height 3'- 5' spread	2-year plants or 24" spread
	Minimum branch height	7'- 0"	4'- 6"	NA	NA	NA
General Circulation	Minimum size at planting	3"- 3 1/2" caliper	NA	NA	3'- 0" height 3'- 0" spread	2-year plants or 20" spread
	Minimum branch height	6 - 0"	NA	NA	NA	NA
Peripheral Areas	Minimum size at planting	3"- 3 1/2" caliper	2"- 2 1/2" caliper	3"- 3 1/2" caliper	3'- 0" height 3'- 0" spread	2-year plants or 20" spread
	Minimum branch height	5'- 0"	3'- 0"	NA	NA	NA
Minimum spacing (massing and screening)		20'- 0" o.c. <sup>3</sup>	10'- 0" o.c.	10'- 0" o.c.	2 1/2'- 3' o.c.	12" o.c. or 24" o.c.
Minimum spacing (in circulation spaces)		25'- 0" o.c.	NA	NA	2 1/2'- 3' o.c.	12" o.c.
Maximum spacing (in circulation spaces)		45'- 0" o.c.	NA	NA	5'- 0" o.c.	24" o.c.

- 1 Mature height and spread as listed in Trees for American Gardens and Shrubs for American Gardens by Donald Wyman. While it is understood that in urban conditions plants do not reach their normal mature heights and spread, the dimensions listed in this table shall be used in conjunction with the height and spread dimensions listed in Wyman's books for the purpose of specie selection.
- 2 5'- 0" in station entry zone.
- 3 On center.

3. Station Areas for Planting
  - a. Station entry zone: the area adjacent to primary access street, including the main vehicular and pedestrian access and drop-off area(s).
  - b. General circulation: all secondary pedestrian access routes, including plantings within parking areas and adjacent to platforms.
  - c. Peripheral Areas: areas not used by pedestrians or vehicles that either need general ground covers or that provide the opportunity to screen the station from the surrounding community.
  
4. The matrix on the preceding page identifies the preferred size and location of each type of planting in each station area.
  
5. Planting Requirements
  - a. Existing topsoil at each location should be examined to determine suitability for use in planting areas. Acceptable topsoil is defined as a friable loam, neither heavy in clay nor light in sand, containing a minimum of 3% organic matter and having an acidity range of (pH) 5.5 to 7.5. If the soil is found unsuitable, it shall either be improved to an acceptable state or removed from the planting area and replaced with a new soil meeting these criteria.
  - b. Soil of good fertility and friability shall be provided for the top 6" of lawn areas, the top 12" in shrub and perennial beds, and in a zone of 12" around the root balls of all trees, as illustrated on following pages.
  - c. Planting should be designed to survive without any supplemental irrigation after the first year.
  - d. Grasses may be either mowed or un-mowed. Mowed grasses used near circulation areas should be of a high quality perennial seed mix suitable to the locality and site conditions. Un-mowed grasses should be coarser grasses and may have non-grass flower species mixed in.
  - e. Sod may be used to establish grass areas where economics dictate or when it is desirable to use seed mixes not available as sod. When sod is applied on slopes greater than 4:1, use jute matting. All seeded areas should be mulched.

- f. Broadleaf ground cover and bedding plants should be planted using 2" peat pots and spaced 12" to 18" apart in each direction. Coniferous ground covers should be containerized plants with a minimum of an 18" to 24" spread and planted between 2'-0" and 3'-0" apart. All beds for ground cover and bedding plants should be covered with 3" of bark mulch.
- g. Do not use plant material of a type, or in a location, where it will spread into the track area and foul the ballast and drainage. Chemicals that kill vegetation are often used along the track right-of-way to eliminate unwanted plant material.

6. Tree Grates

All tree grates shall be cast iron with no primers or coatings. They should be round or square, such as those illustrated on the following pages.

 Massachusetts Bay Transportation Authority	RAILROAD OPERATIONS	Commuter Rail Design Standards Manual	Stations and Parking	Section II
			Landscaping	Chapter 6
Revision No. 1	Date: 4/19/96			Page 6.16

Typical Tree Planting Detail in Unpaved Area

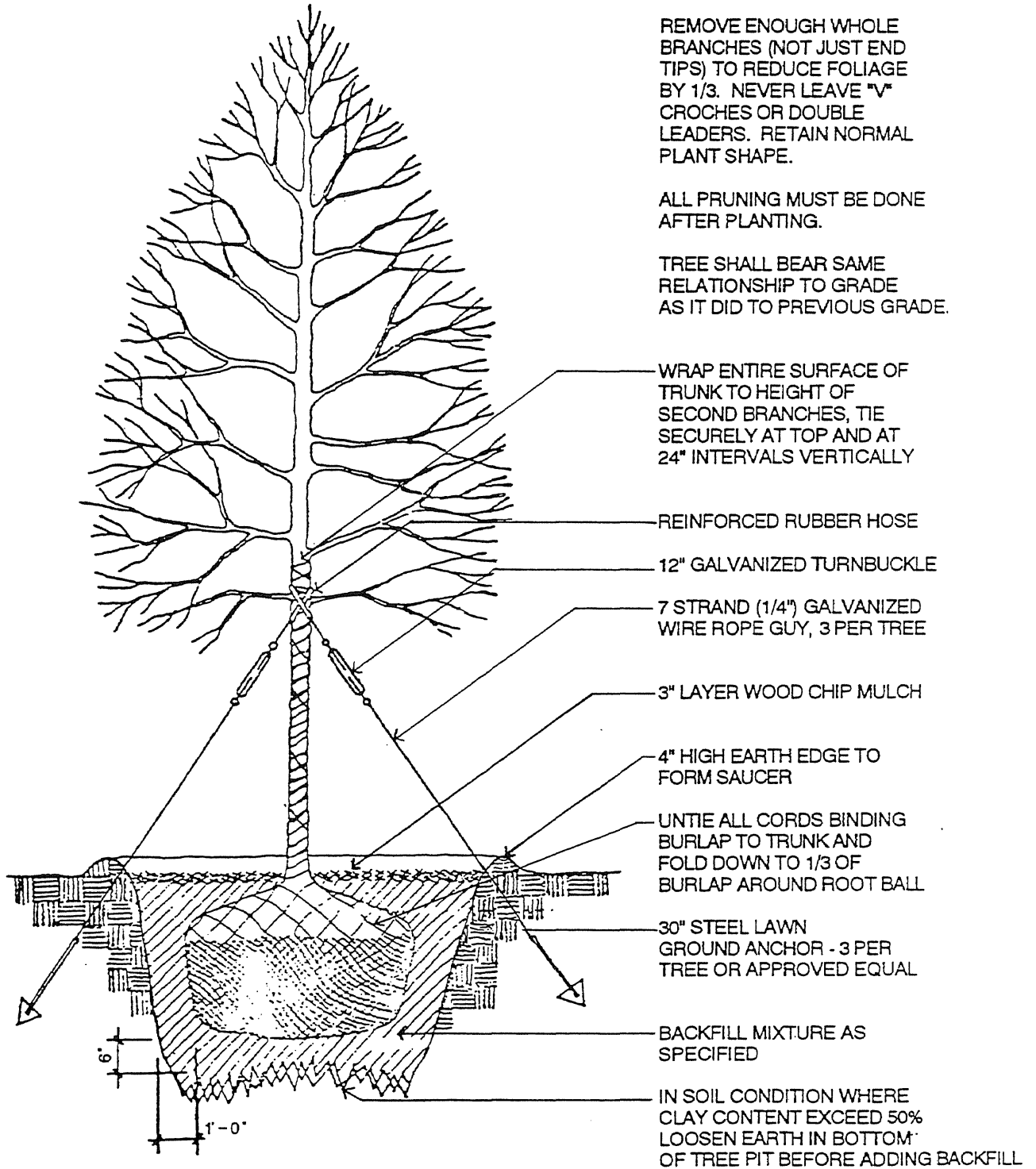

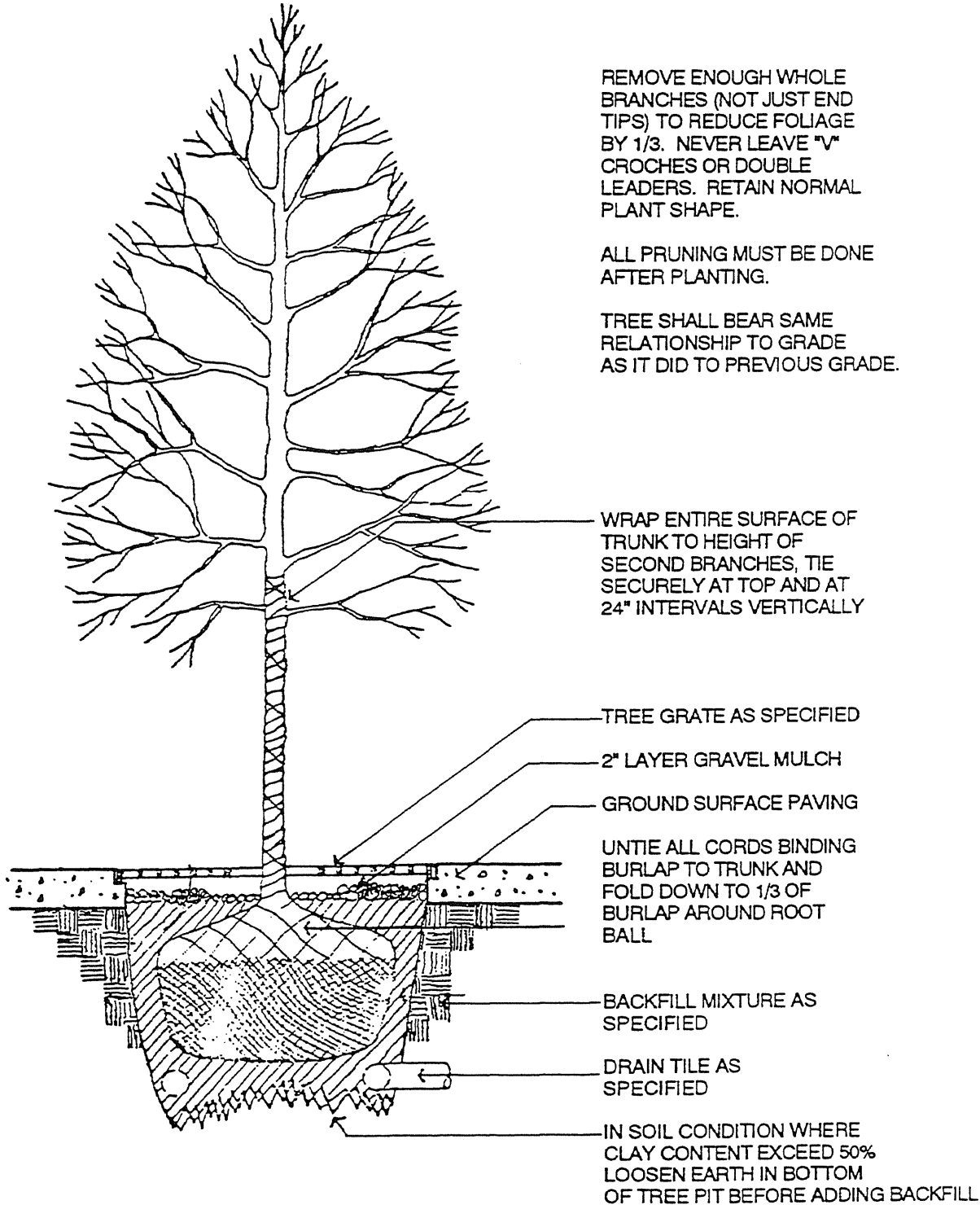

 <p>Massachusetts Bay Transportation Authority</p> <p>RAILROAD OPERATIONS</p> <p>Revision No. 1      Date: 4/19/96</p>	<p>Commuter Rail Design Standards Manual</p>	Stations and Parking	Section II
		<p>Landscaping</p>	<p>Chapter 6</p> <p>Page 6.17</p>

Typical Planting Detail Using Tree Grate

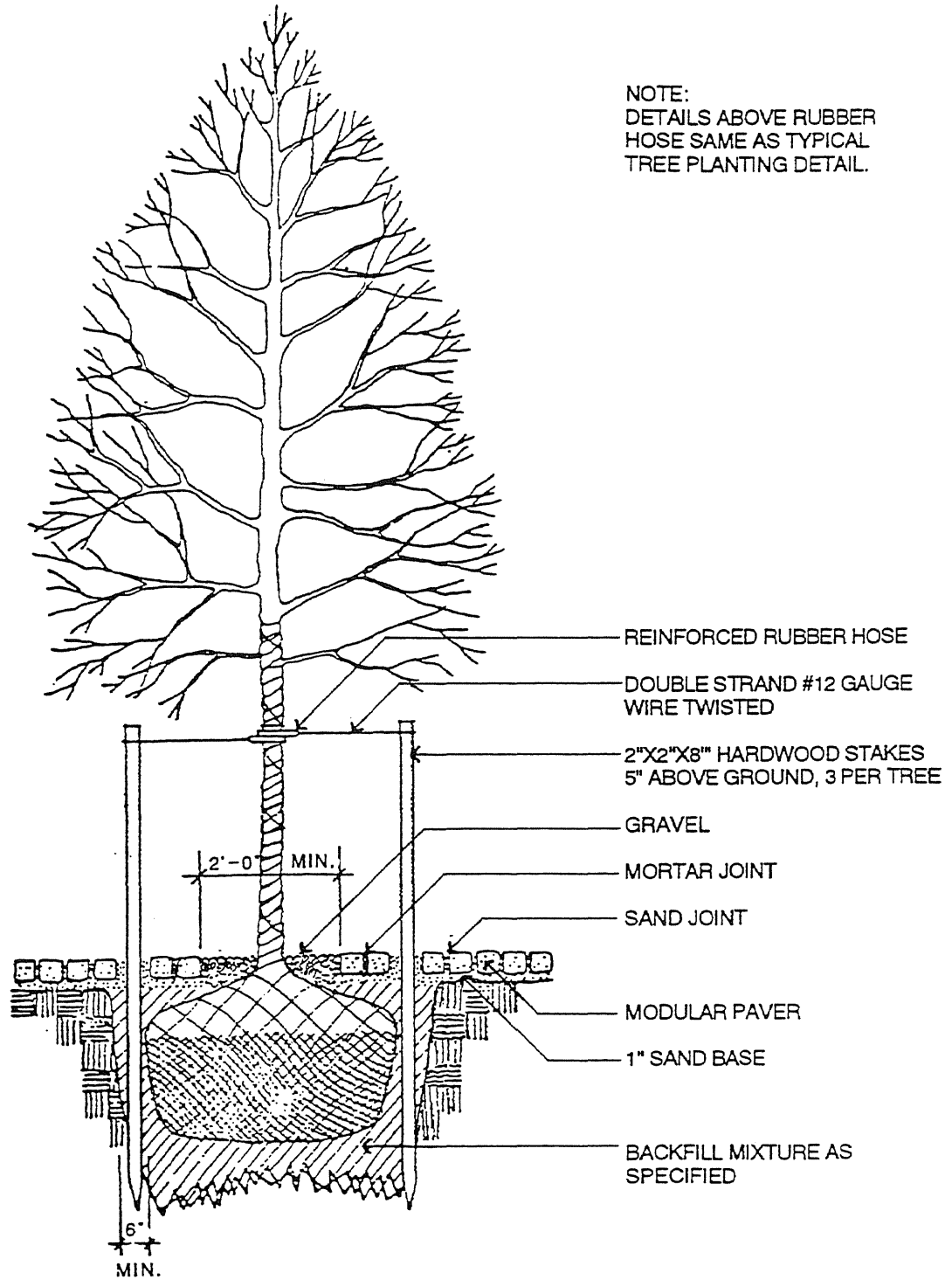

Typical Tree Planting Detail in Area of Modular Paving, Such as Granite Block



 Massachusetts Bay Transportation Authority  <b>RAILROAD OPERATIONS</b>	Commuter Rail Design Standards Manual	Stations and Parking	Section II
		<b>Landscaping</b>	Chapter 6
Revision No. 1	Date: 4/19/96		Page 6.19

Typical Tree Grates and Installation Detail

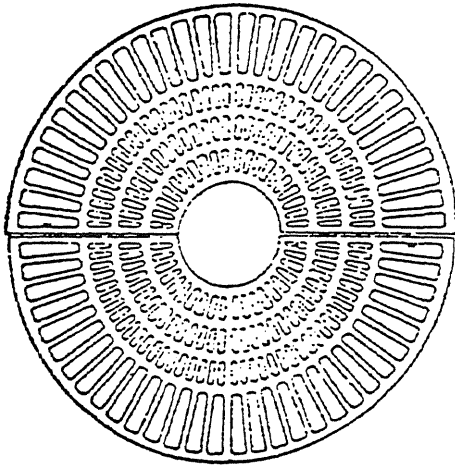

180° ROUND  
PREFERRED FOR CONCRETE,  
ASPHALT OR MODULAR PAVING  
WITHOUT A STRONG PATTERN

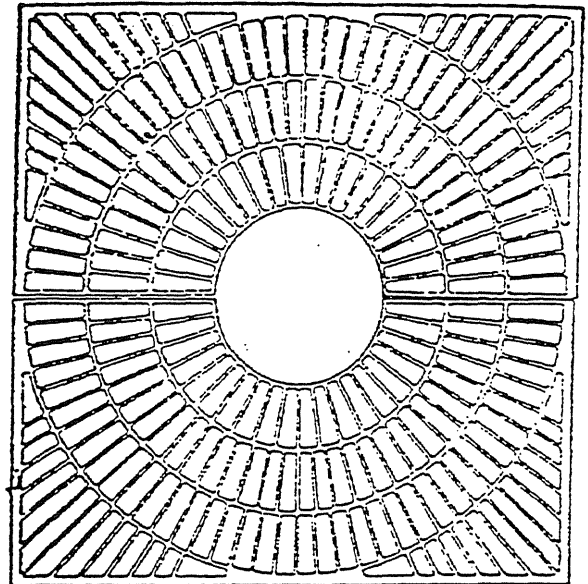

180° SQUARE  
PREFERRED FOR MODULAR  
PAVING WITH A STRONG  
RECTILINEAR PATTERN

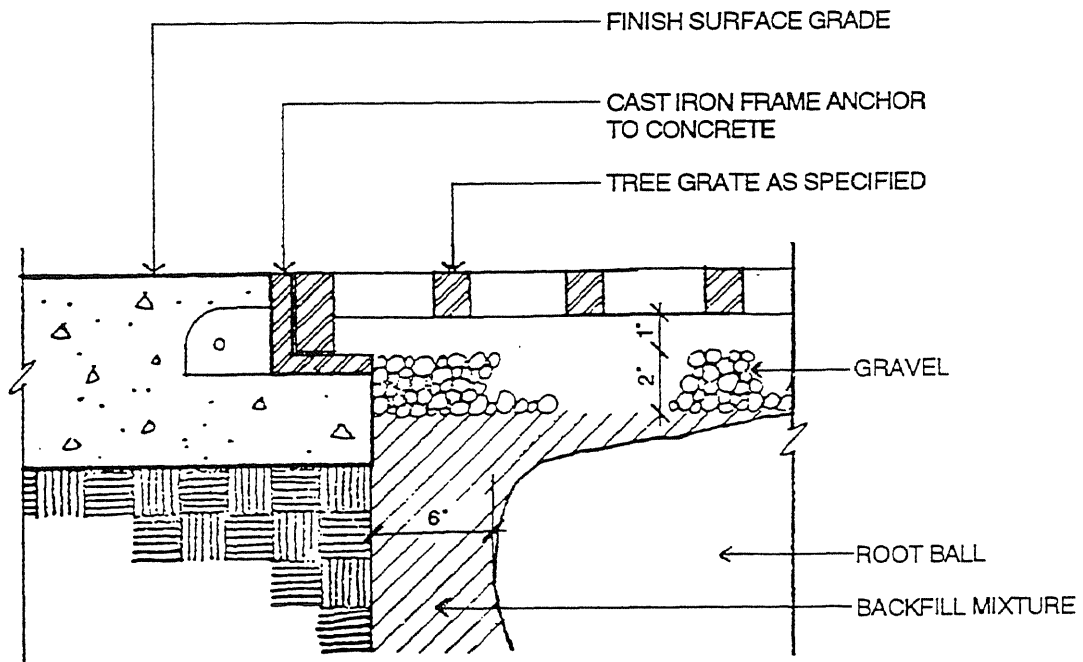

**MW1**



January 1, 1990

Maximum Allowable Operating Speeds on Curves													
Elevation in Inches (1-1/2 Underbalance) - <i>Continued</i>													
Degree Of Curve	0	1/2	1	1-1/2	2	2-1/2	3	3-1/2	4	4-1/2	5	5-1/2	6
	Speed in Miles per hour												
4°-00'	23	27	30	33	35	38	40	42	44	46	48	50	52
4°-30'	22	25	28	31	33	36	38	40	42	44	45	47	49
5°-00'	21	24	27	29	32	34	36	38	40	41	43	45	45
5°-30'	20	23	25	28	30	32	34	36	38	39	41	43	44
6°-00'	19	22	24	27	29	31	33	35	36	38	39	41	42
6°-30'	18	21	23	26	28	30	31	33	35	36	38	39	41
7°-00'	17	20	23	25	27	29	30	32	34	35	36	38	39
7°-30'	17	20	22	24	26	28	29	31	32	34	35	37	38
8°-00'	16	19	21	23	25	27	28	30	31	33	34	35	37
8°-30'	16	18	20	22	24	26	27	29	30	32	33	34	35
9°-00'	15	18	20	22	24	25	27	28	30	31	32	33	35
9°-30'	15	17	19	21	23	25	26	27	29	30	31	32	34
10°-00'	15	17	19	21	22	24	25	27	28	29	30	31	33

10

11

Track Surface	Class of Track					
	1	2	3	4	5	6
The runoff in any 31 feet of track at the end of a raise may not be more than - . . . . .	3-1/2"	3"	2"	1-1/2"	1"	1/2"
The deviation from uniform profile on either rail at the mid-ordinate of a 62-foot chord may not be more than - . . . . .	3"	2-3/4"	2-1/4"	2"	1-1/4"	1/2"
Deviation from designated elevation on spirals may not be more than - . . . . .	1-3/4"	1-1/2"	1-1/4"	1"	3/4"	1/2"
Variation in cross level on spirals in any 31 feet may not be more than - . . . . .	2"	1-3/4"	1-1/4"	1"	3/4"	1/2"
Uniform deviation from zero cross level at any point on tangent or from designated elevation on curves between spirals may not be more than - . . . . .	3"	2"	1-3/4"	1-1/4"	1"	1/2"
The difference in cross level between any two points less than 62 feet apart on tangent and curves between spirals may not be more than - . . . . .	3"	2"	1-3/4"	1-1/4"	1"	5/8"

§213.63 TRACK SURFACE  
 The surface of track shall be maintained within the limits prescribed in the following table:

January 1, 1990

**§213.11 RESTORATION OR RENEWAL OF TRACK UNDER TRAFFIC CONDITIONS.**

If, during a period of restoration or renewal, track is under traffic conditions and does not meet all of the requirements prescribed in this part, the work on the track must be under the continuous supervision of a person designated under §213.7(a) who has at least one year of supervisory experience in railroad track maintenance. The term "continuous supervision" as used in this section means the physical presence of that person at a job site. However, since the work may be performed over a large area, it is not necessary that each phase of the work be done under the visual supervision of that person.

**§213.13 MEASURING TRACK NOT UNDER LOAD.**

When track, not under load, is measured to determine compliance with the requirements of this part and rail movement under load is apparent, that apparent amount of rail movement must be added to the measurements taken.

**SUBPART B - ROADBED**

**§213.31 SCOPE**

This subpart prescribes minimum requirements for roadbed and areas immediately adjacent to roadbed.

**§213.33 DRAINAGE**

Each drainage facility under or immediately adjacent to the roadbed must be kept sufficiently free of obstructions to accommodate expected water flow for the area concerned.

**§213.34 ROADBED ENCROACHMENTS**

Any construction, or excavations or other activity on or about the roadbed which creates a condition not in conformance with the standard roadway section as shown on the standard plan must be protected by appropriate measures.

**§213.37 VEGETATION.**

Vegetation on railroad property which is on or immediately adjacent to roadbed must be controlled so that it does not:

- (a) Become a fire hazard to track-carrying structures;
- (b) Obstruct visibility of railroad signs and signals;
- (c) Interfere with railroad employees performing normal trackside duties;
- (d) Prevent proper functioning of signal and communications lines;
- (e) Prevent railroad employees from visually inspecting moving equipment from their normal duty stations.

**SUBPART C—TRACK GEOMETRY**

**§213.51 SCOPE.**

This subpart prescribes requirements for the gage, alignment, and surface of track, and the elevation of outer rails and speed limits for curved track.

**§213.53 GAGE.**

- (a) Gage is measured between the heads of rails at right angles to the rails in a plane five-eighths of an inch (5/8") below the top of the rail head.
- (b) The gage of track must not be less than 4-ft. 8-in., on either tangents or curves, regardless of the class of track.
- (c) The gage of track must not be more than that prescribed in the following table:

Class of Track	Maximum Speed (mph)	Tangent Track	Curved Track
	F-P		
1	10-15	4' 9-3/4"	4' 9-3/4"
2	25-30	4' 9-1/2"	4' 9-3/4"
3	40-60	4' 9-1/2"	4' 9-3/4"
4	60-80	4' 9-1/4"	4' 9-1/2"
5	70-100	4' 9"	4' 9-1/4"
6	70-100	4' 9"	4' 9"

**§213.55 ALINEMENT.**

Alignment may not deviate from uniformity more than the amount prescribed in the following table:

Class of Track	Maximum speed (mph) F-P	Tangent track:	Curved track:
		The deviation of the mid-offset from 62-ft. line <sup>1</sup> may not be more than	The deviation of the mid-ordinate from 62-ft. chord <sup>2</sup> may not be more than
1	10-15	5"	5"
2	25-30	3"	3"
3	40-60	1-3/4"	1-3/4"
4	60-80	1-1/2"	1-1/2"
5	70-90	3/4"	5/8"
6	70-100	1/2"	3/8"

<sup>1</sup> The ends of the line must be at points on the gage side of the line rail five-eighths of an inch (5/8") below the top of the rail head. Either rail may be used as the line rail, however, the same rail must be used for the full length of that tangential segment of track.

<sup>2</sup> The ends of the chord must be at points on, the gage side of the outer rail, five-eighths of an inch (5/8") below the top of the rail head.

**§213.11 RESTORATION OR RENEWAL OF TRACK UNDER TRAFFIC CONDITIONS.**

If, during a period of restoration or renewal, track is under traffic conditions and does not meet all of the requirements prescribed in this part, the work on the track must be under the continuous supervision of a person designated under §213.7(a) who has at least one year of supervisory experience in railroad track maintenance. The term "continuous supervision" as used in this section means the physical presence of that person at a job site. However, since the work may be performed over a large area, it is not necessary that each phase of the work be done under the visual supervision of that person.

**§213.13 MEASURING TRACK NOT UNDER LOAD.**

When track, not under load, is measured to determine compliance with the requirements of this part and rail movement under load is apparent, that apparent amount of rail movement must be added to the measurements taken.

**SUBPART B - ROADBED**

**§213.31 SCOPE**

This subpart prescribes minimum requirements for roadbed and areas immediately adjacent to roadbed.

**§213.33 DRAINAGE**

Each drainage facility under or immediately adjacent to the roadbed must be kept sufficiently free of obstructions to accommodate expected water flow for the area concerned.

**§213.34 ROADBED ENCROACHMENTS**

Any construction, or excavations or other activity on or about the roadbed which creates a condition not in conformance with the standard roadway section as shown on the standard plan must be protected by appropriate measures.

**§213.37 VEGETATION.**

Vegetation on railroad property which is on or immediately adjacent to roadbed must be controlled so that it does not:

- (a) Become a fire hazard to track-carrying structures;
- (b) Obstruct visibility of railroad signs and signals;
- (c) Interfere with railroad employees performing normal trackside duties;
- (d) Prevent proper functioning of signal and communications lines;
- (e) Prevent railroad employees from visually inspecting moving equipment from their normal duty stations.

**SUBPART C—TRACK GEOMETRY**

**§213.51 SCOPE.**

This subpart prescribes requirements for the gage, alignment, and surface of track, and the elevation of outer rails and speed limits for curved track.

**§213.53 GAGE.**

- (a) Gage is measured between the heads of rails at right angles to the rails in a plane five-eighths of an inch (5/8") below the top of the rail head.
- (b) The gage of track must not be less than 4-ft. 8-in., on either tangents or curves, regardless of the class of track.
- (c) The gage of track must not be more than that prescribed in the following table:

Class of Track	Maximum Speed	Tangent Track	Curved Track
	(mph) F-P		
1	10-15	4' 9-3/4"	4' 9-3/4"
2	25-30	4' 9-1/2"	4' 9-3/4"
3	40-60	4' 9-1/2"	4' 9-3/4"
4	60-80	4' 9-1/4"	4' 9-1/2"
5	70-100	4' 9"	4' 9-1/4"
6	70-100	4' 9"	4' 9"

**§213.55 ALINEMENT.**

Alignment may not deviate from uniformity more than the amount prescribed in the following table:

Class of Track	Maximum speed (mph) F-P	Tangent track:	Curved track:
		The deviation of the mid-offset from 62-ft. line <sup>1</sup> may not be more than	The deviation of the mid-ordinate from 62-ft. chord <sup>2</sup> may not be more than
1	10-15	5"	5"
2	25-30	3"	3"
3	40-60	1-3/4"	1-3/4"
4	60-80	1-1/2"	1-1/2"
5	70-90	3/4"	5/8"
6	70-100	1/2"	3/8"

<sup>1</sup> The ends of the line must be at points on the gage side of the line rail five-eighths of an inch (5/8") below the top of the rail head. Either rail may be used as the line rail, however, the same rail must be used for the full length of that tangential segment of track.

<sup>2</sup> The ends of the chord must be at points on, the gage side of the outer rail, five-eighths of an inch (5/8") below the top of the rail head.

**§213.57 CURVES; ELEVATION AND SPEED LIMITS.**

- (a) The outer rail of a curve may not be lower than the inner rail, except as provided in §213.63 and through turnouts, crossovers and track crossings in elevated curved tracks when authorized by the Chief Engineering Officer.
- (b) Curves shall be surfaced to not more than six inches (6") elevation unless authorized by the Chief Engineering Officer.
- (c) The maximum allowable operating speed for each curve must not produce an underbalance in excess of one and one-half inches (1-1/2"), unless authorized by the Chief Engineering Officer.
- (d) Curves within station limits shall not have more than one inch elevation.
- (e) The following table gives maximum allowable speeds for passenger and freight trains for various degrees of curvature and various amounts of elevation. The speeds shown in this table are based on the operation of trains at one and one-half inches (1-1/2") of underbalance and must not be exceeded unless authorized by the Chief Engineering Officer.

**§213.59 ELEVATION OF CURVED TRACK; RUNOFF.**

- (a) If a curve or segment of a compound curve is elevated, the full elevation must be provided between points of full curvature, throughout the curve unless physical conditions do not permit. If the elevation does not extend throughout the curve or segment of a compound curve, the minimum elevation must be used in determining the maximum allowable operating speed.
- (b) Elevation runoff must be at a uniform rate, within the limits of track surface deviation prescribed in §213.63, and it must extend at least the full length of the spiral. If physical conditions do not permit a spiral long enough to accommodate the minimum length of runoff, a maximum of one (1) inch elevation may be run off on tangent track.

**§213.61 CURVE DATA FOR CLASS 2 THROUGH 6 TRACK**

A record shall be maintained at each curve in classes 2 through 6 track. The record must contain the following information:

- (a) Location; TS, SC, CS, ST
- (b) Degree of curvature;
- (c) Designated elevation;
- (d) Designated length of elevation runoff; and
- (e) Maximum allowable operating speed.

January 1, 1990

Degree Of Curve	Maximum Allowable Operating Speeds on Curves												
	Elevation in Inches (1-1/2 Underbalance)												
	0	1/2	1	1-1/2	2	2-1/2	3	3-1/2	4	4-1/2	5	5-1/2	6
0°-10'	110	103	110	106	110	103	108	110	105	109	110	103	110
0°-20'	80	85	93	93	100	106	98	89	96	100	103	96	103
0°-30'	65	73	80	80	87	93	88	79	86	89	93	86	89
0°-40'	57	65	73	72	77	83	88	72	76	83	83	79	82
0°-50'	51	59	65	65	71	76	80	69	76	83	83	79	82
1°-00'	46	53	60	65	71	76	80	64	70	76	76	73	76
1°-15'	41	48	53	59	63	68	72	60	65	68	71	68	73
1°-30'	38	44	49	53	58	62	65	59	62	64	67	64	71
1°-45'	35	40	45	49	53	57	61	60	63	65	68	67	73
2°-00'	33	38	42	46	50	53	57	56	59	62	64	61	69
2°-15'	31	36	40	44	47	50	53	56	59	62	64	61	69
2°-30'	29	34	38	42	45	48	51	53	56	59	61	63	65
3°-00'	27	31	35	38	41	44	46	49	51	53	56	58	59
3°-15'	26	30	33	36	39	42	44	47	49	51	53	55	57
3°-30'	25	29	32	35	38	40	43	45	47	49	51	53	55
3°-45'	24	28	31	34	37	39	41	44	46	48	50	52	53